

Ci5160REFM-THX Architectural Speaker

KEF's first THX® Certified Dominus speaker

A state-of-the-art architectural speaker in KEF's flagship The Reference range, the in-wall Ci-Reference architectural speaker Ci5160REFM-THX delivers the might and magic of pure accurate sound and brings a thrillingly immersive audio experience for movies and music at home. The KEF engineering team in Maidstone, UK has once again pushed the limits of technology to deliver a world class speaker that not only meets the standards set by The Reference, but also the largest and most powerful THX® performance class – THX® Certified Dominus. Ci5160REFMTHX is KEF's first in-wall speaker to THX® Certified Dominus among the very few that can achieve this ultimate standard worldwide. It is the closest approximation to a public cinema experience that you can achieve in your own home. Being THX® Certified Dominus means what you hear was what meant to be heard. The quiet whisper, that loud explosion, and everything in between.

Together with innovative technologies including the 12th generation Uni-Q driver array with Metamaterial Absorption Technology¹ (MAT™), Ci5160REFM-THX delivers an immersive, high-fidelity soundstage with unmatched sonic excellence even for large home theatres and living rooms.

The benchmark of benchmarks

Since its launch in 1973, The Reference has redefined the standard to be the benchmark and continually set the benchmark for loudspeakers through the pioneering use and constant evolution of digital technologies. The Reference series is created in the pursuit of the perfect reproduction of recorded sound to achieve the highest possible audio accuracy. Every speaker in The Reference series is meticulously hand-assembled, with each one rigorously tested against the laboratory maintained line standard by KEF's highly trained expert craftspeople.

Ci-Reference speakers are built to the same exacting standards as the rest of The Reference series and are optimised for in-wall application. The range has been upgraded with the latest technological advances including the revolutionary 12th generation Uni-Q driver array with MAT and in-wall bass drivers, which are specially designed for this model, to deliver realistic and immersive sound with breath-taking dynamics for the most discerning music and movie lovers.

12th Generation Uni-Q® driver array with MAT™

At the heart of Ci5160REFM-THX sits the latest example of KEF's signature driver array - Uni-Q. Now in its 12th generation, this remarkable feat of engineering acts as a point source, dispersing sound more evenly allowing everyone to experience the same natural detailed sound, wherever in the room they are.

The Ci5160REFM-THX also benefits from another groundbreaking acoustic innovation: Metamaterial Absorption Technology (MAT). MAT is a highly complex maze-like structure that absorbs 99% of the unwanted sound from the rear of the tweeter, delivering a crisper, more natural treble performance.

Reference-quality sound

Ci5160REFM-THX delivers a clean, rich, highly articulate bass, thanks to the two 160mm (6.5in.) bass drivers. Designed specifically for the in-wall environment, the massive, vented motor system handles significant amounts of raw power.

Simultaneously, the smart engineering and fine nuances of the driver design blend seamlessly into the Uni-Q driver array, making Ci5160REFM-THX a truly unified speaker, disappearing into the room, leaving an awe-inspiring, immersive experience.

Total attention to detail

Every Ci-Reference speaker is a statement of quality, with total attention to detail that comes from being hand-crafted by KEF's masters in Maidstone, UK. Each is designed to be both acoustically and visually exceptional, and meticulously built to KEF's superlative standards.

The 11mm thick, precision-machined aluminium baffle of Ci5160REFM-THX is not only a mark of quality and aesthetic excellence, but also engineered to eliminate vibration and provides a stoic platform for the drivers to perform at their best.

Surrounding the Uni-Q driver array is the Shadow Flare – another example of form following function. A precision-made trim ring perfectly transitions sound from the driver into the room, eliminating diffraction effects.

Hide your speakers, not your sound

'Hide your speakers, not your sound' is the concept behind KEF's comprehensive range of architectural speakers. Ci5160REFM-THX is engineered with best-in-class acoustic performance and designed to be discreet in appearance with the paintable magnetic metal grille, delivering an immersive soundscape via speakers that blend into the interior. Available in Aluminium Black/Grey, a hairline finished aluminium baffle in black, with the Uni-Q driver array in grey. Optional black cloth grille is available.



Summary of features

- KEF's first THX® Certified Dominus speaker – the largest and most powerful THX performance class
- Metamaterial Absorption Technology eliminates 99% of high-frequency distortion for pure, natural sound
- Bespoke 12th generation Uni-Q with MAT driver array for exceptional acoustic accuracy
- Four 160mm (6.5in.) bass drivers optimised for in-wall use
- 11mm thick precision-machined aluminium baffle designed to eliminate vibration and allows the drivers to perform at their best
- Designed to be discreet in appearance
- Available in Aluminium Black/Grey finish
- Paintable magnetic metal grille that fits effortlessly into the interior
- Optional black cloth grille available as separate item



Specifications

Model	Ci5160REFM-THX	
Series	Ci-Reference	
Nominal impedance	4Ω	
Sensitivity (2.83V/1m)	92dB	
Frequency response (±6dB) open-backed	40Hz - 28kHz	
Frequency range (-10dB)	32Hz - 45kHz	
Nominal coverage (degrees)	150°	
Max SPL (dB)	116dB	
Crossover frequency	600Hz, 3kHz	
Drive units	LF	4 x 160mm (6.5in.)
	MF	125mm (5.25in.) Uni-Q
	HF	25mm (1in.) vented aluminium dome with Metamaterial Absorption Technology ¹
Recommended amplifier power	50 - 500W	
Recommended high-pass filter (Hz)	35 - 80Hz	
Product external dimensions (H x W x D)	1070 x 230 x 105.7mm (42.13 x 9.06 x 4.16in.)	
Cut-out dimensions (H x W)	1052 x 209mm (41.42 x 8.23in.)	
Net Weight	21.7kg (47.8lbs.)	
Mounting depth from surface	99mm (3.9in.)	
Optional rough in frame	RIF5160L	
Ideal rear volume	90L	
Minimum rear volume	40L	
THX certification	THX [®] Certified Dominus	
Safety and Regulatory Compliance	NA	
Wall thickness (Maximum)	40mm (1.58in.)	
Wall thickness (Minimum)	6mm (0.24in.)	



¹ Metamaterial Absorption Technology is a joint development with Acoustic Metamaterials Group.

Visit [KEF.COM](https://www.kef.com) for more about KEF and its products.

KEF reserves the right, in line with continuing research and development, to amend or change specifications. E&OE. The Ci speakers that utilise THX in the model name have undergone and passed THX Certified approval.

Directivity Index

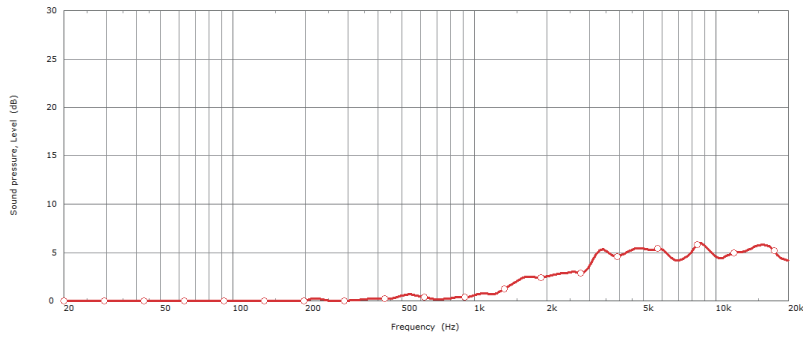

Beamwidth -3dB

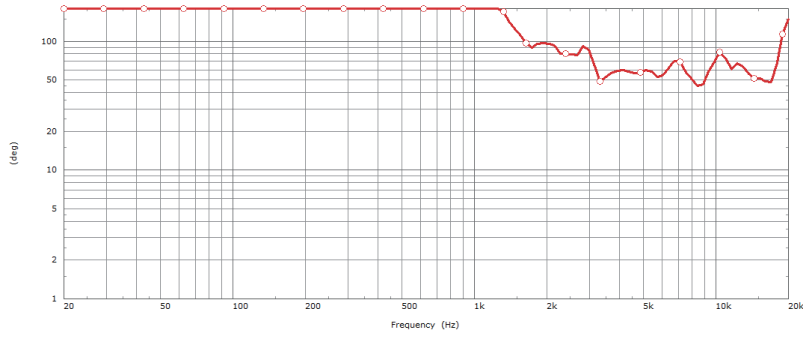

Beamwidth -6dB

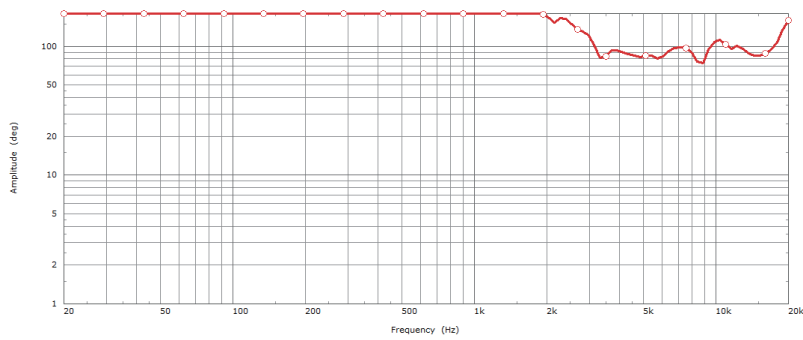

Impedance

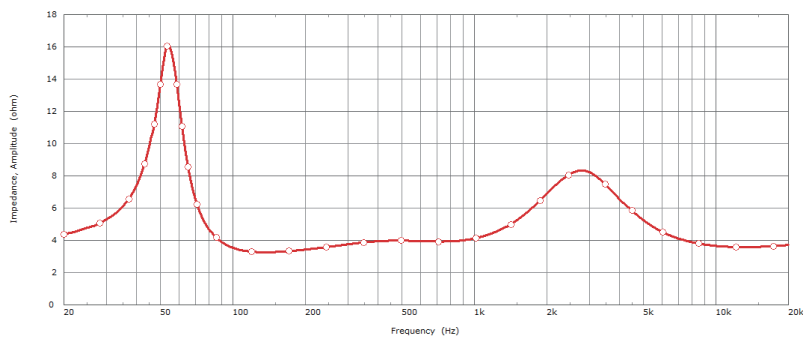

Sensitivity (2.83V/1m)

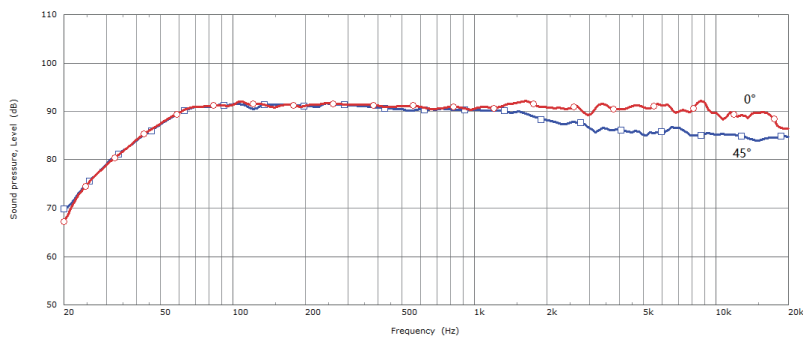

Polar Responses

Polar 63Hz

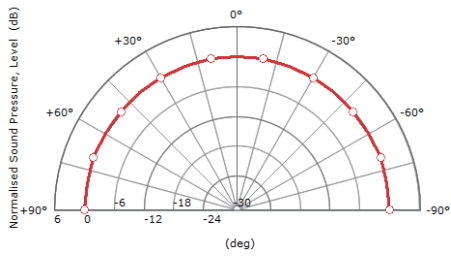

Polar 125Hz

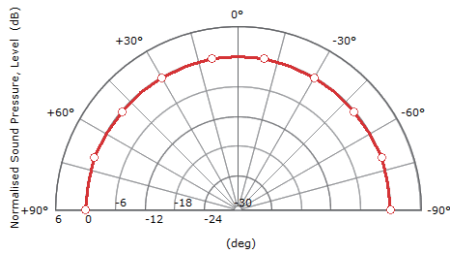

Polar 250Hz

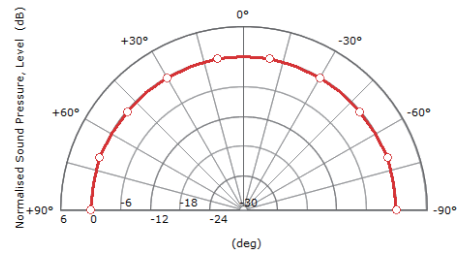

Polar 500Hz

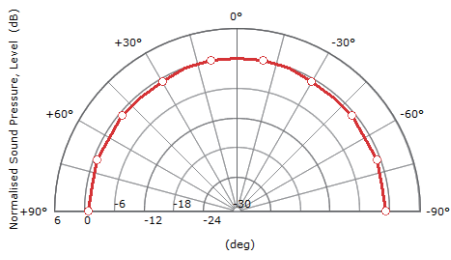

Polar 1kHz

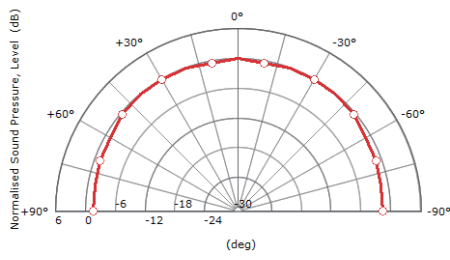

Polar 2kHz

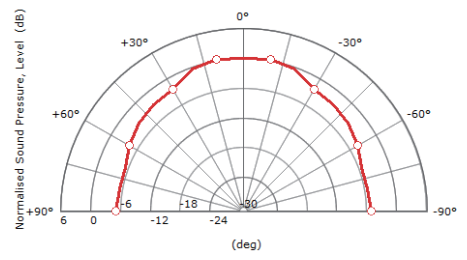

Polar 4kHz

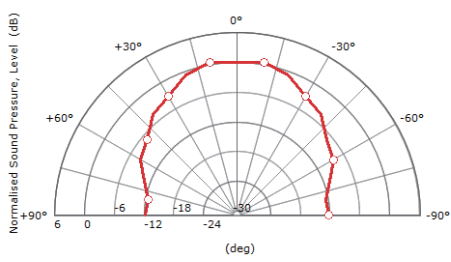

Polar 8kHz

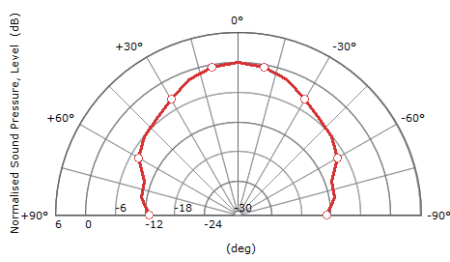

Polar 16kHz

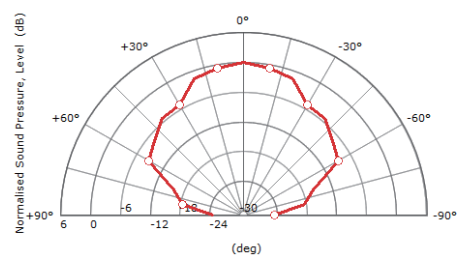

Mechanical Diagrams

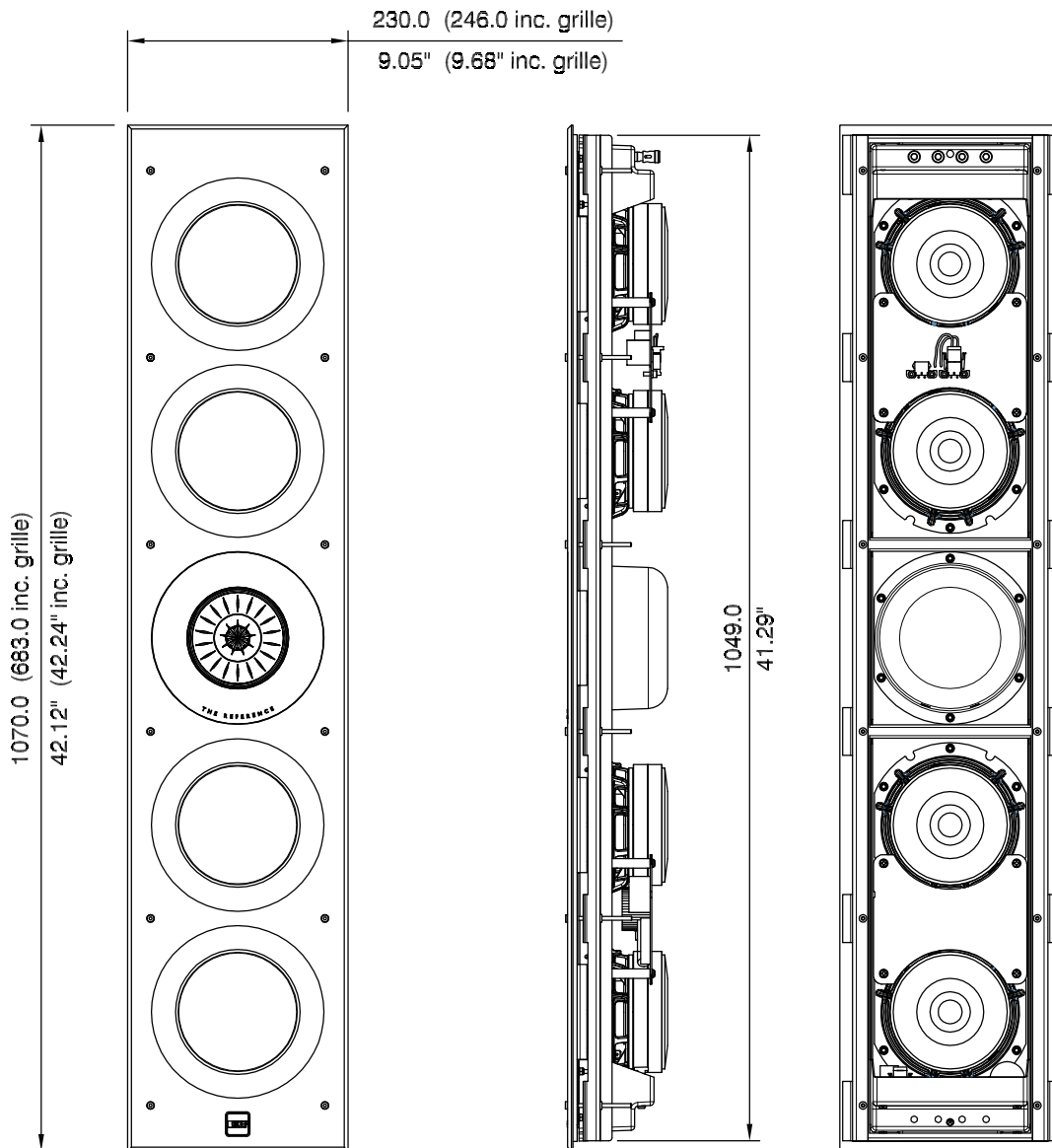
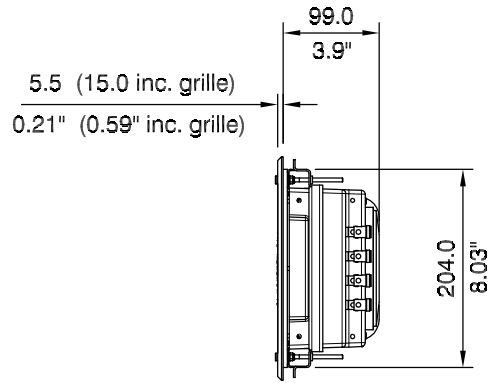

Dimensions in mm (inches)

KEF reserves the right, in line with continuing research and development, to amend or change specifications. E&OE.