

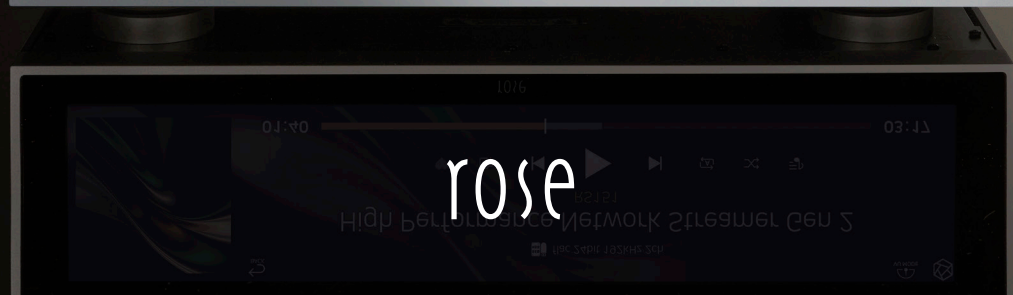

Beyond Audio, **HiFi ROSE**

High Performance Network Streamer Gen 2, **RS151**







rose

rose

rose

rose



High Performance Network Streamer Gen 2, RS151

- Flagship Network Streamer
- Network Transport + DAC
- Advanced DAC Design with Extremely Low Noise and Distortion
- ROSE DPC™ (Digital Processing Core) Module
- ROSE NRA™ (Noise Reduction Analog) Filter for Flat and Wide Frequency Response
- Highly Precise Femto Clock
- Linear Power Supply for Significant Noise Reduction

Hi-Res	DSD	Native DSD 512	In/Out Port	Analog In	Line In
	PCM	32bit/768kHz		Analog Out	Unbalanced, Balanced
In/Out Port	Digital In	USB 2.0 Type-B, Optical, Coaxial, AES/EBU, HDMI eARC	Network Connection	HDMI Out	4K
	Digital Out	USB 3.0 Type-A, Optical, Coaxial, AES/EBU, I ² S-HDMI		Ethernet	10/100/1000 BASE-T
				Wi-Fi	USB Dongle
				Bluetooth	V.5.4 AptX

Connectivity Bluetooth, DLNA, AirPlay, Spotify Connect, Roon Ready

Design 430*319*125 mm / 11 kg / 15.4" Wide viewing angle touch screen / Color: Black, Silver



Absolute True Fidelity DAC RD160

- ROSE DPC™ (Digital Processing Core) Module
- ROSE CIM™ (Completely Isolated & Moduled) Architecture
- Three Independently Customized Reference Linear Power Supply Units
- ROSE NRA™ (Noise Reduction Analog) Filter for Flat and Wide Frequency Response
- High-Precision OCXO Clock for Long-Term Jitter Reduction
- Lavish Internal Wiring with High-Purity OFC and OCC
- Fiber Optic USB Connectivity

Hi-Res	DSD	Native DSD 512
	PCM	32bit/768kHz
In/Out Port	Digital In	USB SFP, USB 2.0 Type-B, Optical, Coaxial 1(RCA), Coaxial 2(BNC), AES/EBU, I ² S-HDMI
	Analog Out	Unbalanced, Balanced
	Clock In	BNC 75Ω, SMA 50Ω

Design 430*330*88 mm / 10 kg / Aluminum, Rust-proof Steel / Color: Black, Silver



Top-notch Master Integrated Amplifier RA280

- Class AD Amplifier with Next-Generation GaN FET
- Independently Developed LC Filter by HiFi ROSE
- Highly Efficient and Stable Power Supply
- Powerful 250W Output
- Phono Amplifier for MM
- Bass/Treble Control Volume

In/Out Port	Analog In	LINE1, LINE2, LINE3, BALANCED, PHONO(MM)
	Analog Out	Sub Woofer
Speaker Out	Stereo	250W x 2ch(4Ω, 8Ω)

Design 430*355*110 mm / 9.5 kg / Aluminum, Rust-proof Steel / Color: Black, Silver



Ultimate Network Transport RS130

- Linear Power Supply Utilizing Supercapacitor for Battery-Level Noise Reduction
- High-Precision OCXO Clock for Long-Term Jitter Reduction
- External Master Clock Input
- Network Streaming with SSD Caching Playback
- Fiber Optic Ethernet & USB Connectivity

Hi-Res	DSD	Native DSD 512	Network Connection	Ethernet	10/100/1000 BASE-T (SFP COPPER Type)
	PCM	32bit/768kHz			
In/Out Port	Digital Out	USB 2.0 Type-A, Optical, Coaxial, AES/EBU, I ² S-HDMI		Wi-Fi	USB Dongle
	Clock In	BNC 75Ω, 50Ω		Bluetooth	USB Dongle V.4.2
	HDMI Out	4K			

Connectivity Bluetooth, DLNA, AirPlay, Spotify Connect, Roon Ready

Design 430*317*125 mm / 12 kg / 15.4" Wide viewing angle touch screen / Color: Black, Silver



Advanced All-In-One Network Streamer RS520

- Reference Grade Network Streaming All-in-One
- Network Transport + DAC + Class AD Amplifier with Next-Generation GaN FET
- High-Resolution Music Playback (DSD512, PCM 32bit/768kHz)
- Highly Precise Femto Clock
- Linear Power Supply for Significant Noise Reduction

Hi-Res	DSD	Native DSD 512	In/Out Port	HDMI Out	4K
	PCM	32bit/768kHz		Speaker Out	250W x 2ch(4Ω, 8Ω)
In/Out Port	Digital In	USB 2.0 Type-B, Optical, Coaxial, HDMI eARC	Network Connection	Ethernet	10/100/1000 BASE-T
	Digital Out	USB 3.0 Type-A, Optical, Coaxial		Wi-Fi	USB Dongle
	Analog In	Line In		Bluetooth	USB Dongle V.4.2
	Analog Out	Unbalanced			

Connectivity Bluetooth, DLNA, AirPlay, Spotify Connect, Roon Ready

Design 346*328*127 mm / 8.1 kg / 12.6" Wide viewing angle touch screen / Color: Black, Silver



Absolute Pure Sound Integrated Amplifier RA180

- Class AD Amplifier with Next-Generation GaN FET
- Multi-Output Component
- Designed to Play Up to the Super Tweeter Realm
- Balanced Power Supply
- Phono Amplifier with Variable EQ

In/Out Port	Analog In	LINE1, LINE2, LINE3(Bypass), BALANCED, PHONO(MM/MC)
	Analog Out	Sub Woofer
Speaker Out	Stereo(A/B)	200W x 4ch(8Ω)
	Stereo(A), BTL(B)	Stereo(A): 200W x 4ch(8Ω) / BTL(B): 400W x 2ch(8Ω)
	BTL(A/B)	BTL(A): 400W x 2ch(8Ω) / BTL(B): 400W x 2ch(8Ω)

Design 430*391*124 mm / 16.7 kg / Aluminum, Rust-proof Steel / Color: Silver



Complete HiFi Network Streamer RS250A

- Reference Grade Network Streamer
- Network Transport + DAC
- High-Resolution Music Playback (DSD512, PCM 32bit/768kHz)
- Highly Precise Femto Clock
- Linear Power Supply for Significant Noise Reduction

Hi-Res	DSD	Native DSD 512	In/Out Port	HDMI Out	4K	
	PCM	32bit/768kHz		Headphone Out	3.5mm	
In/Out Port	Digital In	USB 2.0 Type-B, Optical, Coaxial	Network Connection	Ethernet	10/100/1000 BASE-T	
	Digital Out	USB 3.0 Type-A, Optical, Coaxial		Wi-Fi	802.11 a/b/g/n/ac (2.4GHz/5GHz)	
	Analog In	Line In		Bluetooth		V4.0 / V3.0+HS
	Analog Out	Unbalanced				

Connectivity Bluetooth, DLNA, AirPlay, Spotify Connect, Roon Ready

Design 278*231*83 mm / 3.2 kg / 8.8" Wide viewing angle touch screen / Color: Black, Silver



HiFi ROSE USB Fiber Optical Hub RSA720

- Compact Design Maximizing Usability and Functionality
- Optical USB Port
- Supports USB 3.0/2.0 via Four Independent USB Ports
- Guaranteed Stable Data Transmission Speed
- Supports Long-Distance Transmission

Input USB 3.0 Type-B, SFP(10G)

Output USB 3.0-2ports, USB 2.0-2ports

Design 152*153.5*33.5 mm / 1.2 kg / Color: Silver



HiFi ROSE CD Drive RSA780 Series

- USB Isolator Adopted to Block Motion Noise
- USB Type-B Port for HiFi Audio
- 900g Weight for Stable CD Playback
- Minimized Motion Noise with Insulators
- CD Ripping Features Included

Rear USB Type-B

Design 152*152*25 mm / 0.9 kg / Color: Silver



Innovative ROSE OS System



TIDAL

Enjoy music streaming and videos with TIDAL's unique features. Supports MQA Full Decoder, so you can enjoy high-resolution music.



ROSE Tube

You can enjoy all content and music on YouTube.



Spotify Connect

Spotify Connect allows you to play and wirelessly control Spotify music on your ROSE OS over a network. With the Spotify Connect function, you can enjoy a variety of music with HiFi sound quality on your ROSE device.



Roon Ready

ROSE OS is fully compatible with Roon Core, with Roon Ready certification in compliance with all requirements of Roon Labs. You can enjoy HiFi sound quality on your ROSE device with the powerful music management capabilities of Roon.



Hi-Res Audio

HiFi ROSE devices are certified with a 'High-Resolution Audio' license from the JAS (Japan Audio Society).



4K Video

You can enjoy high-definition videos on YouTube, TIDAL, and Bugs, and play video files in various formats.



Play CD

Play CDs by connecting an external USB CD-ROM.



CD Ripping

Rip CDs by connecting an external USB CD-ROM and save them on a storage device.



Qobuz

Enjoy music streaming with Qobuz's various functions. Support for Hi-Res Audio(24bit/192kHz) means you can enjoy high-resolution music.



Apple Music App

Enjoy curated playlists divided by Apple Music's own musical tastes. You can enjoy various tracks in Apple Music.



Audirvana

Enjoy the immersive world of high-resolution music with Audirvana. You can experience the depth of your favorite tracks.



ROSE Radio

Enjoy Rose Radio, which consists of about 30,000 radio channels from 200 countries around the world. Channels are organized into various categories, and you can easily search for channels with filters of genre/region/language.



File Manager

You can perform file and folder management tasks, such as moving, copying, and deleting, on storage device.



MQA

Supports MQA's Full Decoder. Enjoy studio mastering sound quality.



Clock

Various design clock functions are provided, such as alarms and weather information.



Music Library

Manage your music files under various categories, such as albums, artists, and genres.



My Playlist

Create your own playlist. You can also register your friends and share it with them.

ROSE Connect Remote Application

A dedicated Remote App is provided that allows users to conveniently control and smartly manage their ROSE device. The Remote App is supported on various platforms, including the iPhone, iPad, Android phone, and PCs.

Control

You can freely and conveniently control various HiFi ROSE functions wirelessly.

Control You can control a variety of functions remotely including Music, ROSE Tube, TIDAL, Qobuz, Radio, Apple Music and CD Ripping.

Remote ROSE Connect includes the remote control function.

Search You can conveniently search for a variety of music in the Media Library.

Streaming

You can simply and easily play music stored on your phone on your ROSE device. Enjoy a lossless, high-quality streaming service.

Playlist

You can create your own playlist.

Make a playlist on Music and ROSE Tube and check it out at Home - My Music.

Share with Friends

You can share your playlists with your friends or listen to music recommended by them. Communicate with your friends through music.

Media Library

Scan the music in your local memory to organize it into various categories.

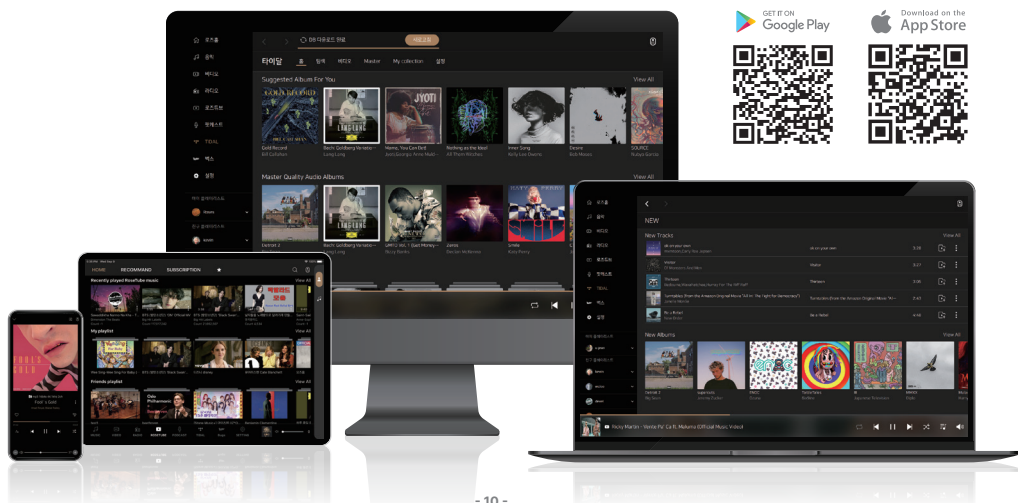

OWNER'S MANUAL

RS151 Product User Manual

Table of Contents

Safety Precautions	14
1. Warnings	14
2. Precautions	15
Components List	16
Location / Function of Buttons and Ports	17
1. Front Side of the Product	17
2. Rear Side of the Product	18
3. Remote Control	19
Product Installation	20
1. Product Design Method and Recommended Installation Location	20
2. How to Connect the Power Cord	21
3. How to Properly Connect Rear Ports and Cables	22
3-1. Connection Between Analog Output Port and Power Amplifier or AV Receiver	
3-2. Connection Between Analog Input Port and Audio Device	
3-3. Connection Between Analog In/Out port Port and Audio Device (TV or Devices That Provide Digital Input / Output Capabilities)	
3-3-1. OPTICAL/COAXIAL	
3-3-2. AES/EBU	
3-3-3. eARC IN	
3-3-4. I ² S OUT	
3-4. HDMI Connection	
3-5. PC AUDIO Connection	
3-6. Connection Between USB Audio Output Port and External Device	
3-7. Connection Between USB Audio Output Port and External DAC	
3-8. USB WiFi Connection	
3-9. Circuit Breaker	
3-10. GND Connection	
4. External Memory Devices(USB) and SATA Storage Devices	33
5. How to Connect SSD	34
5-1. How to Insert SSD	
5-2. How to Format after Installing SSD	
5-3. How to Copy Files Through the Network	
6. Network Connection	36
6-1. Ethernet Connection(Wired)	
6-2. WiFi Connection(Wireless)	
7. How to Connect to RoonReady	38

Default Settings	40
1. Power Button	40
2. In/Out Setting	40
2-1. INPUT	
2-1-1. RS151	
2-1-2. AES/EBU IN	
2-1-3. BT IN	
2-1-4. USB IN	
2-1-5. eARC IN	
2-1-6. LINE IN	
2-1-7. COAX IN	
2-1-8. OPT IN	
2-2. OUTPUT	
2-2-1. USB DAC	
2-2-2. HDMI	
2-2-3. Digital (AES/EBU OUT, I ² S OUT(HDMI), OPT OUT, COAX OUT)	
2-2-4. Analog (UNBALANCED R/L, BALANCED R/L)	
Playback	53
1. Default Playback	53
2. Media Library	53
2-1. Activate Media Scanning	
2-2. After Media Scanning	
Supplementary Information	55
1. Firmware Update	55
1-1. Run OTA Update	
1-2. Update Via Settings Menu	
1-3. How to Install the Firmware When the XMOS / MCU Update Pop-Up Occurs	
1-3-1. If there is only an XMOS update	
1-3-2. If there is only a MCU update	
1-3-3. If there is XMOS update and MCU update	
2. Factory Reset	58
Product Specifications	60
Quality Guaranteed	62

Safety Precautions





1. Warnings

1. Do not apply excessive force on the product, throw it, or strike it with sharp objects.
2. Children should only use the product under adult supervision to ensure proper usage.
3. Use within a temperature range of 0°C to 40°C and do not use in hot or humid conditions. Install the product in a well-ventilated area, not an enclosed space. The product may break, corrode, overheat, or catch fire in an environment below 0°C or in a sealed environment with a high temperature, such as a sauna. Moisture or liquid can also damage the surface of the product and its circuit components.
4. Be sure to use a genuine power cable provided by ROSE. Any other cable may cause operational errors or damage (decreased performance) to the product.
5. Do not spill dirt or liquid on the product. It may damage the components and circuits. If the product gets wet, do not turn it on and contact your nearest service center. However, free repairs are not available in this case.
6. Do not connect antennas or accessories that are not certified by ROSE to the product.
7. Please install this product at least 1 m (3 ft) away from devices that may cause radio interference (wireless routers, microwave ovens, etc.). Noise may be generated by electromagnetic waves.
8. This device complies with part 15 of the FCC Rules. Operation is subject to the following two conditions:
 - This device may not cause harmful interference.
 - This device must accept any interference received, including interference that may cause undesired operation.
9. This equipment has been tested and found to comply with the limits for a Class B digital device, pursuant to part 15 of the FCC Rules. These limits are designed to provide reasonable protection against harmful interference in a residential installation. This equipment generates, uses and can radiate radio frequency energy and, if not installed and used in accordance with the instructions, may cause harmful interference to radio communications. However, there is no guarantee that interference will not occur in a particular installation. If this equipment does cause harmful interference to radio or television reception, which can be determined by turning the equipment off and on, the user is encouraged to try to correct the interference by one or more of the following measures:
 - Reorient or relocate the receiving antenna.
 - Increase the separation between the equipment and receiver.
 - Connect the equipment into an outlet on a circuit different from that to which the receiver is connected.
 - Consult the dealer or an experienced radio/TV technician for help.
10. Changes or modifications not expressly approved by the party responsible for compliance could void the user's authority to operate the equipment.
11. This device should be installed and operated with minimum 20 cm between the radiator and your body.

2. Precautions

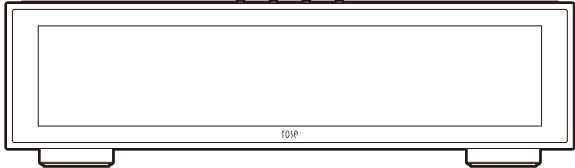
1. The contents of the owner's manual are described based on the default settings of the product.
2. Some contents of this manual may be changed without prior notice to the user in order to improve product performance.
3. The features and additional services of the product may vary depending on the country, software specifications, and policy changes of the service provider.
4. Repairs due to user negligence or product failure may erase user data (music files, video files, etc.). ROSE is not responsible for any damage or loss of data.
5. If you use Bluetooth and 2.4GHz band wireless LAN together, the WiFi connection may be slow or audio playback through Bluetooth may not work properly due to signal interference. If you are using them at the same time, we recommend using wireless LAN connections in the 5GHz band.
6. Do not use chemical solutions (alcohol, thinner, solvents, etc.) or detergent to clean the product. Rubbing the product with a chemical solution can create heat and cause the product to catch fire. When cleaning the product, wipe it with a soft cloth or towel.
7. Do not disassemble, modify or repair the product on your own. If you do, you will no longer qualify for free repairs. If a malfunction occurs because of this, contact an authorized service center for repairs.
8. Only programs provided by the manufacturer are available. Transferring independently created files or user-modified files to the product can cause operational errors or cause serious problems with the product. ROSE is not responsible for any problems that arise in this case.
9. If the touch screen is damaged, do not touch it with your hands. Contact the service center immediately, as it may cause injury.
10. When you're not going to use the product for a long time, be sure to unplug the power plug from the AC outlet. Even after the power has been shut off (manual standby mode), a minimal current remains in the equipment. Remove the plug to prevent power consumption.
11. After connecting the power plug and turning on the equipment with the power button, it takes about 30 seconds to complete booting, so please wait for a while.
12. Do not power on the device within 10 seconds after shutting off the power and entering manual standby mode. Doing so may cause noise.
13. When the power is first connected, the device enters manual standby mode, and in this mode, you have to press the power button to boot it up and use it normally. If you press the power button briefly during use, the device enters active standby mode, and it's only in this mode that you can turn on the power with the Bluetooth remote control or the ROSE Connect application.
14. Install the product close to an outlet so that it is easy to remove the plug from the outlet.
15. It is recommended to use a certified HDMI cable. Otherwise, a connection error may occur, causing problems with the audio and output screens. In addition, when using a long HDMI cable, please be sure to use an HDMI repeater(Signal Amplifier) device to connect it.
16. Do not use the product near water. Do not expose the product to a dripping or splashing environment and do not place objects containing liquids, such as vases, on the device.
17. Do not block the ventilation openings. Install this product according to the product installation and orientation instructions.
18. Unplug the product during lightning storms or when unused for long periods of time.

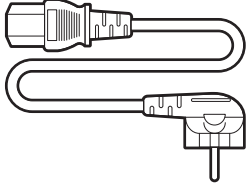
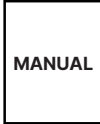
Components List

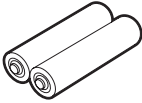
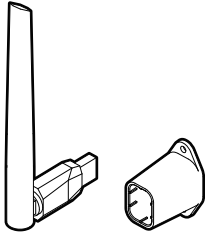
1	Main Device	 A rectangular, slim electronic device with a large central display area and a small 'TOPE' logo at the bottom center. It has two small feet at the bottom.
2	Remote Control	 A slim, rectangular remote control with a 'TOPE' logo on the left side and a series of buttons on the right side.
3	Power Cable, 1.8m	 A power cable with a standard three-prong AC power plug on one end and a USB-A connector on the other. The cable is coiled.
4	User Manual	 A rectangular icon representing a user manual with the word 'MANUAL' printed in the center.
5	SSD Mounting Screws	 Four small screws with Phillips heads, used for mounting an SSD.
6	AAA Batteries for Remote Control	 Two AAA batteries shown side-by-side.
7	USB WiFi Dongle & Dongle Holder	 A USB WiFi dongle with a long antenna and its corresponding plastic protective holder.

Location / Function of Buttons and Ports

1. Front Side of the Product



<p>Power</p>	<p>When you press the power button, the LCD panel will turn on and the product will boot.</p> <p>* For detailed functions, please refer to "Initial Setup" - "Power Button" (p. 40)</p>
<p>Play / Pause</p>	<p>You can adjust the volume level by pressing the volume +/- buttons or dragging the knob up/down on the volume control screen. Volume can be adjusted from 0 to 99 in 100 steps.</p> <p>⚠ Caution : Please note that listening to music at high volume for a long time may cause hearing damage.</p>
<p>Mute</p>	<p>You can enable / disable sound by pressing the Mute button.</p>
<p>Touch Panel</p>	<p>You can multi-touch to move the screen and perform each function.</p>

2. Rear Side of the Product

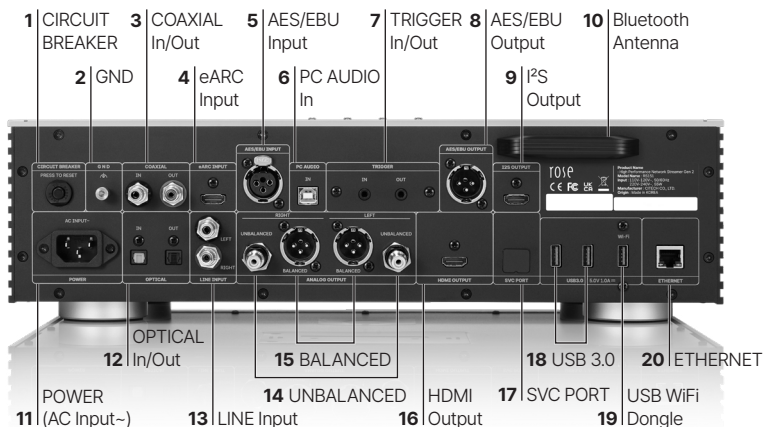

1	CIRCUIT BREAKER	This protection terminal prevents damage to the set due to overvoltage or overcurrent.
2	GND	This port is used to ground the product and external devices.
3	COAXIAL In/Out	Connect the COAXIAL cable to this port to input and output digital signals
4	eARC Input	Connect the HDMI cable to this port and the ARC output port of the external device.
5	AES/EBU Input	Connect the AES/EBU cable to this port to input the digital signals.
6	PC AUDIO Input	Connect the USB Type-B cable to this port and the computer for using this product as the USB DAC of the computer.
7	TRIGGER In/Out	This is a function that automatically turns on the set without operation through the remote control when power is supplied from an external device. When you press the power on button on the set, a power control signal is output to the trigger out terminal after the power is stabilized.
8	AES/EBU Output	Connect the XLR cable. Digital signals are output when AES/EBU mode is set in Input/Output Settings.
9	I²S Output	Connect the HDMI cable to the I ² S port. Digital signals are output when I ² S (A or B mode) is set in Input/Output Settings.
10	Bluetooth Antenna	This is in charge of the Bluetooth function.
11	POWER (AC Input~)	Connect the AC power cable here.
12	OPTICAL In/Out	Connect the OPTICAL cable to this port to input and output digital signals.
13	LINE Input	Connect the RCA cable to this port to input analog signals.
14	UNBALANCED Output	Connect the RCA cable to this port to output analog signals.
15	BALANCED Output	This is a port that receives a balanced input (XLR) from an external source device, and connect the Balanced cable to this port to output analog signals.
16	HDMI Output	Connect a cable that supports HDMI. The video output signal can be played on your TV or monitor.
17	SVC PORT	This port is used for system updates. (A/S Service Only)
18	USB 3.0 (5V 1.0A=)	You can play music files by connecting a USB flash drive or using the ripping function by connecting a CD ROM.
19	USB WiFi Dongle (5V 1.0A=)	Connect the USB Dongle to this USB port for WiFi.
20	ETHERNET	10/100/1000 BASE-T Ethernet can be used by connecting the LAN cable to this port.

3. Remote Control

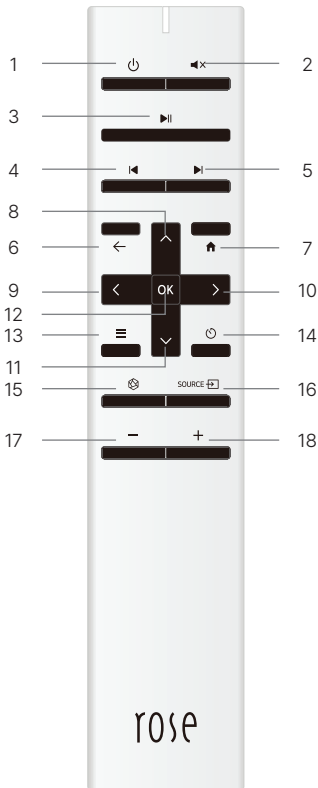

1	Power On/Off	Used to power the set on or off.
2	Mute	Used to mute music.
3	Play / Pause Current Song	
4	Play Previous Song	
5	Play Next song	
6	Go Back	
7	Go to the Home Screen	
8	Move Focus Up	
9	Move Focus Left	
10	Move Focus Right	
11	Move Focus Down	
12	Select Current Focus	
13	Queue Settings	Enter Queue Settings(:) located to the right of the list of songs and videos.
14	Sleep Timer	
15	Go to Favorites Menu	Go to the favorites menu set on this device
16	Go to External Input/Output Menu	Go to Input/Output page
17	Volume Down	Press and hold to adjust the volume down
18	Volume Up	Press and hold to adjust the volume up

※ This remote control uses infrared (IR) and may malfunction if supplied power decreases. In this case, replace the battery before use.

Product Installation

1. Product Design Method and Recommended Installation Location

- This product is designed to be used on a table or shelf.
- This product can malfunction during cold weather or hot weather.
(Operating temperature: 0 to 40°C, Storage temperature: -10 to 50°C)
- If the space where the product is installed is small, provide adequate ventilation for the product. A longer operating life is ensured when electronics are properly ventilated and maintained so that they do not overheat more than necessary. Do not install this product directly on a device that generates a lot of heat, such as a power amplifier.
- The figure below shows the minimum ventilation requirements required for the product.
- Keep at least 2.5cm apart on each side of this product to prevent airflow from clogging.
- Secure a depth of 40cm for airflow and cabling.

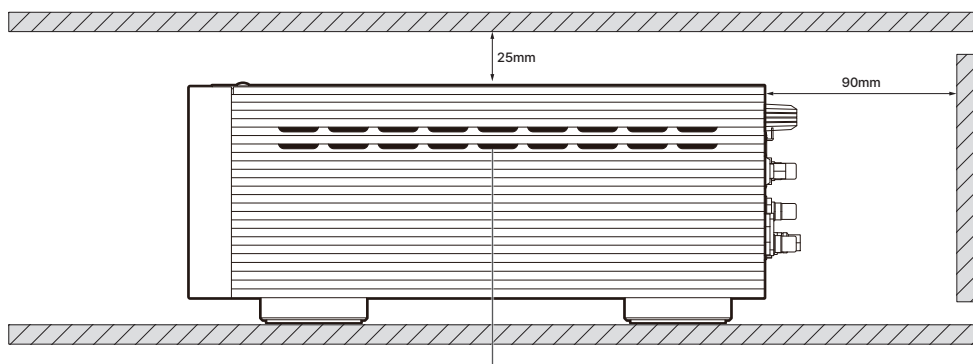
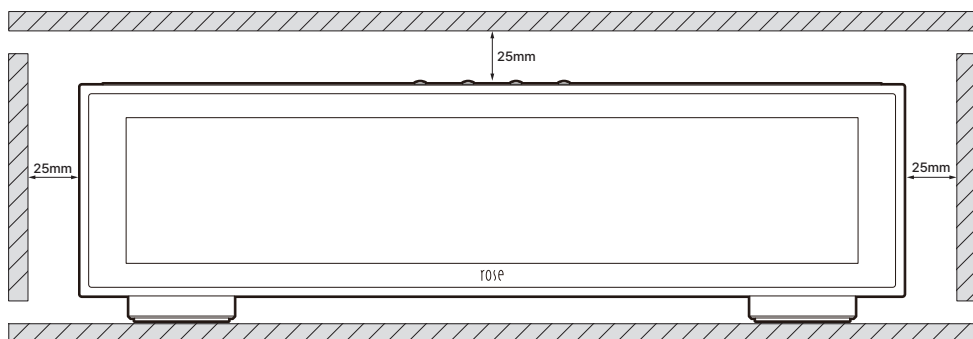

Ventilation Openings
(Located on both sides of the product)

2. How to Connect the Power Cord

- This product includes a removable power cord. Please connect the power cord after connecting all audio cables.

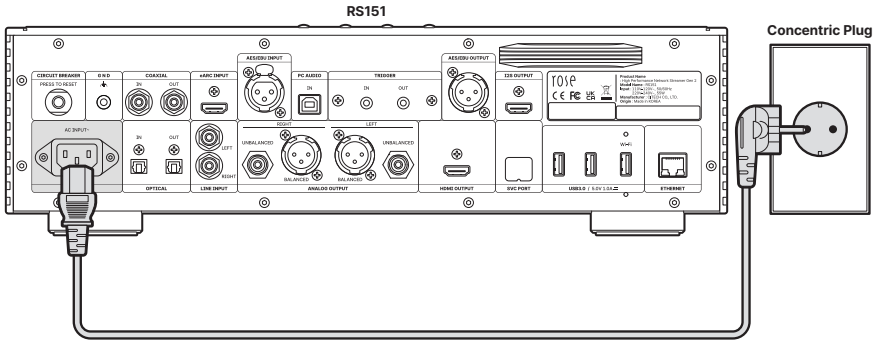

- ⚠ **Caution:** When disconnecting the power cord, always disconnect the power outlet first with the power switch off.

3. How to Properly Connect Rear Ports and Cables

3-1. Connection Between Analog Output Port and Power Amplifier or AV Receiver

- You can connect the analog (BALANCED/UNBALANCED) audio output of this product to the analog input port of the power amplifier or AV receiver as shown in the figure below.
- The analog audio output volume adjustment for this product can be selected as “Variable” and “Fixed” through the pre-out level settings.

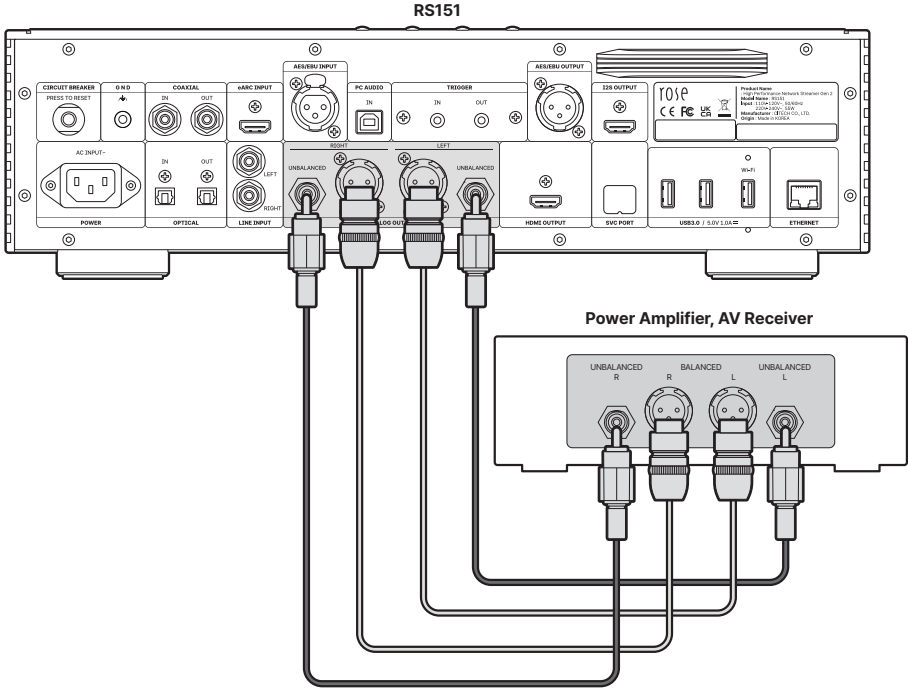

⚠ Caution: Before connecting this product to the power amplifier, set the volume of the product to mute or below level 5, and then connect it using an interconnector. If you connect the cable while the product is playing music at a high volume, a loud shock sound may occur.

3-2. Connection Between Analog Input Port and Audio Device

- You can connect the analog output port of an external device such as a CD player to the analog audio input port (LINE IN) of this product as shown in the figure below.
- When using analog audio input as a source, you need to switch the input source to "LINE IN" in the In/Out Setting. You can change the In/Out Setting from the home screen, settings, settings on the ROSE Connect Premium App, and the remote control.

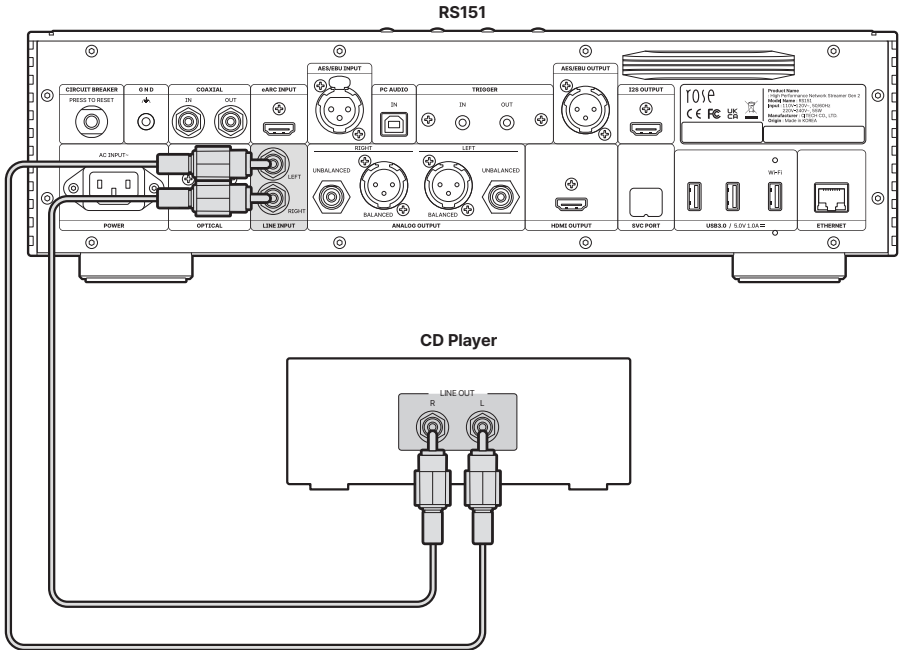

3-3. Connection Between Analog Input/Output Port and Audio Device (TV or Devices That Provide Digital Input / Output Capabilities)

3-3-1. OPTICAL/COAXIAL

- You can connect the digital input/output port of an external device to the digital (OPTICAL/COAXIAL) input/output port of this product as shown in the figure below.
- This product can reproduce linear PCM signals with sampling frequencies of 44.1kHz, 48kHz, 88.2kHz, 96kHz, 176.4kHz, 192kHz and 384kHz. (However, OPTICAL is supported up to 192kHz)
- When using analog audio input as a source, you need to switch the input source to 'OPTICAL In, COAXIAL In, AES/EBU In, I²S In' in the In/Out Setting.
- To export digital output, you must activate the output mode as 'OPTICAL Out, COAXIAL Out, AES/EBU Out, I²S OUT' in the In/Out Setting.
- You can change the In/Out Setting from the home screen, settings, settings in the ROSE Connect Premium App, and the remote control.

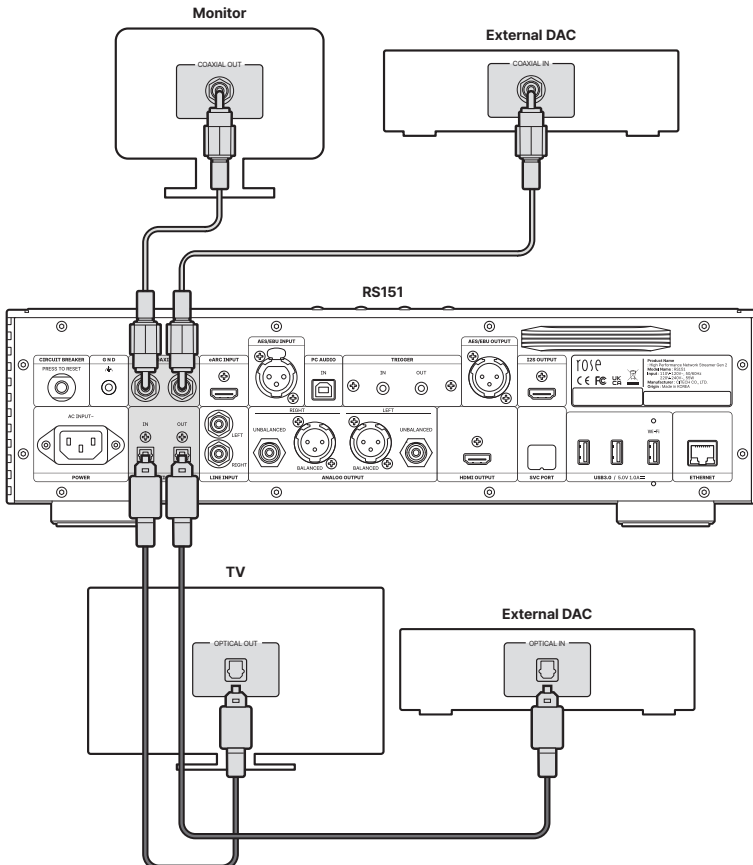

⚠ Caution: Do not input signals other than linear PCM signals such as Dolby Digital, DTS, and AAC to this device. It may cause noise and damage to the speakers.

3-3-2. AES/EBU

- You can connect the digital input/output port of an external device to the digital (AES/EBU) input/output port of this product as shown in the figure below.
- You can connect an external CD player or other source device to the AES/EBU IN port of this product.
- Also, you can use an external DAC by connecting it to the AES/EBU OUT port of this product.

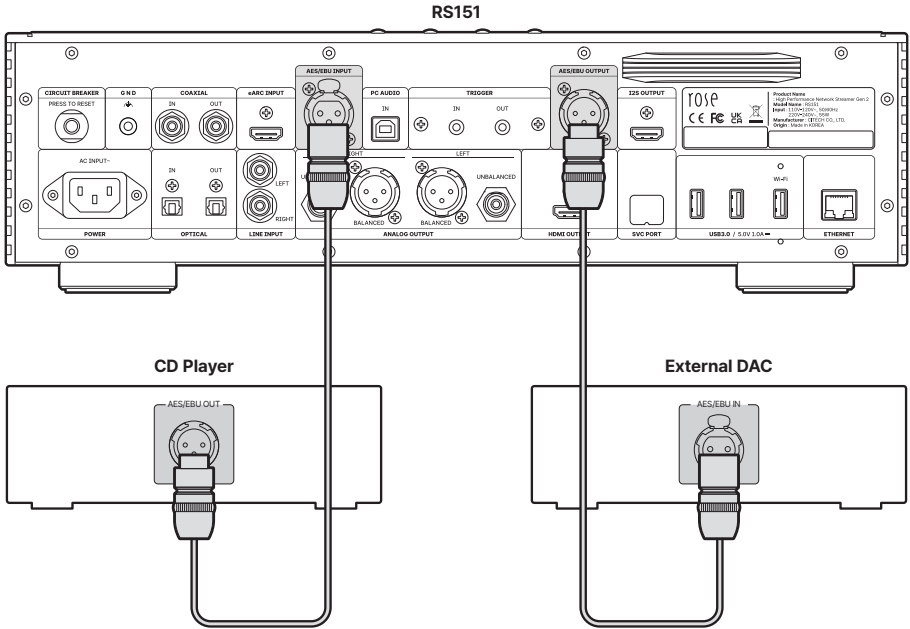

3-3-3. eARC IN

- You can connect the TV to the eARC IN (HDMI) port of this product as shown in the figure below.
- If you connect this product to the HDMI port of a TV that provides an ARC connection with an HDMI cable, you can receive audio signals from the TV from the product and listen to music through speakers connected to an external amplifier device.

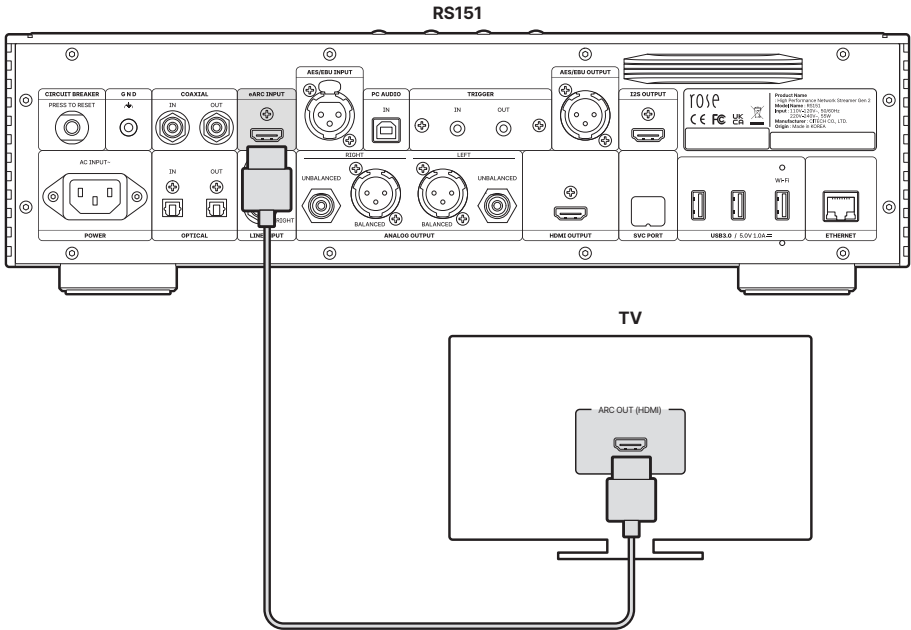

3-3-4. I²S OUT

• You can connect the input port of an external DAC to the I²S OUT(HDMI) port of this product as shown in the figure below.

※ For more information, refer to "In/Out Setting" - "OUTPUT" - "Digital". (p. 43)

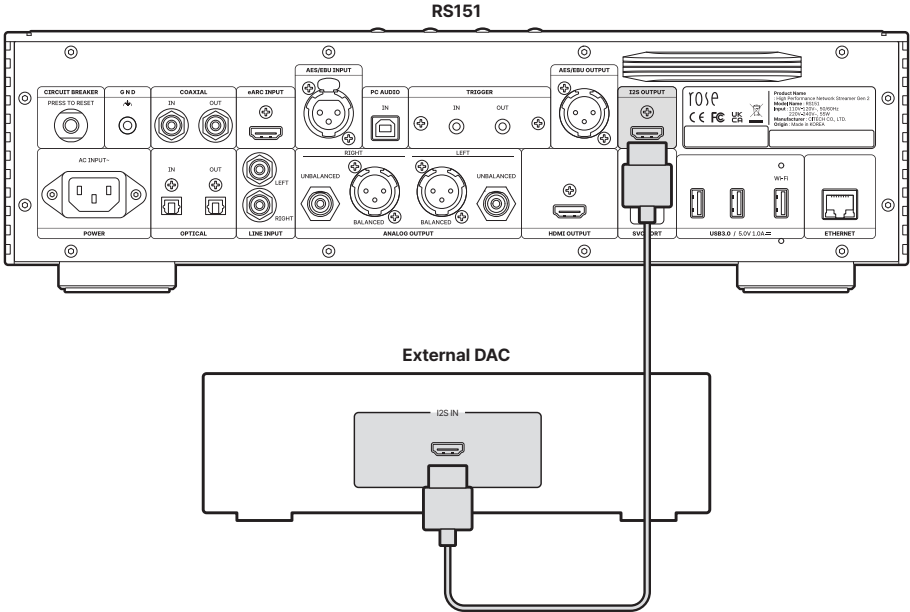

3-4. HDMI Connection

- You can connect the TV to the HDMI port of this product as shown in the figure below.
- Video output signals (up to 3840 × 2160/60Hz) can be played back by connecting this product to a TV.

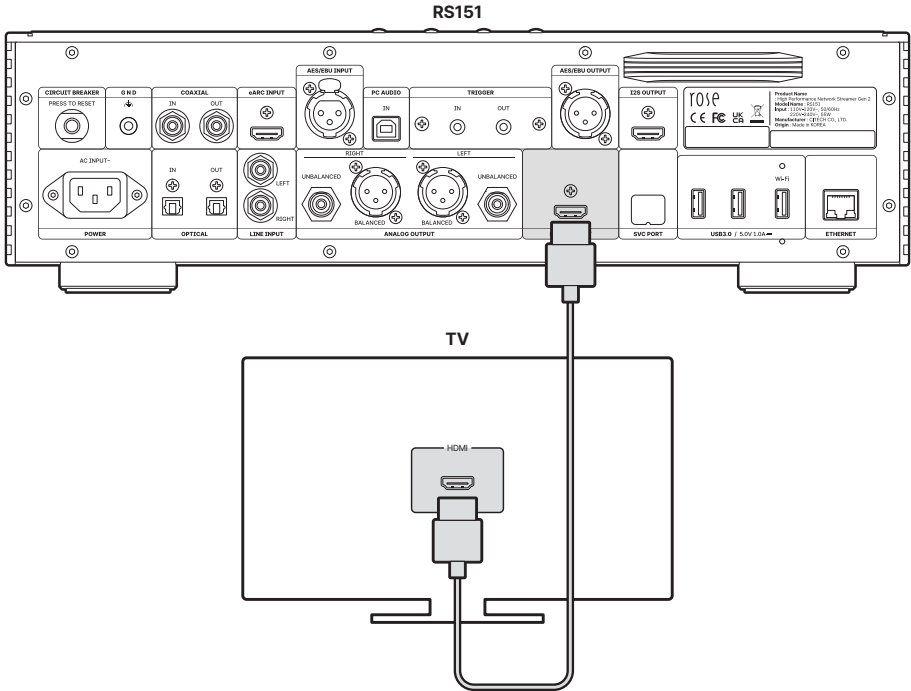

3-5. PC AUDIO Connection

- Connect the device as shown in the figure below.

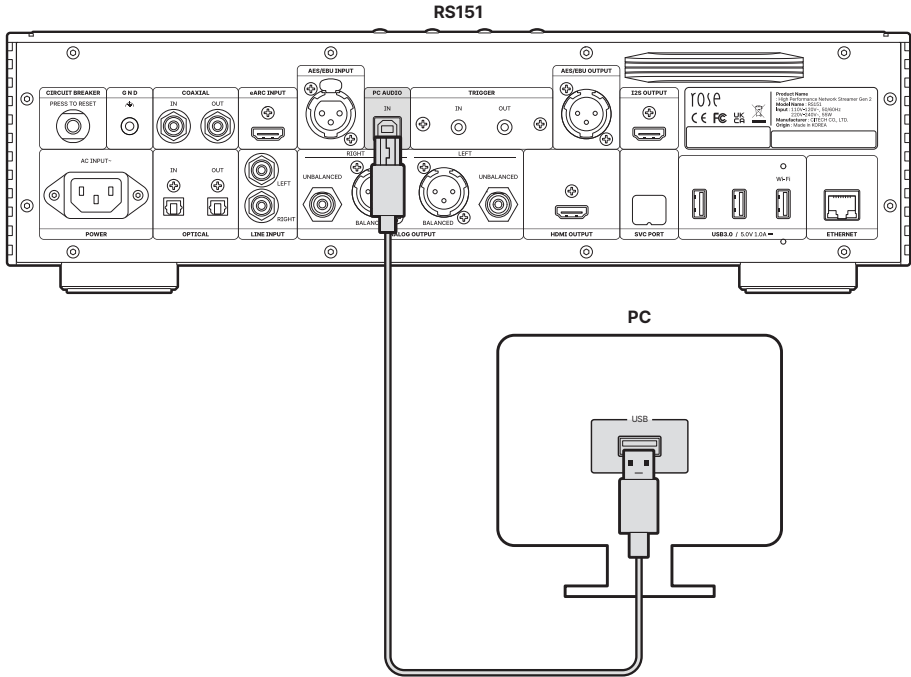

- **3-5-1.** After accessing the ROSE website, download the Rose_UsbAudio_[VERSION].zip file in "Downloads" under "Support". You can access this category by entering the URL in the browser (<https://hifirose.com/download>) or by scanning the QR code on the right.
- **3-5-2.** When you unzip the downloaded Rose_UsbAudio_[VERSION] file and run Rose_UsbAudio_[VERSION].exe, the screen appears as shown in the picture below. Please select Next.

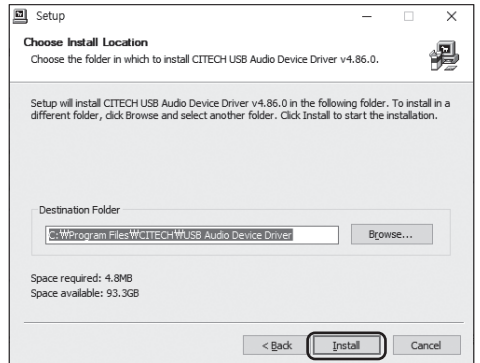
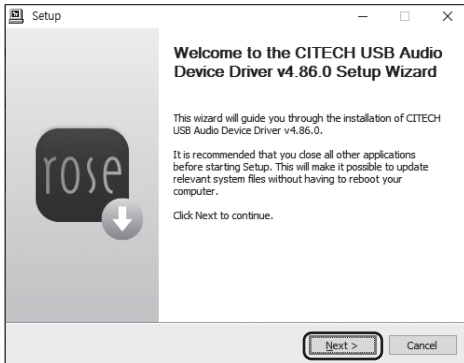

3-6. How to Connect the USB Flash Drive to DAC

- A USB 3.0 / USB 2.0 storage device or USB WiFi Dongle can be connected to the USB port of this product.

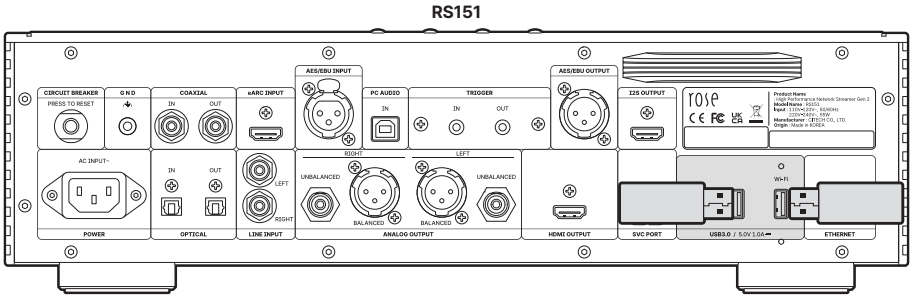

3-7. How to Connect the USB Audio Output Port to External DAC

- Connect the device as shown in the figure below.
 - You can connect an external DAC to the USB port of this product.
 - After connecting an external USB DAC to the USB 2.0 port of this product, you can select USB output in the Input/Output Settings and then select the output with the recognized external USB DAC.
- ※ This product complies with the USB Audio Class 2.0 specifications.

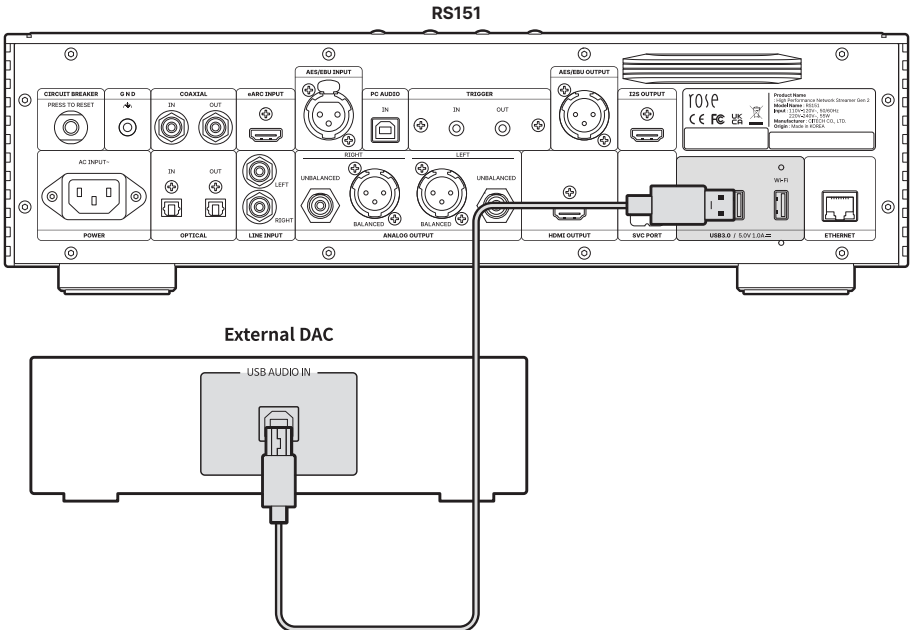

3-8. USB WiFi Connection

- You can connect the USB WiFi Dongle module to the USB WiFi Dongle port of this product as shown in the figure below.
- For stable USB Wi-Fi Dongle use, first remove the fixing screws (2 pcs) on the main body. Next, secure the Dongle holder (❶) using two bolts (❷) and install the USB Wi-Fi Dongle (❸).
- ※ For the WiFi Dongle, it is recommended to use 2.4GHz/5GHz dual-band WiFi.
- ※ For a detailed description of WiFi, refer to “Network Connection” – “WiFi Connection (Wireless)”. (p. 37)

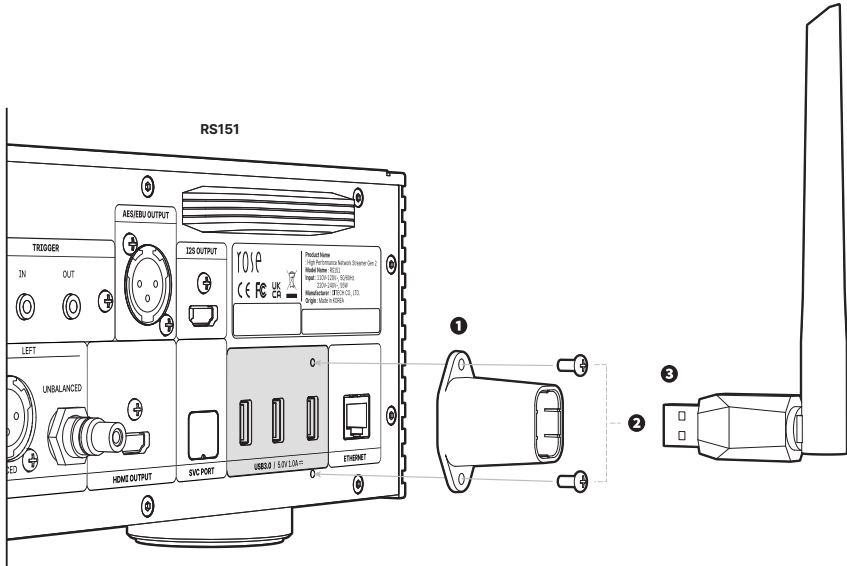

3-9. Circuit Breaker

- This is a circuit breaker terminal to protect the circuit from damage caused by overvoltage or overcurrent.
- Similar to the power circuit breaker in a home, when overvoltage or overcurrent is applied from the outside, the switch terminal protrudes outward to block the power supply. When pressed again by hand, the terminal is inserted inward, connecting the internal circuit to the power supply.
- ※ If the protruding motion is repeated even after you press the switch, there may be a problem with the internal circuit. Please remove the power cord and request product repair.

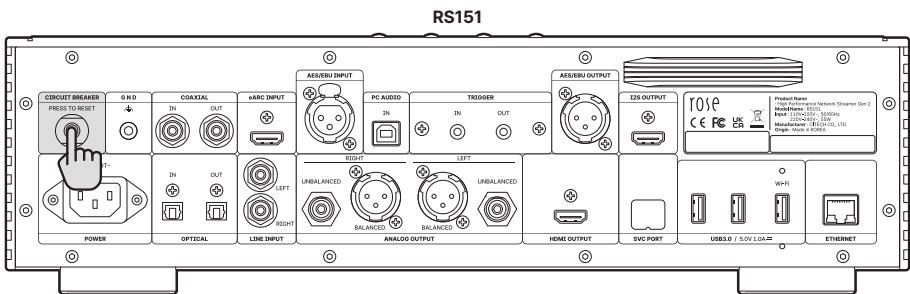

3-10. GND Connection

- You can ground the GND terminal of an external device to the GND terminal of this product as shown in the figure below.
- ※ When a lot of noise is generated, you can reduce the noise by connecting this GND terminal to the signal GND of an external device.
- ※ Reversing the signal GND connection may increase noise and cause unintended errors. In this case, please remove the signal GND connection line between the devices.

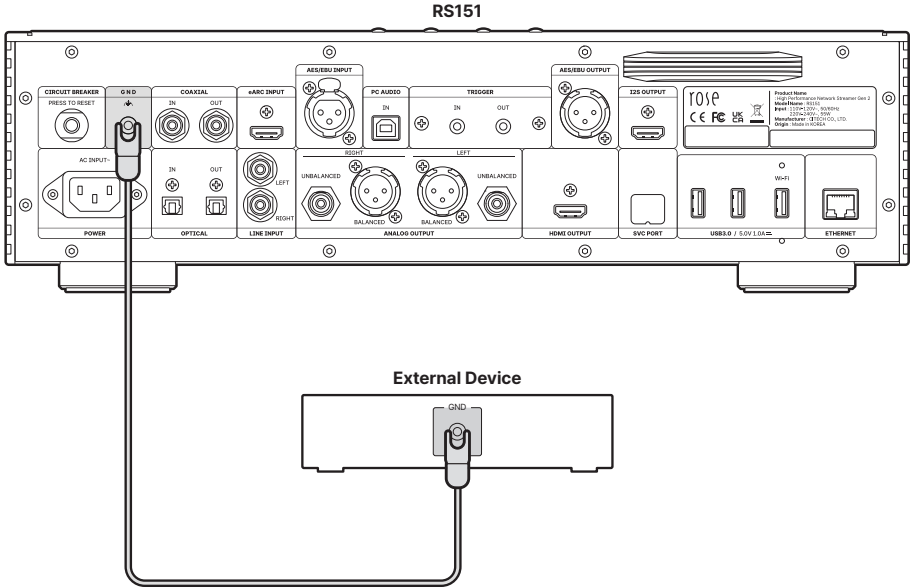

4. External Memory Devices (USB) and SATA Storage Devices

- This product can connect external memory devices and SATA type storage devices.
- When connecting a storage device using SATA, it is recommended to use an SSD.
- USB storage devices are compatible up to 10TB, and SATA storage devices up to 4TB.
- ※ SSD can be purchased separately, and only 7mm thickness can be used.
- ※ It has only been tested on SAMSUNG SSD for compatibility, and may not function normally on some SSD(Intel).

5. How to Connect SSD

5-1. How to Insert SSD

- **5-1-1.** Remove the SSD cover fixing screws (2 pcs) on the bottom of the main body.
- **5-1-2.** Remove the SSD cover by pushing the part marked OPEN.



- **5-1-3.** Install the SSD in line with the port on the SSD cover.
- **5-1-4.** Fix the SSD to the SSD cover with the SSD mounting screws (4 pcs).

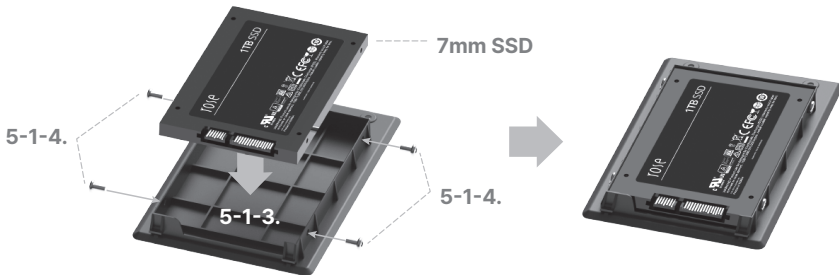

- **5-1-5.** Assemble the SSD cover with the SSD installed on the main body.
- **5-1-6.** Push the part marked LOCK to re-fix the screws.

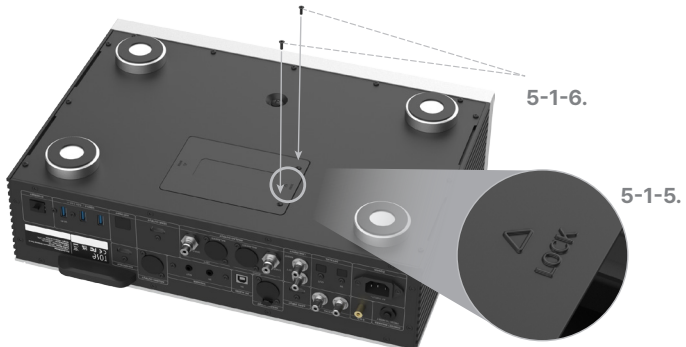

5-2. How to Format After Installing SSD

- You can format the SSD connected to this product from the SSD Format menu in Storage Setting.

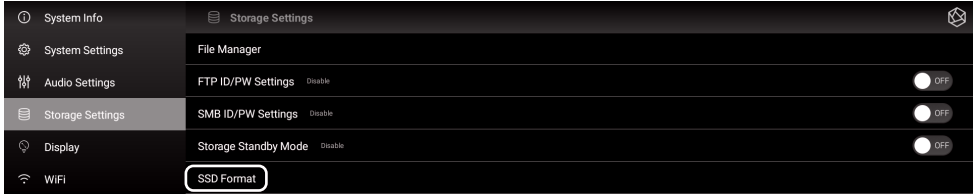

5-3. How to Copy Files Through the Network

- Set SMB ID/PW in Storage Settings.

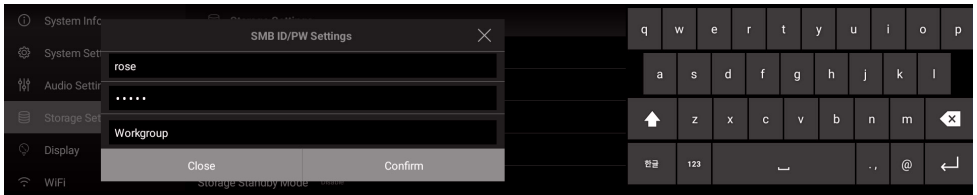

- After entering \\ROSE IP on your PC, enter the ID/PW that you set up in SMB, and the storage connected with this product will appear and you can copy the files directly from your PC.

※ To connect to the SMB of this product from a PC, both devices must be connected to the same network.

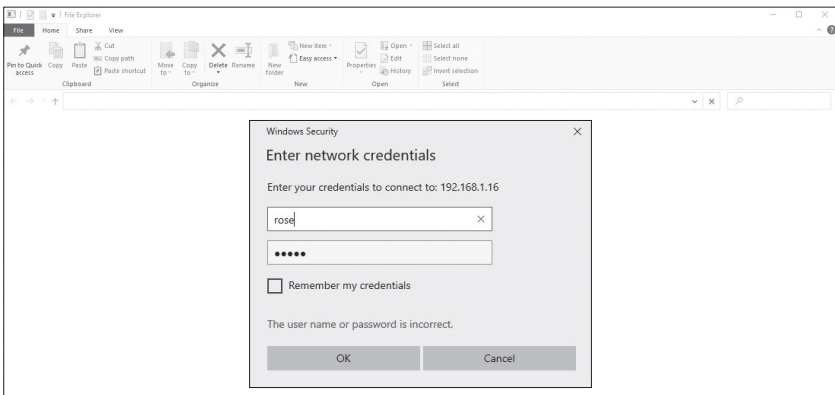
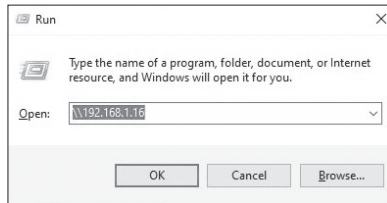

6. Network Connection

• This product can be connected to the network via wired/wireless connection.

6-1. Ethernet Connection (Wired)

- After you connect a LAN to the rear Ethernet port, select ON from the Settings - Ethernet menu to connect to the network.
- When connected normally, the IP address and other information are automatically received.

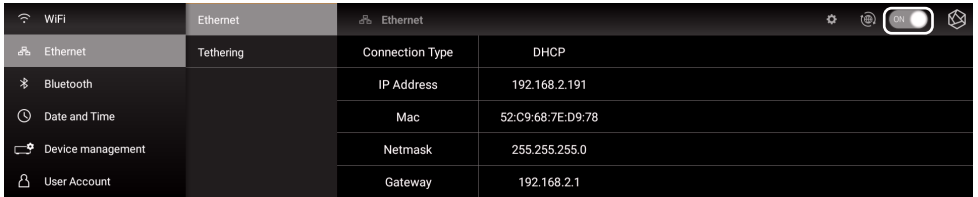

- **6-1-1.** After Ethernet connection, you can use this product as a WiFi hotspot. After entering the network name and password, you can enable the hotspot function, and other devices can use the password to connect to this WiFi hotspot.



6-2. WiFi Connection (Wireless)

- When you turn on WiFi from the Settings - WiFi menu, a list of currently accessible SSIDs appears, and you can select the desired SSID to connect to the network.
- If Wi-Fi is connected normally, IP address and other information will be automatically obtained.

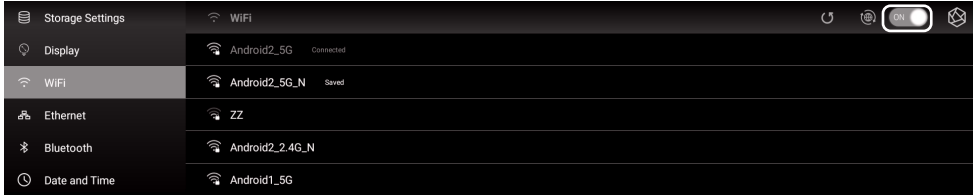

- ※ You can remotely control this product by downloading and installing the ROSE Connect Premium App supported through the Google Play Store and App Store on your smartphone.

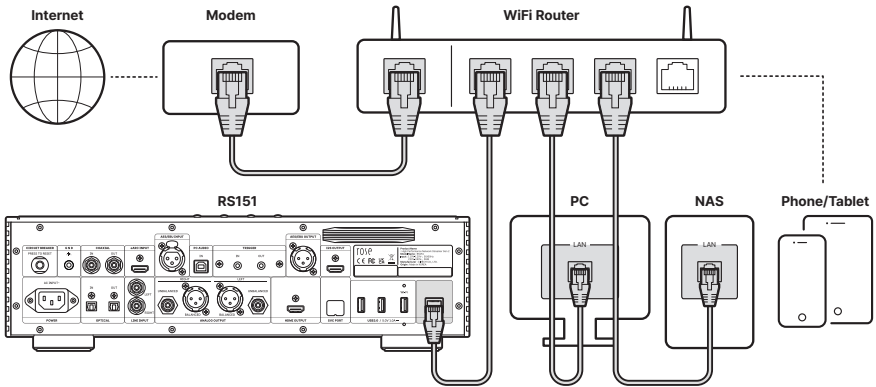

- ※ To control this product on your smartphone (ROSE Connect Premium), it must be connected to the same network. (You can configure a single network using wireless network extenders, bridges, etc.)

7. How to Connect to RoonReady

- Before using RoonReady, first access the Roon homepage and create an account. Download RoonCore and install the software on your PC. You can access it by entering the URL into the browser (<https://roon.app/en/>) or by scanning the QR code on the right.
- Various music managed by RoonCore will appear.



The screenshot shows the Roon music player interface. At the top, it says "Hi, MJ". Below this are four statistics: 755 ARTISTS, 1113 ALBUMS, 9973 TRACKS, and 195 COMPOSERS. The main section is titled "Recent activity" and "ADDED". It displays five music items:

- Slanted & Enchanted Pavement**: Added 7 days ago. Album cover features the text "PAVEMENT SLANTED AND ENCHANTED".
- The Look Of Love Diana Krall**: Added 12 days ago. Album cover shows a woman sitting on a chair.
- Nameless Dominique Fils-Aimé**: Added 12 days ago. Album cover shows a profile of a man's head.
- Arvo Pärt: Miserere (Live) Howard Arman / Chor des Bay**: Added 18 days ago. Album cover features a portrait of Arvo Pärt.
- Anton Bruckner & Michael Haydn Motets MDR Leipzig Radio Choir/Philip**: Added 18 days ago. Album cover shows a church interior.

At the bottom, there is a playback control bar with "Nothing playing" on the left and "System Output 100" on the right.

- Select this product from “Select Audio” in Settings - Audio.

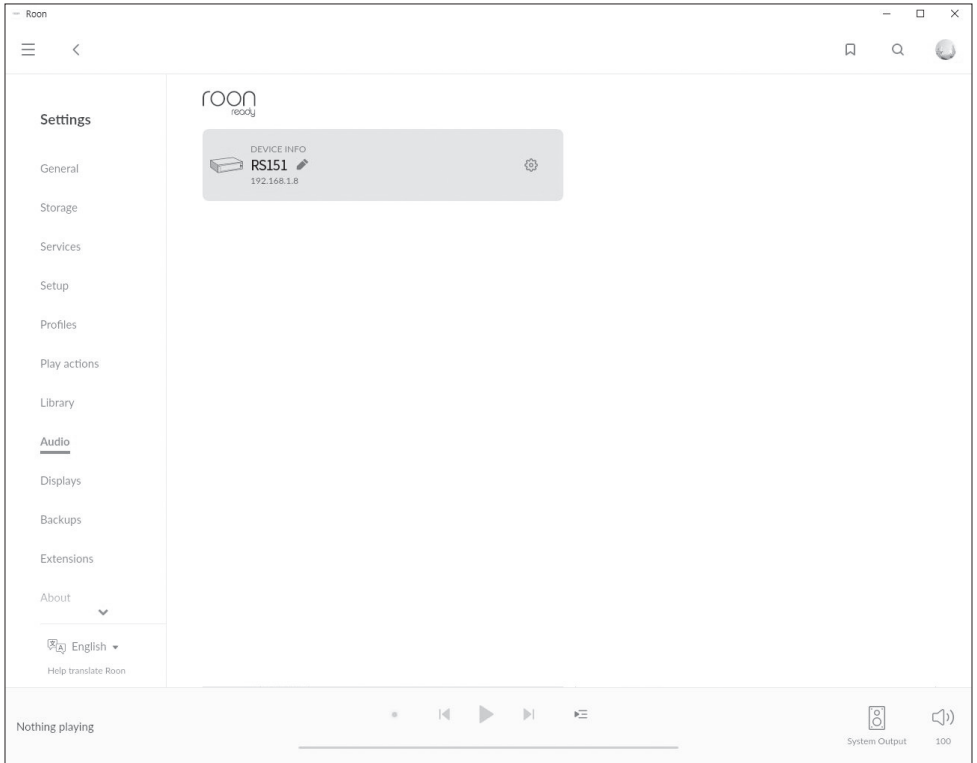

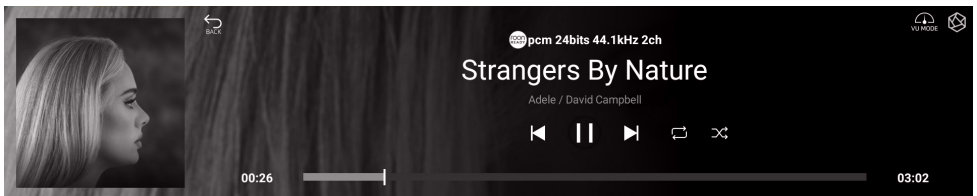

- Once the connection with ROSE is complete, you can play and listen to music on the RoonReady.



- ※ To control this product from RoonReady, both the product and RoonReady must be connected to the same network.

Default Settings

1. Power Button

- **1-1.** You can turn this product on and off by pressing the power button briefly.
 - 1-1-1.** If you press the power button briefly, the product will enter the standby mode when the power is on, and the product will be turned on when the power is off.
 - 1-1-2.** If you press the power button during booting, the product will turn off.
 - **1-2.** Press the power button for 3 seconds to display the [LCD OFF | Power OFF | Reboot] menu.
 - 1-2-1.** LCD OFF () : Music is played and only the screen is turned off. If you press the power button again while the LCD is off, the screen will be turned on.
 - ※ This function can only turn off the screen while using the product.
 - 1-2-2.** Power OFF () : The power will be turned off.
 - 1-2-3.** Reboot () : The product will be turned off and on and then display the home screen.
- ※ If you touch a screen other than the menu, it will be canceled.
- **1-3.** Power button LED status : Screen on (LED OFF) / Screen off (LED ON)
 - **1-4.** Press and hold the power button for more than 5 seconds to force a reboot.

2. In/Out Setting

- Select the "In/Out Setting" icon on the main screen to move to the In/Out Setting menu.

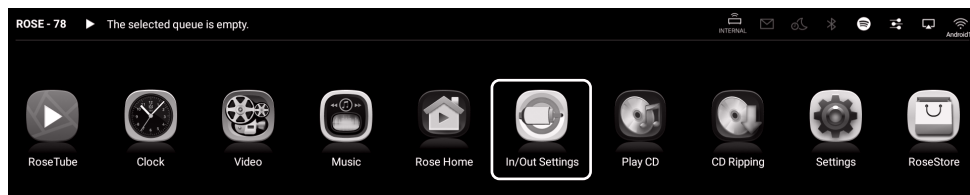

2-1. INPUT

- You can select an input by selecting the icon from the INPUT Settings menu.
When activated, the icon changes to gold color and a check mark appears.

※ Only one input can be selected at a time.

2-1-1. RS151

- This is the default mode at first start-up; select it when playing music or streaming sources from a storage device.
- If external input is in use, it is automatically selected if you play the music or streaming on the storage device.

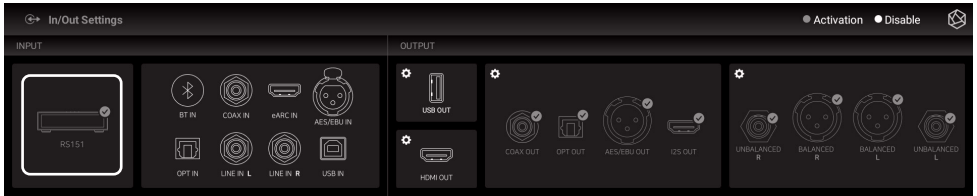

2-1-2. BT IN

- When using Bluetooth Input as a source, select the input source as "BT IN" in the In/Out Setting.

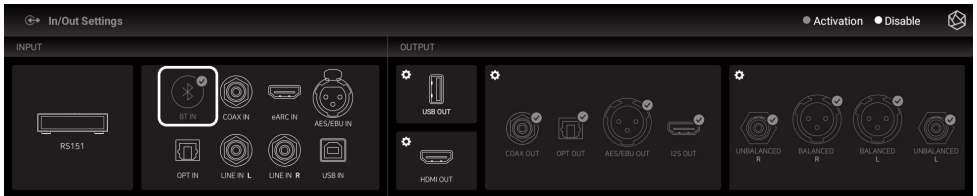

2-1-3. COAX IN

- When using Coaxial Input as a source, select the input source as "COAX IN" in the In/Out Setting.

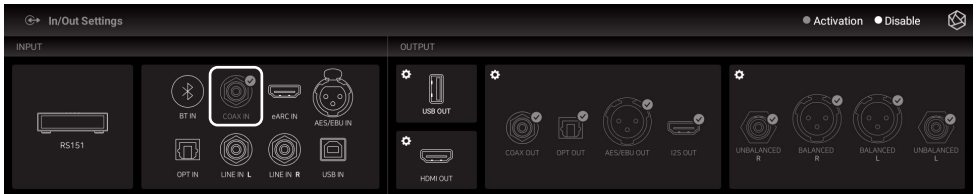

2-1-4. eARC IN

- When using eARC Input as a source, select the input source as “eARC IN” in the In/Out Setting.



2-1-5. AES/EBU IN

- When using AES/EBU Input as a source, select the input source as “AES/EBU IN” in In/Out Setting.

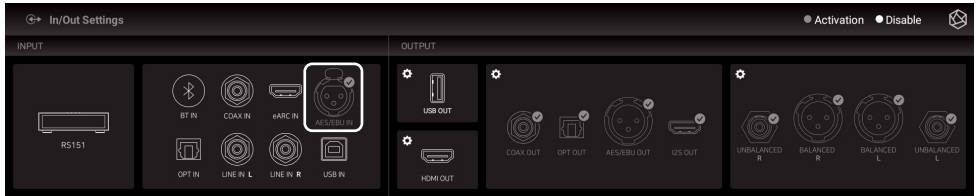

2-1-6. OPT IN

- When using Optical Input as a source, select the input source as “OPT IN” in the In/Out Setting.

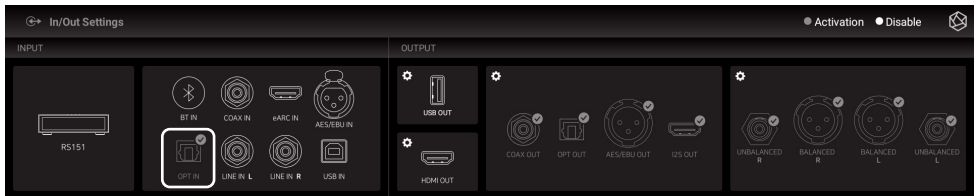

2-1-7. LINE IN

- When using LINE Input as a source, select the input source as "LINE IN" in the In/Out Setting.



2-1-8. USB IN

- When connecting this product to a PC and using it as a USB DAC, select the source as USB IN in the In/Out Setting.

※ Please refer to "Product Installation" – "USB IN Connection". (p. 29)

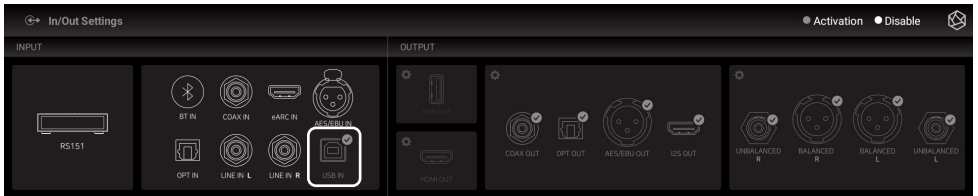

2-2. OUTPUT

- You can enable/disable output settings by selecting the icon in the Output Settings menu.
- When activated, the icon changes to gold color and a check mark appears.
- Only one of USB, HDMI, and Internal DAC can be selected.
- For Internal DAC, you can enable multiple output ports.

2-2-1. USB DAC

- When you connect a USB DAC and select USB, a list of connected USB DACs appears. Select the USB DAC you want to use from the list.



- If you select USB DAC, the model name of the selected USB DAC appears and becomes available.



- If you select the setting icon for USB DAC, you will see the USB DAC Setting screen below.

2-2-1-1. MQA Type

- This is the menu to set the MQA playback mode. You can select Authenticator or Decoder mode. Only original sound or decoded audio data can be exported to digital output; full-decoded audio data cannot be exported.

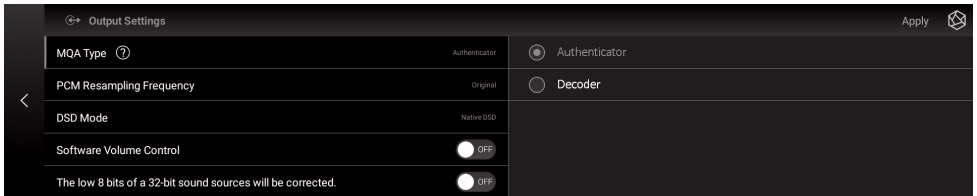

2-2-1-2. PCM Resampling Frequency

- Max Sample Rate: You can set the maximum number of samples for the connected DAC.
- Resample Rate: If you want to output at the same sampling rate as the original sound, select Original Sampling Rate. To use the resampling feature, select the desired Resample Rate.

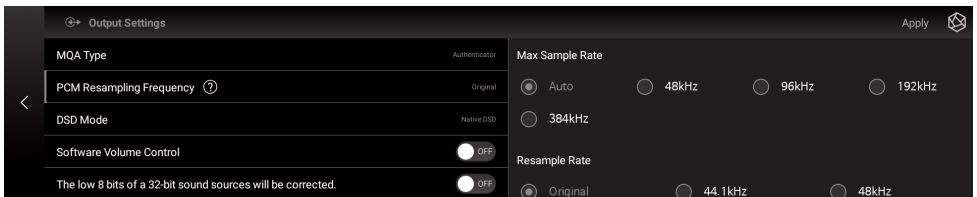

2-2-1-3. DSD Mode

- When connecting an external USB DAC, up to DSD512 is supported if the DAC supports native DSD, and up to DSD256 is supported if the DAC supports DoP mode.

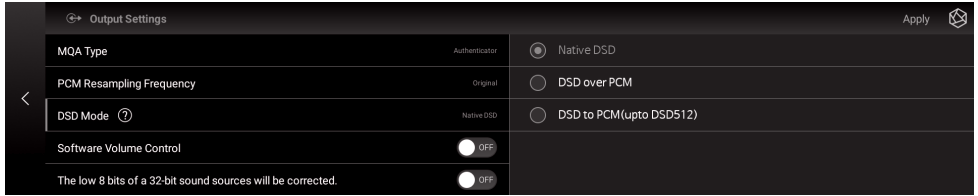

2-2-1-4. Software Volume Control

- You can adjust the playback volume of digital audio data using the ROSE Volume Control software.

⚠ Caution 1 : Not available in Native DSD and DSD over PCM modes. Can be applied after changing to DSD to PCM (up to DSD512) mode.

⚠ Caution 2 : For digital output, MQA stream is supported only when the volume is at maximum. MQA stream is not supported when the volume is less than the maximum.

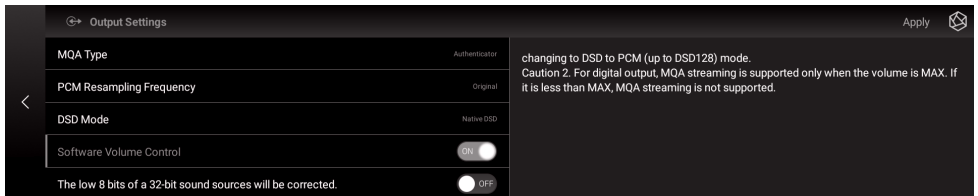

2-2-1-5. The low 8 bits of a 32-bit sound sources will be corrected

- Some DACs may produce noise when playing 32-bit audio at high sampling rates. In this case, this function can be used to reduce noise by correcting the lower 8 bits.

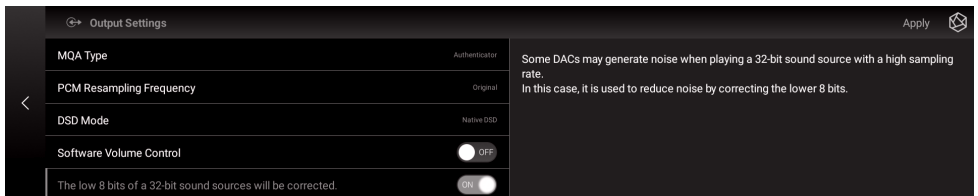

2-2-2. HDMI

- You can set up HDMI.



- When you select the setting icon for the HDMI, the HDMI Setting screen appears as shown below.

2-2-2-1. PCM Resampling Frequency

- Max Sample Rate: You can set the maximum number of samples for the connected DAC.
- Resample Rate: If you want to output at the same sampling rate as the original sound, select Original Sampling Rate. To use the resampling feature, select the desired Resample Rate.

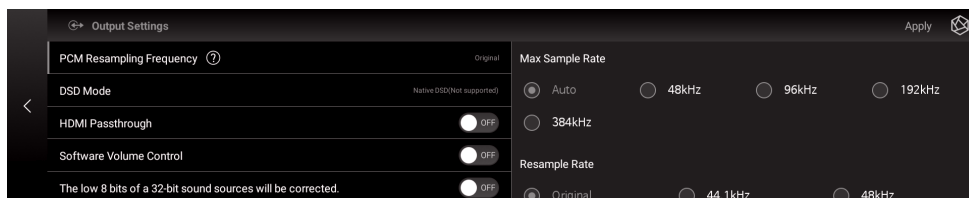

2-2-2-2. DSD Mode

- For HDMI output, only DSD to PCM is possible.

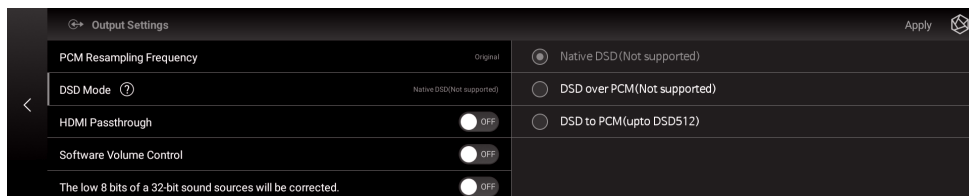

2-2-2-3. HDMI Passthrough

- When you activate it, HD audio formats such as surround music files bypass audio receiver via HDMI without decoding.

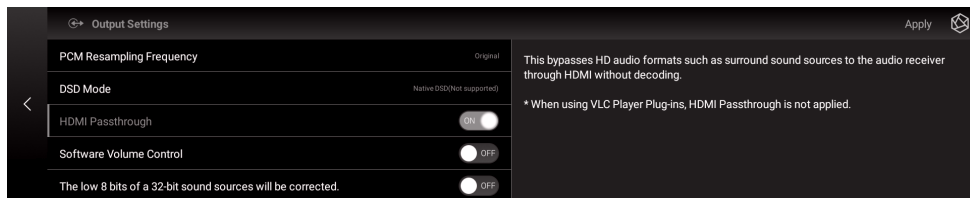

2-2-2-4. Software Volume Control

- You can adjust the playback volume of digital audio data using the ROSE Volume Control software.

⚠ **Caution 1** : Not available in Native DSD and DSD over PCM modes. Can be applied after changing to DSD to PCM (up to DSD512) mode.

⚠ **Caution 2** : For digital output, MQA stream is supported only when the volume is at maximum. MQA stream is not supported when the volume is less than the maximum.

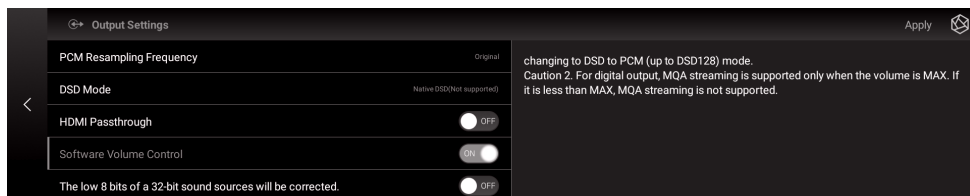

2-2-2-5. The low 8 bits of a 32-bit sound sources will be corrected

- Some DACs may produce noise when playing 32-bit audio at high sampling rates. In this case, this function can be used to reduce noise by correcting the lower 8 bits.

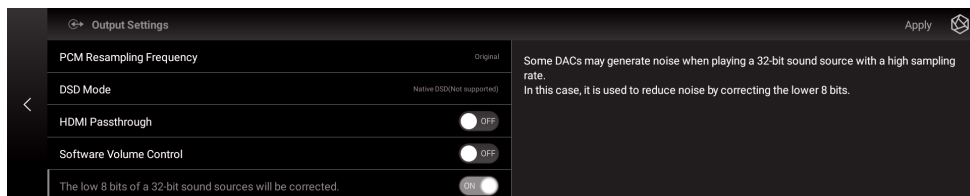

2-2-3. Digital

- You can set AES/EBU OUT, I²S OUT(HDMI), OPT OUT and COAX OUT.

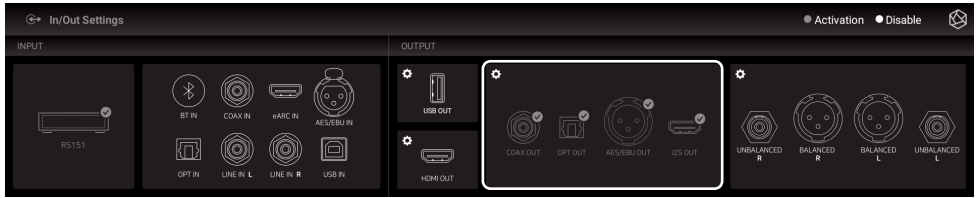

- If you select the Digital setting icon, the Digital output setting screen appears as follows.

2-2-3-1. MQA Type

- This is the menu to set the MQA playback mode. You can select Authenticator or Decoder mode. Only original sound or decoded audio data can be exported to digital output; full-decoded audio data cannot be exported.

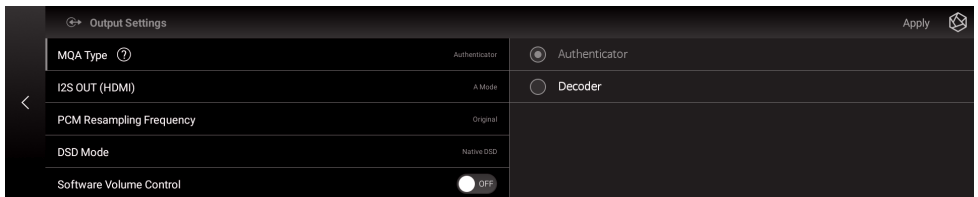

2-2-3-2. I²S OUT(HDMI)

- This is the menu to set the I²S signal output. Select the appropriate mode for the I²S output port you are using by referring to the pin layout of A and B mode.

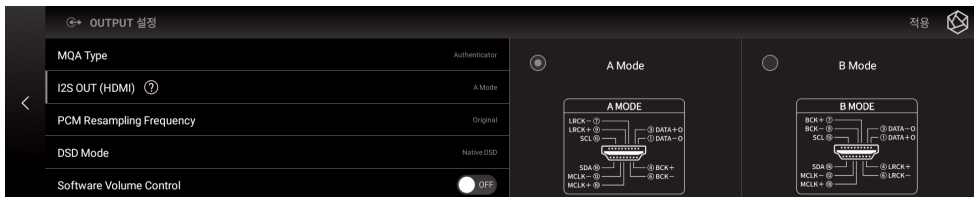

2-2-3-3. PCM Resampling Frequency

- Max Sample Rate: You can set the maximum number of samples for the connected DAC.
- Resample Rate: If you want to output at the same sampling rate as the original sound, select Original Sampling Rate. To use the resampling feature, select the desired Resample Rate.

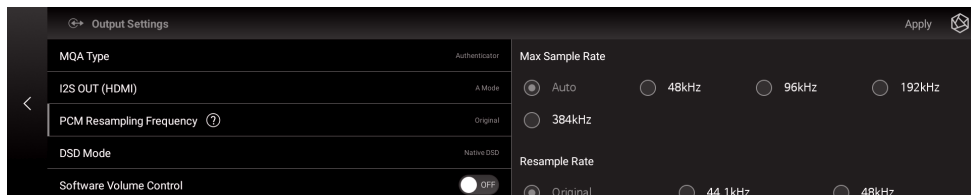

2-2-3-4. DSD Mode

- For digital output, some restrictions on the supported method and sampling rate may apply depending on the output port.
- For OPT output, up to DSD64 is supported in DoP mode. (Native DSD mode is not supported.)
- For AES/EBU and coaxial output, up to DSD128 is supported in DoP mode. (Native DSD mode is not supported.)
- For I²S output, up to DSD512 is supported in native DSD mode and up to DSD256 is supported in DoP mode.

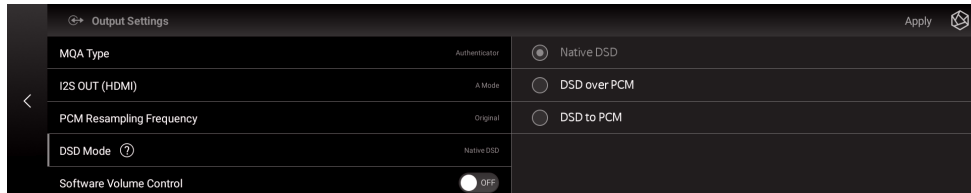

2-2-3-5. Software Volume Control

- You can adjust the playback volume of digital audio data using the ROSE Volume Control software.

⚠ **Caution 1** : Not available in Native DSD and DSD over PCM modes. Can be applied after changing to DSD to PCM (up to DSD512) mode.

⚠ **Caution 2** : For digital output, MQA stream is supported only when the volume is at maximum. MQA stream is not supported when the volume is less than the maximum.

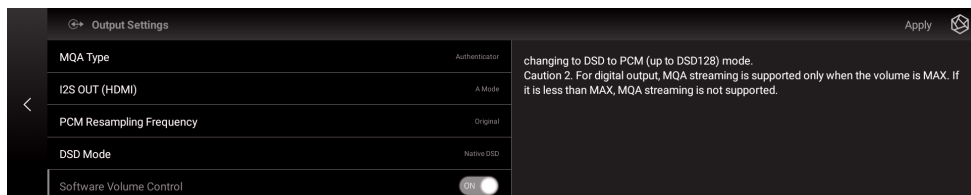

2-2-3-6. The low 8 bits of a 32-bit sound sources will be corrected

- Some DACs may produce noise when playing 32-bit audio at high sampling rates. In this case, this function can be used to reduce noise by correcting the lower 8 bits.

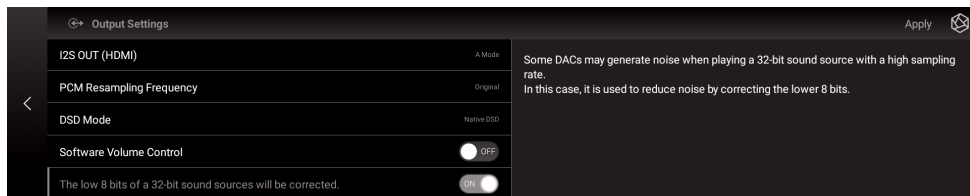

2-2-4. Analog

- You can set the Analog Out(UNBALANCED R/L, BALANCED R/L).

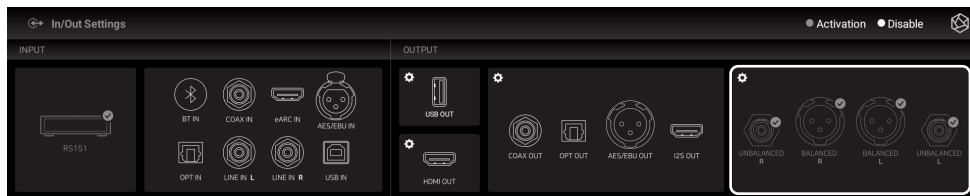

- If you select the Analog setting icon, the Analog output setting screen appears as follows.

2-2-4-1. Pre-Out Level Settings

- This is the menu to fix the pre-output level. The output level of this product can be fixed with the input value within the allowable range of the connected AMP without using the volume control of this product.

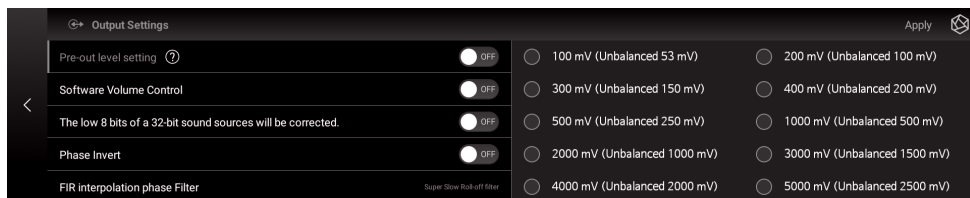

2-2-4-2. Software Volume Control

- You can adjust the playback volume of digital audio data using the ROSE Volume Control software.

⚠ Caution 1 : Not available in Native DSD and DSD over PCM modes. Can be applied after changing to DSD to PCM (up to DSD512) mode.

⚠ Caution 2 : For digital output, MQA stream is supported only when the volume is at maximum. MQA stream is not supported when the volume is less than the maximum.

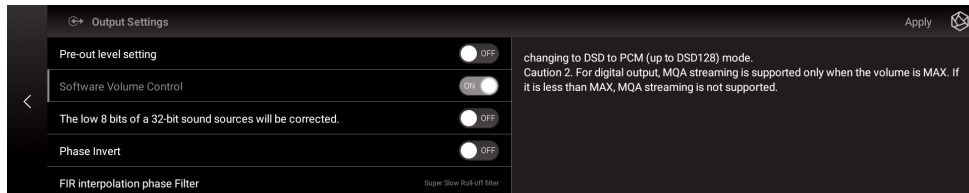

2-2-4-3. The low 8 bits of a 32-bit sound sources will be corrected

- Some DACs may produce noise when playing 32-bit audio at high sampling rates. In this case, this function can be used to reduce noise by correcting the lower 8 bits.

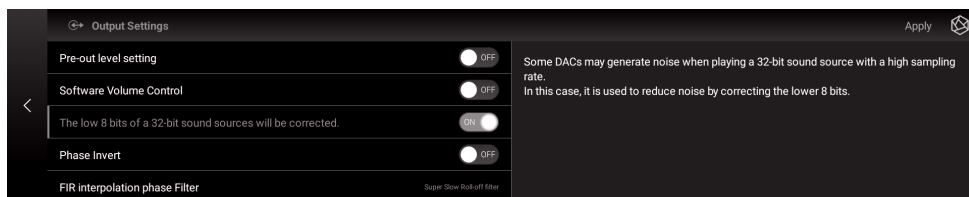

2-2-4-4. Phase Invert

- Please refer to the pin layout of the phase invert ON/OFF terminal and select the system (European, American) that is appropriate for the device you are using.

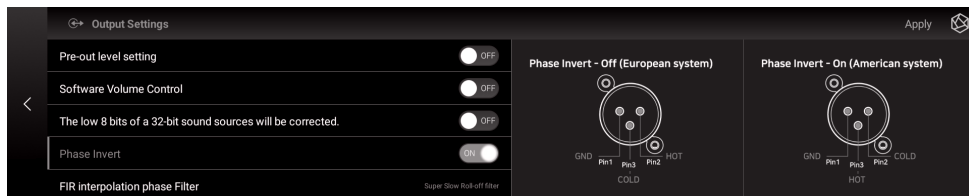

2-2-4-5. FIR interpolation phase filter

- Even if a specific filter is selected by the user, the 'Minimum Phase Slow Roll Off filter' is automatically selected to provide the best audio quality during MQA playback. FIR filters only apply to PCM data, not to DSD.

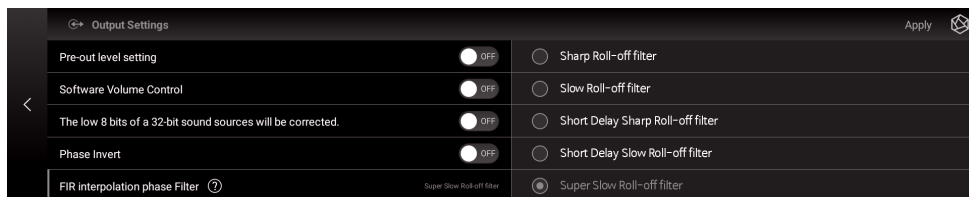

2-2-4-6. PCM Resampling Frequency

- This is the menu to set the Sampling Frequency.
- Select Original Sampling Rate if you want to output the original sound or select the desired sampling rate (44.1kHz, 48kHz, 88.2kHz, 96kHz, 176.4kHz, or 192kHz) to use the re-sampling function.
- This function is not supported for MQA, Native DSD, DoP, Video, Bluetooth, AirPlay, and Roon Ready.

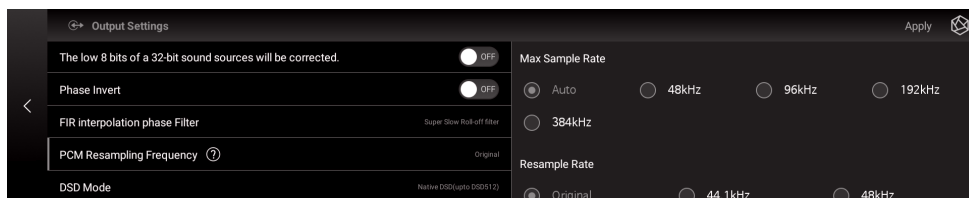

2-2-4-7. DSD Mode

- For analog output, up to DSD512 is supported in native DSD mode. (DoP mode is not supported.)
- When using DSD to PCM mode, you can convert and play back up to DSD512 via PCM.

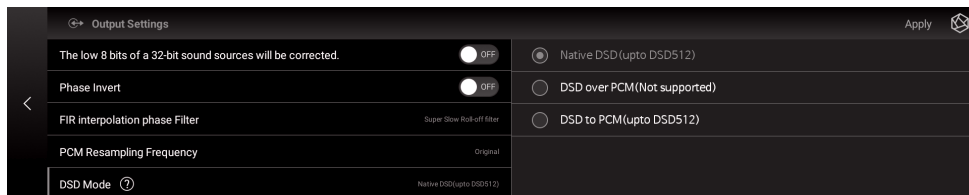

Playback

1. Default Playback

- You can play music and video files by connecting a USB storage device to a USB port on the rear of this product.
- SATA HDD/SSD can be installed at the bottom of this product. * Thickness: 2.5inch / 7mm
- You can play files on the storage device by entering the "Music/Video" - "Folder" tab.

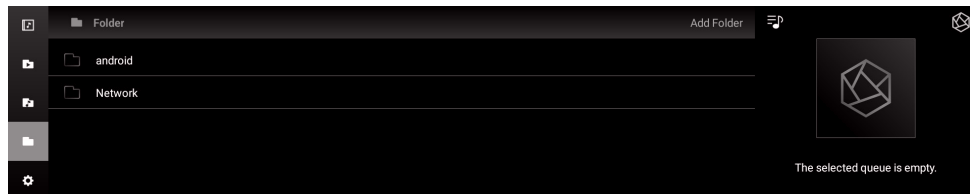

2. Media Library

- You can save the music in storage media or network shared folder as a database (DB) by scanning the media.

2-1. Activate Media Scanning

- When you connect a new storage device to a USB port on the rear of the device, a new storage detection pop-up appears.

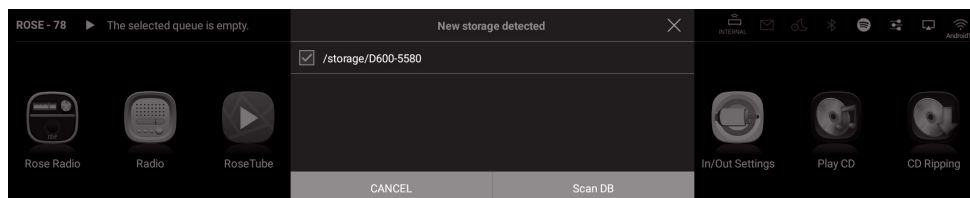

- When you select the "Scan DB" button in the new storage pop-up, media scanning starts from the connected storage device. (Depending on storage capacity, media scanning time may vary.)
- During DB scanning, the "Media Scanning" loading image is displayed at the bottom left of the main screen of this product.

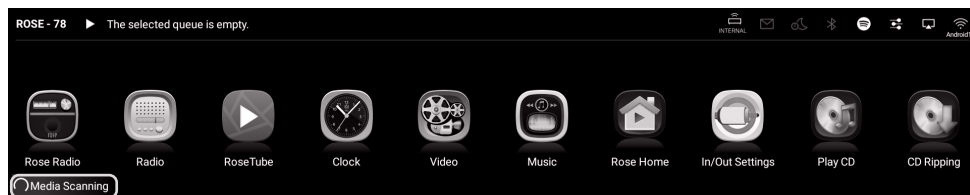

- After the DB scanning is complete, the album art and list of music and videos are displayed, and you can play the music.
- You can also add, research, and delete DB through the Music/Video and Settings menu.

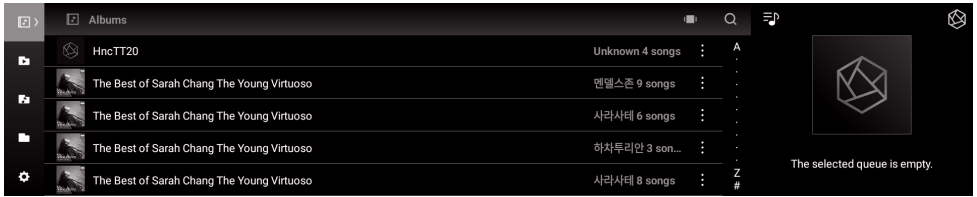

2-2. After Media Scanning

- The album list is displayed in the form of album art, and you can play the entire list in the album.
- You can sort and play music by album, artist, genre, and composer.
- You can search for music by artist and album name.
- You can save your favorite music and albums using the Playlist and Favorite features.

Supplementary Information

1. Firmware Update

1-1. Run OTA Update

- The system update pop-up appears if the latest version of the update is available while the network is connected.

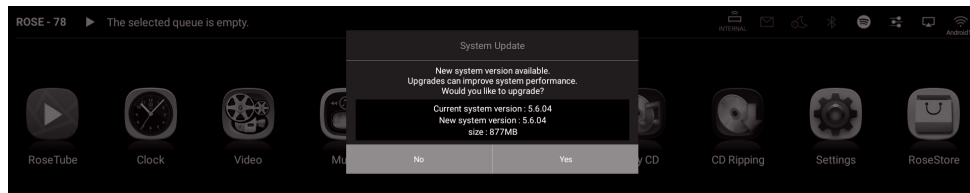

- If you select the “Yes” button in the system update pop-up, the OTA update is in progress.

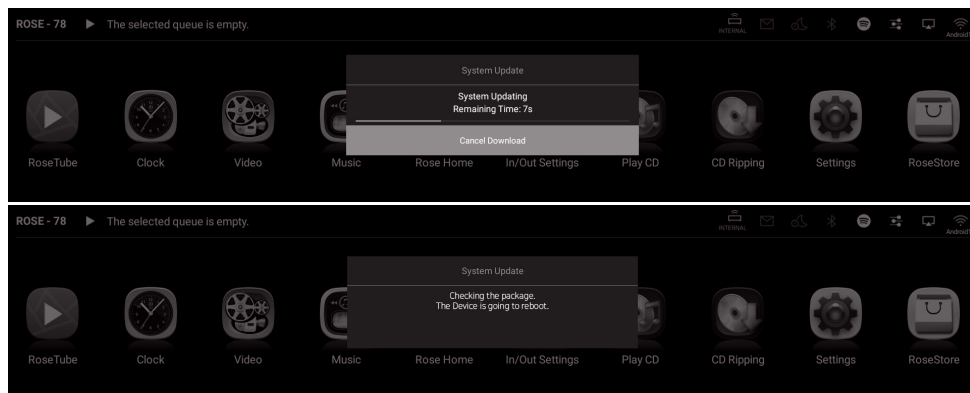

- After rebooting, the SW system update is complete.

⚠ **Caution:** Never remove the power as it may cause problems if you forcibly remove the power during the update.

1-2. Update Via Settings Menu

- If a newer version update is available, the “Update” button is displayed in the system version information in the Settings menu.

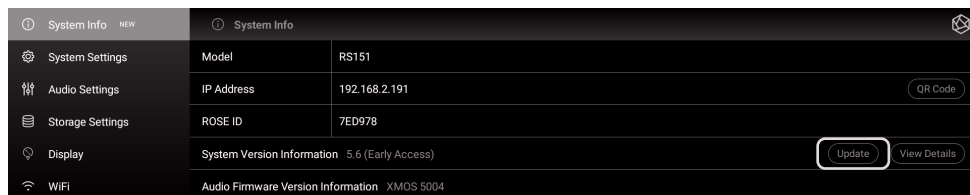

- If you select the update button, the system update pop-up is displayed.

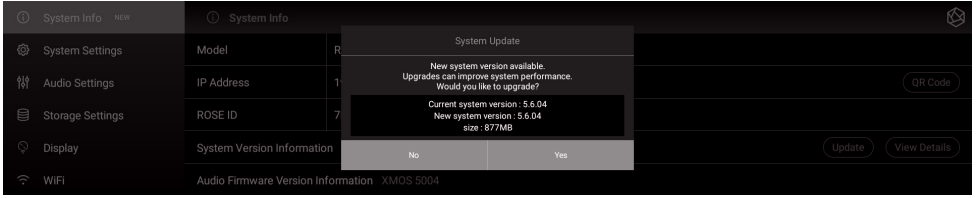

- If you select the “Yes” button in the system update pop-up, the OTA update is in progress.

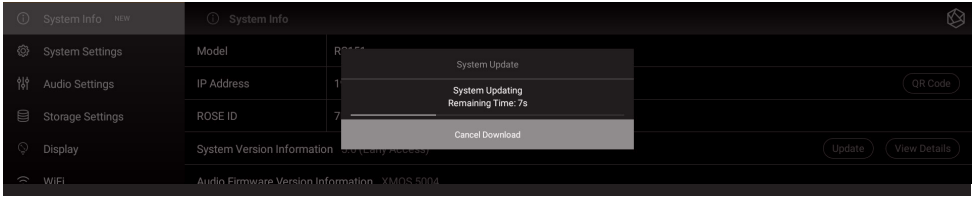

- After rebooting, the SW system update is complete.

⚠ Caution: Never remove the power as it may cause problems if you forcibly remove the power during the update.

1-3. How to Install the Firmware When the XMOS/MCU Update Pop-Up Occurs

- If a firmware update is available after the system update, the update window will automatically appear and you can proceed with the firmware update.
- Updates can occur in the following cases.

1-3-1. If there is only an XMOS update

- The device automatically reboots after executing the XMOS update.

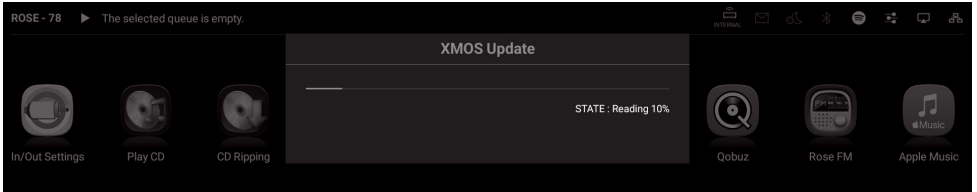
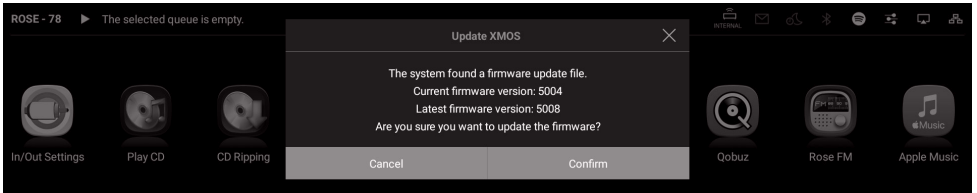

1-3-2. If there is only a MCU update

- The device automatically reboots after executing the MCU update.

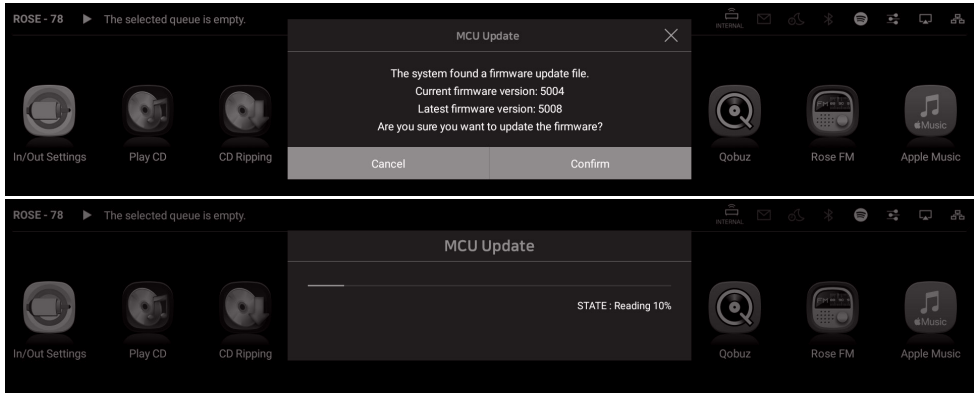

1-3-3. If there is XMOS update and MCU update

- The device automatically reboots after executing the XMOS update and the MCU update.

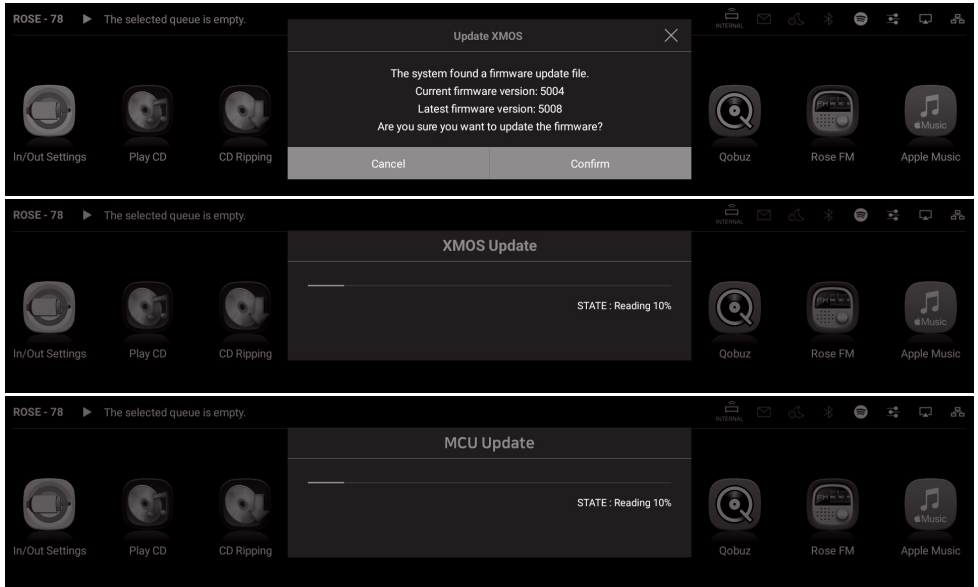

⚠ Caution: Never remove the power as it may cause problems if you forcibly remove the power during the update.

2. Factory Reset

- Factory reset is recommended when this product does not work or firmware update via Internet fails. Upon factory reset, all custom settings including DB Scan data, settings and storage data for each app, apps installed through ROSE Store, WiFi network settings, shared files, and saved playlists are reset. Reset is required after factory reset.
- This product can be reset or restored to default settings.
- You can return the system to the default settings in the "Settings - System Settings - Factory Reset" menu option.



rose

Product Specifications

Benchmark

Input Sensitivity	0dB _F 1kHz(Digital), 2V _{rms} (Analog)
Output Impedance	2.84 Ω
Output Level	9.0V _{rms} (XLR), 4.5V _{rms} (RCA)
THD + N	0.0002%(XLR), 0.0003%(RCA) (1kHz, 0dB _F)
Signal to Noise Ratio	131dB(XLR), 124dB(RCA)
Dynamic Range	Max 150dB (CCITT filter)
Stereo Crosstalk	Max -143dB (20Hz-20kHz)
Frequency Response	20Hz - 75kHz (+/-0.5dB)

Sampling Rate

PCM	44.1kHz - 768kHz(8/16/24/32bit per Sample)
DSD	DSD64(2.8MHz)/DSD128(5.6MHz)/DSD256(11.2MHz)/DSD512(22.6MHz)

Supported File Formats

Audio	WAV, FLAC, ALAC, AIFF, WMA, OGG, APE, DFF, DSF, CDA, M4A, MP3, AAC, AMR, EC3, E-EC3, MID, MPL, MP2, MPC, MPGA
Video	ASF, AVI, MKV, MP4, WMV, MPEG-1/2/4, H.263, H.264/AVC, H.265/HEVC, VC-1, VP8/9, MVC H.264/AVC (Base/Main/High/High10, Level 5.1): Up to 4Kx2K@30fps H.265/HEVC (Main/Main10, Level 5.1 High-tier): Up to 4Kx2K@60fps VP9/H.264/H.265: Up to 4Kx2K@60fps H.264/MVC/VP8 Encoding: Up to 1080p@30fps

Technical

PSU	Toroidal Linear Power Supply
CPU	Octa core RK3588
RAM	LPDDR4X 8GB
GPU	ARM Mali-G610 MC4(OpenGL, Vulkan, OpenCL)
DAC	ES9039 PRO(ESS)
Oscillator	Highly Precise Femto Clock

Inputs

Digital	USB 2.0 Type-B	PCM 32bit/768kHz, DSD512(22.6MHz)
	Coaxial	PCM 24bit/384kHz, DSD128(5.6MHz) (only DoP)
	Optical	PCM 24bit/192kHz, DSD64(2.8MHz) (only DoP)
	AES/EBU	PCM 24bit/384kHz, DSD128(5.6MHz) (only DoP)
	HDMI eARC	PCM 24bit/192kHz
Analog	Line In	
Service	USB 3.0 Type-C	
Trigger	DC 3.3V - 12V	

Outputs

Digital	USB 3.0 Type-A Coaxial Optical AES/EBU I ² S-HDMI	PCM 32bit/768kHz, DSD512(22.6MHz) PCM 24bit/384kHz, DSD128(5.6MHz) (only DoP) PCM 24bit/192kHz, DSD64(2.8MHz) (only DoP) PCM 24bit/384kHz, DSD128(5.6MHz) (only DoP) PCM 32bit/768kHz, DSD512(22.6MHz)
Analog	Unbalanced, Balanced	
Video	HDMI 2.0 (4K UHD / 60Hz)	
Trigger	DC 12V	

Network

Connectivity	Ethernet WiFi Bluetooth	10/100/1000 BASE-T(1Port) USB Dongle 5.4 aptX (A2DP1.4, Sink, AVRCP v1.6.2)
Streaming Protocol	Bluetooth, AirPlay, DLNA/UPnP, Roon Ready, Spotify Connect	
Storage	SMB	

Storage

Internal	eMMC Flash 32GB (System Use Only)
External	3 × USB 3.0 Type-A 1 × 2.5" SSD(SATA 3.0, NTFS, exFAT)

Feature

CD Ripping	Support(By external USB CD Drive)
-------------------	-----------------------------------

Power

Input Voltage	AC 110-120V, 220-240V, 50/60Hz	
Power Consumption	Standby Idle Playback	0.3W 5W 55W
Protection	6A Thermal Circuit Breaker	

Environmental

Operating °C	0~40°C
Storage °C	-10~50°C

Physical

Display	15.4" TFT LCD & Capacitive Touch Screen (FHD, eDP)
Dimension	430(W) × 319(D) × 125(H) mm
Weight	11kg
Material	Aluminum / Rust-proof Steel
Finish	Silver, Black
IR	38kHz IR Receiver

Quality Guaranteed

Model Name	RS151
Purchase Date	DD / MM / 20YY
Place of Purchase	Shop Name
	Contact Address
Serial No.	
Contact Address	
Warranty Period	Until 1 year from the date of purchase

- Name of the Company that Received the Conformity Assessment: CITECH Co., Ltd.
- Manufacturer/Country of Manufacture: CITECH Co., Ltd. / Republic of Korea
- Identification Code of the Certified Company: SYH
- Certification No.: R-R-SYH-RS151

Product Website: www.hifirose.com

- Get news about the latest events and new product information from ROSE through the newsletter.
- You can find an authorized dealer or reseller near you on the website.



Things to Check Before Contacting the Service Center

- Please restart the product if touch does not work or if the screen freezes. Press and hold the power button for more than 5 seconds to force a reboot.
- If the switch does not work while the product is in use, it may be because it was exposed to severe static electricity. Please disconnect the power cord before starting again.
- When the product is used for a long time in a confined space that does not meet the product installation conditions (p. 20), it may generate heat and become hot, affecting the life and performance of the product.
Always keep the ventilation openings on the top of the main body open so that heat dissipation inside is not disturbed.
- If the transmission is unstable or a transmission or reception failure occurs due to the nature of wireless Wi-Fi communication when using the mobile app, please move to another location and try to reconnect.
- If there is no output sound, check the input source selector of the main unit, and check that the speaker connection status, and the volume control level are not "0."
- If the remote control does not work, the battery may be empty. Replace it with a new battery.
- Content-specific files are optimized according to product characteristics, design specifications, and business needs. Therefore, even with the same content, there may be differences in volume, tone, etc. with other manufacturers and other models.

Repair Service Guide

• Free Repair

Limited to naturally occurring failures within one year from the date of purchase, which is the warranty period of the product.

• Paid Repair

If the warranty period has expired, or even if it is within the warranty period, in the following cases, the actual cost of repair (including part costs) will be charged.

- Failure due to consumer negligence during use
- Repairs or modifications made by persons other than company engineers
- Failure or damage caused by an abnormality in the power supply
- Failure due to a natural disaster

• Repair Service Application Guide

If a failure occurs during use, stop using it immediately and consult with the place of purchase or the customer support office of the company first.

• Information required for reporting

- Model name and serial number (manufacture date)
- Place and date of purchase
- Consumer information including contact information and address
- Symptoms of failure
- All other matters necessary for repair service

• Precautions for Product Delivery to the Service Center

Be sure to pack the product in the original box and inner protective material to prevent damage when delivering the product by courier. Please note that we are not responsible for damage to the product during transportation of the product in other packaging.

UK PSTI Statement of Conformity

We, Citech, Co., Ltd. hereby declares that this product complies with the applicable security requirements set out in Schedule 1 of The Product Security and Telecommunications Infrastructure (Security Requirements for Relevant Connectable Products) Regulations 2023 at the time of this Statement, required by the UK government in the Product Security & Telecommunications Infrastructure Act 2022.

Citech, Co., Ltd. will provide software security updates for this product as described on this webpage:

<https://hifirose.com/Legal/>



If you detect a vulnerability with this product, please contact us following the guidance covered on this webpage:

<https://hifirose.com/QnA?category=34zK754S49/>



* This statement was last updated on 04.04.2024.



HIFI ROSE / CITECH