



View this document in HTML
crestron.com/docs/9045



Product Manual

DM NAX[®]

Audio-over-IP Distribution Platform

Original Instructions

The U.S. English version of this document is the original instructions.

All other languages are a translation of the original instructions.

Regulatory Model: M1845004

Crestron product development software is licensed to Crestron dealers and Crestron Service Providers (CSPs) under a limited nonexclusive, nontransferable Software Development Tools License Agreement. Crestron product operating system software is licensed to Crestron dealers, CSPs, and end-users under a separate End-User License Agreement. Both of these Agreements can be found on the Crestron website at www.crestron.com/legal/software_license_agreement.

The product warranty can be found at www.crestron.com/warranty.

The specific patents that cover Crestron products are listed at www.crestron.com/legal/patents.

Certain Crestron products contain open source software. For specific information, visit www.crestron.com/opensource.

Crestron, the Crestron logo, Crestron Toolbox, DM, DM NAX, DM NVX and XiO Cloud are either trademarks or registered trademarks of Crestron Electronics, Inc. in the United States and/or other countries. Apple, AirPlay, and macOS are either trademarks or registered trademarks of Apple Inc., registered in the U.S. and other countries. Bluetooth is either a trademark or registered trademark of Bluetooth SIG, Inc. in the United States and/or other countries. Dante is either a trademark or registered trademark of Audinate Pty Ltd. in the United States and/or other countries. Deezer is either a trademark or registered trademark of Deezer société anonyme (sa) in the United States and/or other countries. SOUNDMACHINE is either a trademark or registered trademark of Easy Tempo, Inc. in the United States and/or other countries. RACO is either a trademark or registered trademark of Hubbell Incorporated in the United States and/or other countries. Active Directory and Windows are either trademarks or registered trademarks of Microsoft Corporation in the United States and/or other countries. Pandora is either a trademark or registered trademark of Pandora Media, Inc. in the United States and/or other countries. Roon and Roon Core are either trademarks or registered trademarks of Roon Labs LLC in the United States and/or other countries. SiriusXM is either a trademark or registered trademark of Sirius XM Radio Inc. in the United States and/or other countries. Spotify is either a trademark or registered trademark of Spotify Inc. in the United States and/or other countries. TIDAL is either a trademark or registered trademark of Tidal Music as Corporation Norway in the United States and/or other countries. TOSLINK is either a trademark or registered trademark of Toshiba Electronics Devices & Storage Corporation in the United States and/or other countries. USB-C is either a trademark or registered trademark of USB Implementers Forum, Inc. in the United States and/or other countries. Qobuz is either a trademark or registered trademark of Xandrie société anonyme (sa) in the United States and/or other countries. Other trademarks, registered trademarks, and trade names may be used in this document to refer to either the entities claiming the marks and names or their products. Crestron disclaims any proprietary interest in the marks and names of others. Crestron is not responsible for errors in typography or photography.

©2024 Crestron Electronics, Inc.

Contents

Overview	1
Features	1
Products	1
DM-NAX-2XLRI-1G	2
DM-NAX-8ZSA	4
Application Diagrams	6
DM-NAX-16AIN	13
Application Diagram	14
DM-NAX-4ZSA-50	15
DM-NAX-4ZSP	17
DM-NAX-AMP-X300	19
DM-NAX-AUD-IO	22
DM-NAX-AUD-USB	24
DM-NAX-BTIO-1G	26
Specifications	28
DM-NAX-2XLRI-1G Specifications	28
Specifications	28
Dimension Drawing	31
DM-NAX-8ZSA Specifications	32
Specifications	32
Dimension Drawing	35
DM-NAX-4ZSA-50 Specifications	36
Specifications	36
Dimension Drawing	39
DM-NAX-4ZSP Specifications	40
Specifications	40
Dimension Drawing	43
DM-NAX-16AIN Specifications	44
Specifications	44
Dimension Drawing	46
DM-NAX-AMP-X300 Specifications	47
Specifications	47
Dimension Drawings	50
DM-NAX-AUD-IO Specifications	51
Specifications	51
Dimension Drawing	53
DM-NAX-AUD-USB Specifications	54
Specifications	54
Dimension Drawing	56
DM-NAX-BTIO-1G Specifications	57
Specifications	57

Dimension Drawing	60
Installation	61
DM-NAX-2XLRI-1G Installation	62
In the Box	62
Mounting the Device	62
Connect the Device	65
Reset the Device	66
DM-NAX-8ZSA Installation	68
In the Box	68
Install the Device	68
Connect the Device	70
Apple® AirPlay® Setup	73
Spotify® Connect Setup	74
Observe the LED Indicators	75
Reset the Device	75
DM-NAX-4ZSA-50 Installation	77
In the Box	77
Install the Device	77
Connect the Device	81
Speaker Connections	82
Apple® AirPlay® Setup	82
Spotify® Setup	83
Observe the LED Indicators	84
Reset the Device	84
DM-NAX-4ZSP Installation	86
In the Box	86
Install the Device	86
Connect the Device	88
Apple® AirPlay® Setup	90
Spotify® Connect Setup	91
Observe the LED Indicators	92
Reset the Device	93
DM-NAX-16AIN Installation	94
In the Box	94
Install the Device	95
Connect the Device	97
Observe the LED Indicators	99
Reset the Device	100
DM-NAX-AMP-X300 Installation	101
In the Box	102
Install the Device	103
Connect the Device	107
Speaker Mode Selection Switch	107
Lo-Z Modes Selection Switch	108
Observe the LED Indicators	108

Reset the Device	109
Output Wiring Options	110
DM-NAX-AUD-IO Installation	113
In the Box	113
Mount the Device	113
Connect the Device	118
Reset the Device	119
DM-NAX-AUD-USB Installation	121
In the Box	121
Mount the Device	121
Connect the Device	126
Reset the Device	127
DM-NAX-BTIO-1G Installation	129
In the Box	129
Mount the Device	129
Connect the Device	132
Reset the Device	132
Configuration	134
DM-NAX-2XLRI-1G	135
Web Interface Configuration	135
Access the Web Interface With the Crestron Toolbox™ Application	138
Action	139
Status	143
Settings	146
Security	179
802.1x Configuration	187
DM-NAX-8ZSA	189
Web Interface Configuration	189
Access the Web Interface With the Crestron Toolbox™ Application	192
Action	193
Status	201
Settings	204
Security	237
802.1x Configuration	245
DM-NAX-4ZSA-50	247
Web Interface Configuration	247
Access the Web Interface With the Crestron Toolbox™ Application	250
Action	251
Status	258
Settings	261
Security	294
802.1x Configuration	302
DM-NAX-4ZSP	304
Web Interface Configuration	304
Access the Web Interface With the Crestron Toolbox™ Application	307

Action	308
Status	316
Settings	319
Security	347
802.1x Configuration	355
DM-NAX-16AIN	357
Web Interface Configuration	357
Access the Web Interface With the Crestron Toolbox™ Application	360
Action	361
Status	365
Settings	367
Security	375
802.1x Configuration	383
DM-NAX-AMP-X300	385
Web Interface Configuration	385
Access the Web Interface With the Crestron Toolbox™ Application (DM-NAX-AMP-X300)	387
Action	388
Status	392
Settings	396
Security	442
802.1x Configuration	450
DM-NAX-AUD-IO	451
Web Interface Configuration	451
Access the Web Interface With the Crestron Toolbox™ Application	454
Action	455
Status	459
Settings	462
Security	500
802.1x Configuration	508
DM-NAX-AUD-USB	510
Web Interface Configuration	510
Access the Web Interface With the Crestron Toolbox™ Application	513
Action	514
Status	518
Settings	521
Security	559
802.1x Configuration	567
DM-NAX-BTIO-1G	569
Web Interface Configuration	569
Front Panel Menu	572
Access the Web Interface With the Crestron Toolbox™ Application	577
Action	578
Status	582
Settings	585
Security	622

802.1x Configuration	630
Audio-over-IP Network Design	632
Minimum Network Requirements	632
Network Design Overview	633
Multicast Network Traffic	634
Precision Time Protocol	635
Quality of Service Configuration	635
Network Topologies	637
Star	637
Tree	638
Network Security	639
Network Design Considerations	640
System Installation	641
Endpoint Installation	641
Network Installation	642
Resources	643
Crestron Support and Training	643
Programmer and Developer Resources	643
Product Certificates	643

Overview

DM NAX® Audio-over-IP (AoIP) solutions are built on AES67 standards with the additional ease of configuration via a web interface, SIMPL, C#, and/or a RESTful API. It is compatible with DM NVX® endpoints through an AES67 secondary audio stream, and also with third-party AES67 solutions, including Dante® devices.

Features

- **Scalability:** DM NAX systems can scale to meet any demand. DM NAX supports up to 32 DM NAX devices in sync. In addition, DM NAX can support any combination of units for additional input-output requirements.
- **Flexibility:** Multiple input-output options are supported. Built-in streaming services and an expanding hardware lineup are available for a broad range of applications.
- **Interoperability:** DM NAX is built on AES67 AoIP standards and is compatible with any third-party AES67 solution

Products

The following products are described in this product manual:

- [DM-NAX-2XLRI-1G on page 2](#)
- [DM-NAX-8ZSA on page 4](#)
- [DM-NAX-16AIN on page 13](#)
- [DM-NAX-4ZSA-50 on page 15](#)
- [DM-NAX-4ZSP on page 17](#)
- [DM-NAX-AMP-X300 on page 19](#)
- [DM-NAX-AUD-IO on page 22](#)
- [DM-NAX-AUD-USB on page 24](#)
- [DM-NAX-BTIO-1G on page 26](#)

DM-NAX-2XLRI-1G

The DM-NAX-2XLRI-1G provides a single-gang wall mount for (2) XLR inputs. The rear of the wall plate features an Ethernet connection for power and DM NAX® audio-over-IP (AOIP) networking. The rear panel also features a five-pin line-level audio output for transmitting an audio signal to a Crestron media wall plate (MP-WP-2XLRO-1G and MP-WP-2RCAO-1G).

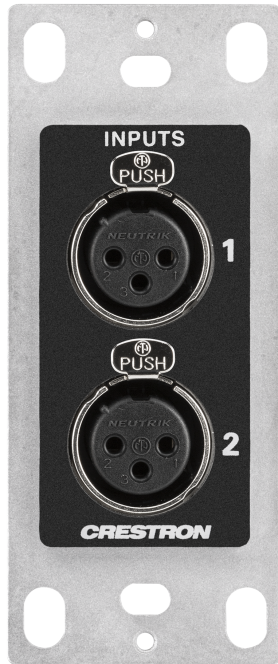

- Two XLR input connectors
- Two rear-panel line-level audio outputs
- Single-gang U.S. wall box installation
- Power over Ethernet (PoE) network powered
- Mountable in a standard US electrical box or on a rack rail via included hardware
- Connects directly to a managed network to route to or from other DM NAX® and DM NVX® devices
- Interoperable with Dante® audio networking devices via AES67 compatibility
- Streamlined configuration through a web interface
- Seamless Crestron system integration with SIMPL Windows programming

Audio-over-IP

DM NAX takes audio distribution to a whole new level by putting it on the network. The DM-NAX-2XLRI-1G sends and receives DM NAX and AES67 encoded audio over a standard IP network. A single DM NAX system with a Crestron Home OS processor can handle audio distribution between 32 DM NAX devices and supports up to 256 audio output zones. A SIMPL Windows program can handle as many DM NAX devices and zones as the network hardware will support. DM NAX devices can seamlessly pull and distribute the audio from DM NVX sources.

Line Level and Microphone Level Support

The front panel XLR connectors of the DM-NAX-2XLRI-1G can be configured for either line level or microphone level input. Each XLR input can be configured to send a +48V phantom power signal to power a connected condenser microphone.

Digital Signal Processing (DSP)

DSP capabilities such as a 5-band EQ per XLR input and level control of all input and output signal types are available to configure via the web user interface.

Encoder and Decoder Functionality

The DM-NAX-2XLRI-1G can operate as a network AV encoder and decoder. The local input sources on one amplifier can be sent as AoIP streams to DM NAX, Dante, or AES67 capable devices. Simultaneously, the DM-NAX-2XLRI-1G can receive AoIP streams from these same devices and decode them for local output.

DM-NAX-8ZSA

The Crestron DM-NAX-8ZSA is a next generation DM NAX® Audio-over-IP (AoIP) amplifier that puts Crestron multiroom audio distribution on the network. It provides eight amplified stereo zone (16-channel) outputs. Four stereo line-level outputs mirror speaker zone outputs 1-4.

A dedicated streaming service player for each of the eight zones enables complete freedom to stream different content in every zone. Full DSP capabilities are available on the line and speaker outputs.



- Robust, high-efficiency, audiophile grade amplification
- Built-in streaming services support
- 2 RU form factor, low power consumption, cool running operation
- Built-in chime support
- Voice control support for Crestron Home OS
- Provides 8 amplified stereo zones (16 channels total) of output
- 150 W/Ch. @ 8 Ω or 300 W/Ch. @ 4 Ω , with zones bridgeable up to 500 W/Ch.
- Four stereo line-level outputs mirror speaker zone outputs 1-4
- Output bussing enables linked operation of multiple adjacent zones
- Connects directly to a managed network to route to or from other DM NAX and DM NVX devices
- Interoperable with Dante® audio networking devices via AES67 compatibility
- Includes 4 stereo unbalanced analog RCA and 4 SPDIF (2 TOSLINK and 2 Coaxial) audio inputs
- Full DSP capabilities
- Individual zone power control and global standby
- Streamlined setup and adjustment via the device's web interface
- Seamless Crestron system integration with Crestron Home® OS and SIMPL Windows programming

The DM-NAX-8ZSA supports [Amazon Connected Speakers](#).

For installation information, refer to the [DM-NAX-8ZSA Quick Start](#).

Audio-over-IP

DM NAX takes audio distribution to a whole new level by putting it on the network. The DM-NAX-8ZSA sends and receives DM NAX and AES67 encoded audio over a standard IP network. A single DM NAX system with a Crestron Home OS processor can handle audio distribution between 32 DM NAX devices and supports up to 256 audio output zones. A SIMPL Windows program can handle as many DM NAX devices and zones as the network hardware will support. DM NAX devices can seamlessly pull and distribute the audio from DM NVX sources.

Streaming and Casting Services

A dedicated streaming service player for each of the zones supporting AirPlay® 2, Internet Radio, Spotify Connect™, Pandora®, SiriusXM®, TIDAL™, Deezer®, Qobuz®, SOUNDMACHINE®, Podcasts and more. The DM-NAX-8ZSA delivers streaming, routing, distribution, and amplification in a single device. Streams can be routed to other non-streaming AoIP amplifiers.

Voice Control

Amazon® Voice Services are currently only supported when using the DM-NAX-8ZSA with Crestron Home OS.

Chimes

A library of chimes is built into the unit. Chimes can be assigned to different zones to help identify them. Whenever a chime is triggered, the zone audio will duck or pause, so the chime can be clearly heard over active media until the chime concludes.

DSP

DSP capabilities such as bass and treble boost and cut, loudness, adjustable delay, speaker protection and limiting, tone profiles, a full 10-band EQ per output, and an option to have each line output at a fixed or variable level with or without DSP applied are available.

Zones can be permanently bussed together (up to 4 buses available per unit, and up to all 8 zones can join a given bus) for simultaneous routing and control, or grouped dynamically with other zones for a temporary collection of zones that play back the same media.

Encoder and Decoder Functionality

The DM-NAX-8ZSA operates simultaneously as a network AV encoder and decoder. The analog line level sources, digital S/PDIF sources or media streams on one DM NAX device can be sent to any other DM NAX or AES67 capable endpoint on the network.

Application Diagrams

This section shows DM-NAX-8ZSA device in multizone applications.

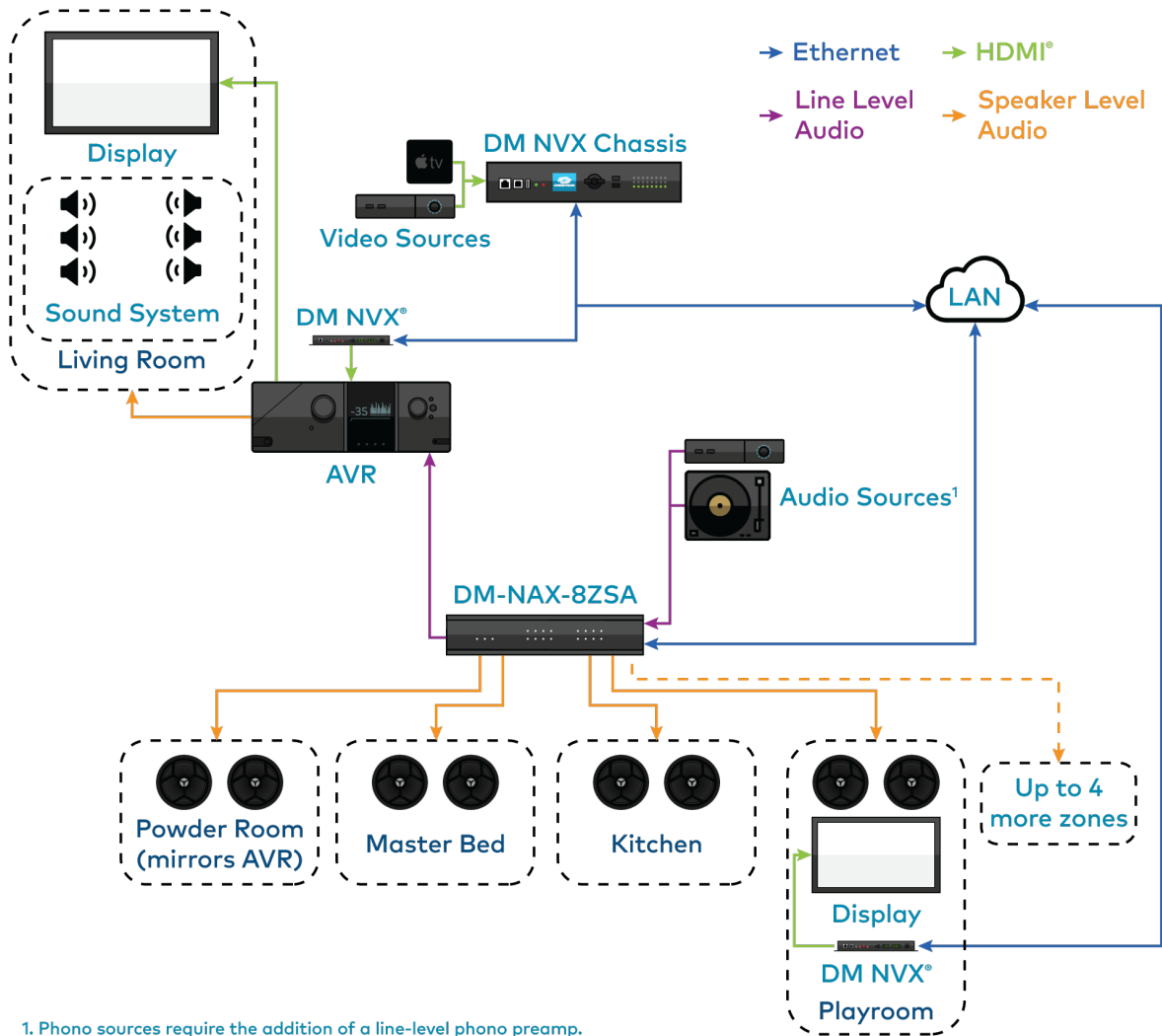

1. Phono sources require the addition of a line-level phono preamp.

NOTES:

- DM NAX devices generate multicast traffic on the network. Even a single DM NAX device connected to an unmanaged network can cause communication issues with other devices connected to the same network. For information on system installation, refer to the [Audio-over-IP Network Design on page 632](#).
- If DM NAX devices must be set up before configuring network settings on a managed switch, refer to [Port Selection on page 235](#). The **Port Selection** feature allows the DM NAX device to isolate the AoIP traffic to the secondary Ethernet port. For example, when connecting the DM NAX to a control system or authenticating streaming service accounts. This ensures that during setup, the primary Management port of the device does not receive AoIP traffic.

This application diagram shows the following setup:

- Up to eight zones of amplification and audio distribution
- Local line level input
- Local line level output to an Audio Video Receiver (AVR) mirroring a zone of amplification
- Available DM NVX audio streams to route audio from video sources to non-video zones
- Available music streaming services on up to eight DM NAX zones

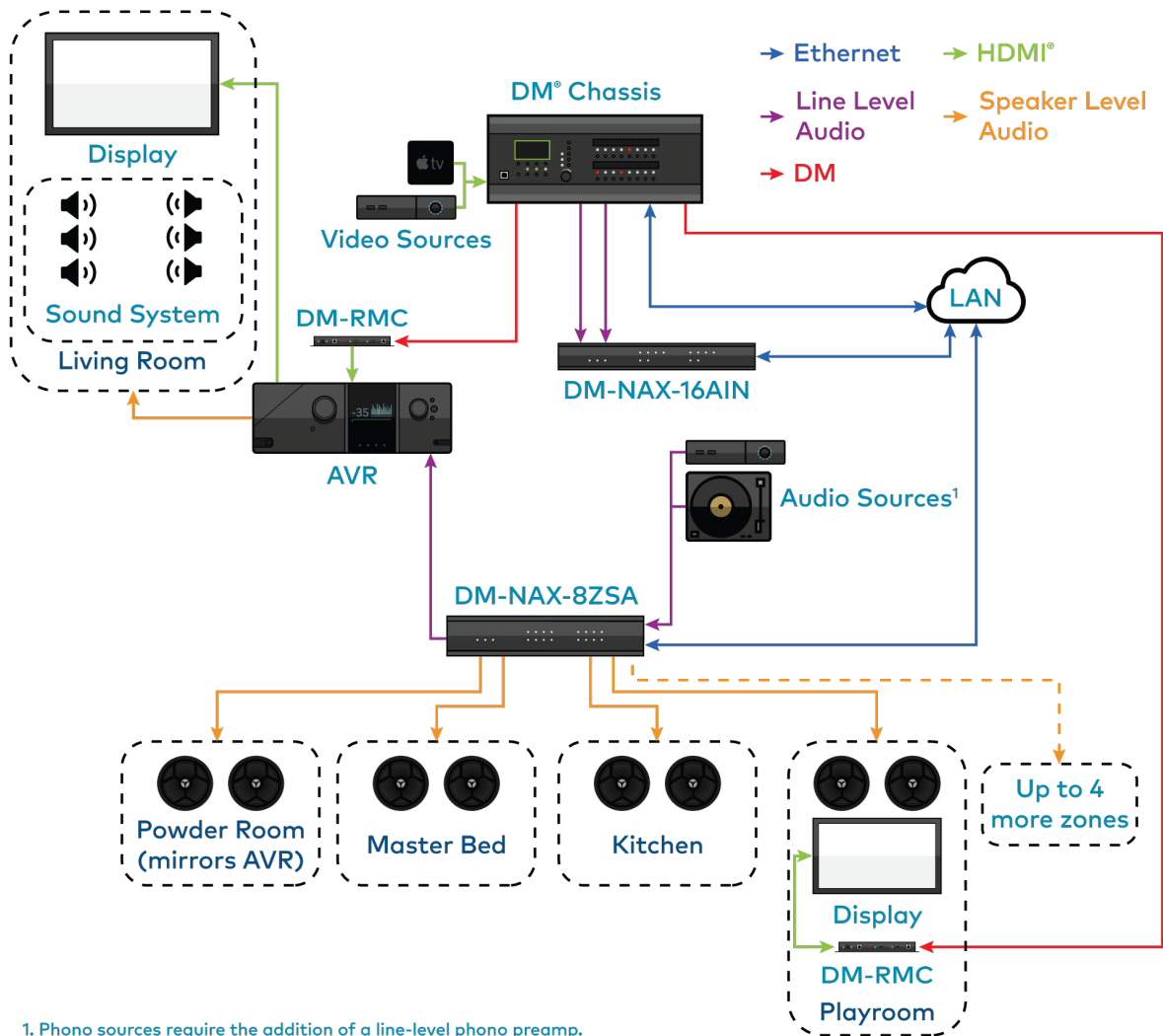

This application diagram shows the following setup:

- Up to eight zones of amplification and audio distribution
- Local line level input
- Local line level output to an AVR mirroring a zone of amplification
- Available music streaming services on up to eight DM NAX zones
- The DM-NAX-16AIN is used to transmit audio from the DM chassis' video sources onto the DM NAX network for routing to the non-video zones on the DM-NAX-8ZSA

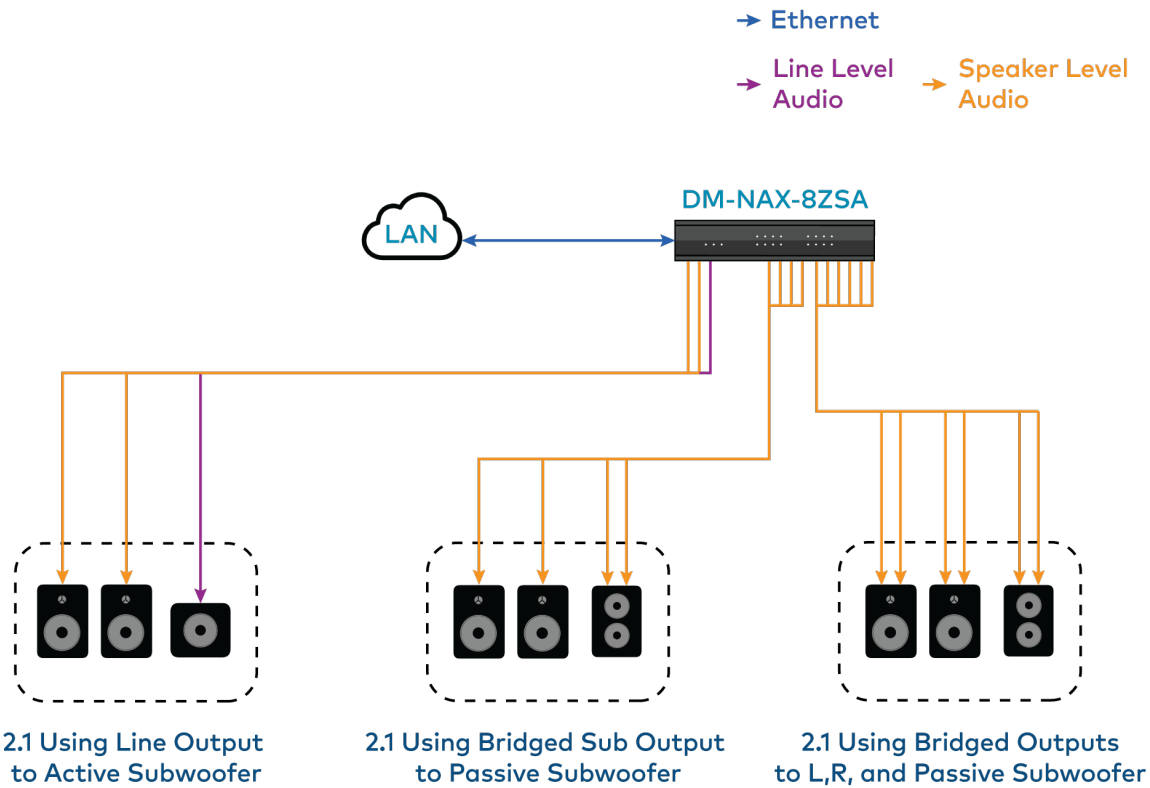

This application diagram shows different 2.1 configurations and how they affect the zone count of an DM-NAX-8ZSA. By default, a zone comprises two speaker outputs (a left and a right).

- The 2.1 configuration at the left of the diagram comprises two speaker outputs, with an additional line output that feeds the subwoofer.

NOTE: This configuration is only applicable for zones with an available line output (1 through 4).

- The middle configuration (2.1 bridged sub) comprises four speaker outputs - two left and right and two for the bridged sub.

NOTE: This configuration is only applicable when enough subsequently numbered zones are available on the amplifier. For example, the 2.1 bridged sub cannot be used on zone 8 as there is no speaker output pair 9.

- The right configuration (bridged 2.1) comprises six speaker outputs - two for the bridged left, two for the bridged right, and two for the bridged sub.

NOTE: This configuration is only applicable when enough subsequently numbered zones are available on the amplifier. For example, the 2.1 bridged sub cannot be used on zone 7 or 8 as there is no speaker output pair 9 or 10.

Having higher output-count zone configurations on a single DM-NAX-8ZSA will affect the total available zone count on a given box. For example, if you have a single bridged 2.1 configuration on an DM-NAX-8ZSA, it will lower the maximum zone count to six, as the bridged 2.1 consumes three zones worth of speaker outputs on its own.

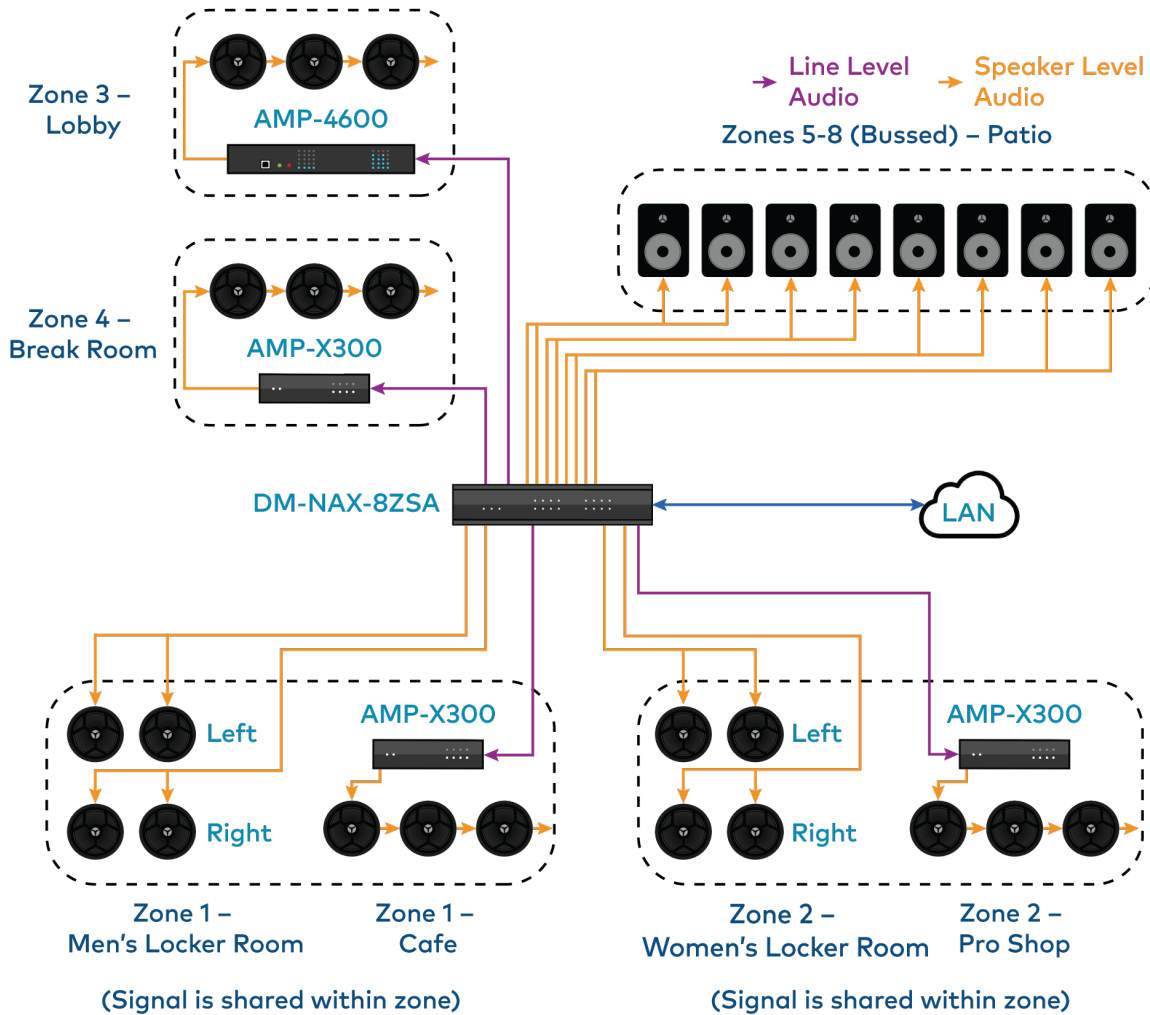

This application diagram shows the following setup:

- Mirrored zones (Zone 1 and Zone 2 each have two rooms receiving the same audio signal)
- Parallel wiring of low impedance speakers in two Locker Room areas

NOTE: This is a parallel wiring of 8 Ω speakers for a total supported load of 4 Ω per channel. Parallel wiring lowers the effective impedance of the connected loads, so make sure the speakers impedance matches the supported impedance levels from the DM-NAX-8ZSA.

- Using the line outputs of the DM-NAX-8ZSA to feed high-impedance amplifiers (AMP-X300s and AMP-4600) for long speaker runs

- Bussing to multiple zones to feed a large group of low-impedance speakers with the same signal and shared controls

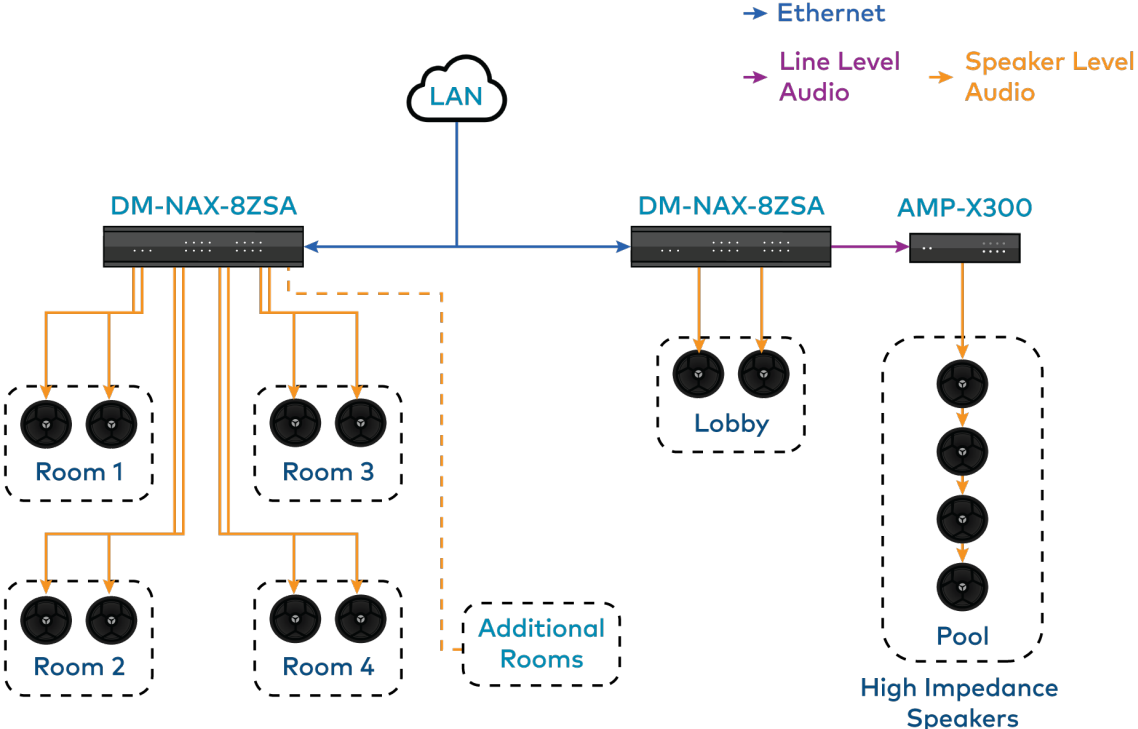

This application diagram shows a commercial setup using casting service streaming applications. For example, in a hotel, each room can receive a cast from a third-party device. The Lobby and Pool zones can exist on another DM-NAX-8ZSA unit that is on the same LAN or on a separate VLAN or WAP to cast to/control those zones.

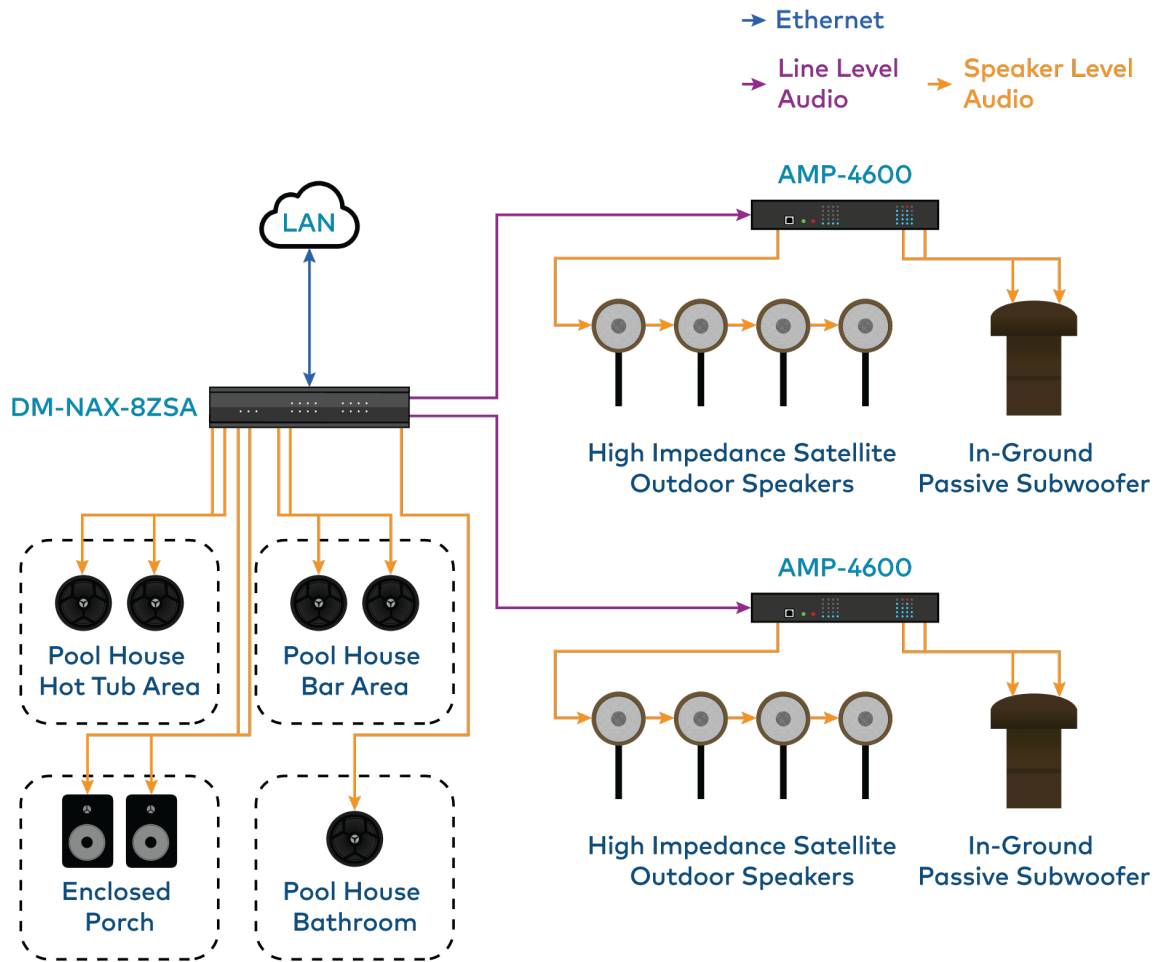

This application diagram shows zones using only the line outputs. Line outputs 1 and 2 feed high impedance amplifiers driving speakers for large outdoor spaces and speaker zone outputs 5-8 feed low-impedance indoor spaces without overlap of signals. The LAN cloud shows that any individual applications can exist as part of a large DM NAX system.

DM-NAX-16AIN

The Crestron DM NAX® Audio-over-IP (AoIP) encoder (DM-NAX-16AIN) provides 16 local stereo audio inputs to a DM NAX Crestron multiroom audio distribution network. It provides 8 digital inputs comprised of 4 SPDIF TOSLINK® connectors and 4 SPDIF coaxial connectors. Each digital input supports 2-channel PCM audio. The DM-NAX-16AIN also provides 8 analog stereo inputs. Inputs 1-4 offer balanced 5-pin terminal block connectors in parallel with unbalanced RCA connectors, and inputs 5-8 offer RCA connectors.



- 1 RU form factor, low power consumption, cool running operation
- Provides 16 stereo inputs for a DM NAX AoIP network
- Includes 8 SPDIF (4 TOSLINK and 4 Coaxial) digital audio inputs, 8 stereo unbalanced analog RCA inputs, and 4 stereo balanced analog terminal block connector inputs in parallel with RCA inputs 1-4
- Connects directly to a managed network to route to other DM NAX and DM NVX devices
- Adjustable level compensation for each local input
- Interoperable with Dante® audio networking devices via AES67 compatibility
- Streamlined setup and adjustment via the device's web interface
- Seamless Crestron system integration with Crestron Home® OS and SIMPL Windows programming

For installation information, refer to the [DM-NAX-16AIN Quick Start](#).

Audio-over-IP

DM NAX takes audio distribution to a whole new level by putting it on the network. The DM-NAX-16AIN sends DM NAX and AES67 encoded audio over a standard IP network. A single DM NAX system with a Crestron Home OS processor can handle audio distribution between 32 DM NAX devices and supports up to 256 audio output zones. A SIMPL Windows program can handle as many DM NAX devices and zones as the network hardware will support. DM NAX devices can seamlessly pull and distribute the audio from DM NVX sources.

Application Diagram

This section shows DM-NAX-16AIN device in a multizone application.

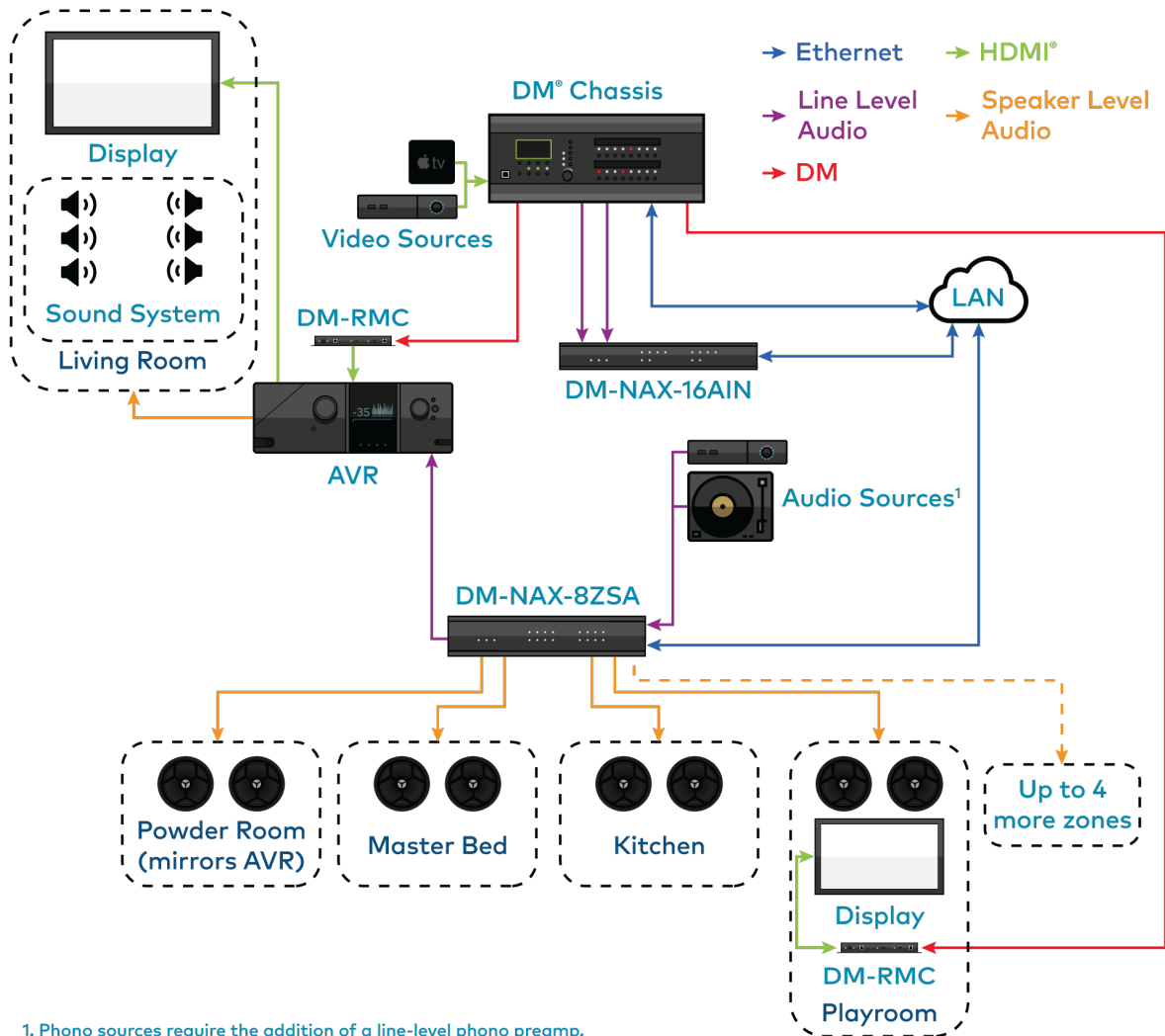

1. Phono sources require the addition of a line-level phono preamp.

This application diagram shows the following setup:

- Up to eight zones of amplification and audio distribution
- Local line level input
- Local line level output to an AVR mirroring a zone of amplification
- Available music streaming services on up to eight DM NAX zones
- The DM-NAX-16AIN is used to transmit audio from the DM chassis' video sources onto the DM NAX network for routing to the non-video zones on the DM-NAX-8ZSA

DM-NAX-4ZSA-50

The Crestron DM-NAX-4ZSA-50 is a next generation DM NAX® Audio-over-IP (AoIP) amplifier that puts Crestron multiroom audio distribution on the network. It provides four amplified stereo zone (8-channel) outputs and an independent line level zone (2-channel) output.

A dedicated streaming service player for each of the four zones enables complete freedom to stream different content in every zone. Full DSP capabilities are available on the speaker outputs.



- Audio-over-IP (AoIP) amplifier
- Built-in streaming services support
- Full DSP capabilities
- Gallium Nitride (GaN) Class D amplification
- 50 W of output power per channel
- Provides four amplified output zones and one additional line-level output zone
- 1 RU high, half-rack width modular form factor
- Interoperable with Dante® audio networking devices via AES67 compatibility
- Built-in chime support
- Streamlined configuration through a web interface
- Seamless Crestron system integration with SIMPL Windows programming

The DM-NAX-4ZSA-50 supports [Amazon Connected Speakers](#).

Audio-over-IP

The DM-NAX-4ZSA-50 sends and receives DM NAX and AES67 encoded audio over a standard IP network. A single DM NAX system with a Crestron Home OS processor can handle audio distribution between 32 DM NAX devices and supports up to 256 audio output zones. A SIMPL Windows program can handle as many DM NAX devices and zones as the network hardware will support. DM NAX devices can seamlessly pull and distribute the audio from DM NVX sources.

Streaming and Casting Services

A dedicated streaming service player is built-in for each zone, supporting AirPlay® 2, Internet Radio, Spotify Connect™, Pandora®, SiriusXM®, TIDAL™, Deezer®, Qobuz®, Podcasts and more. The DM-NAX-4ZSA-50 delivers streaming, routing, distribution, and amplification in a single device. Streams can be routed to other non-streaming AoIP devices.

Chimes

A library of chimes is built into the unit. Chimes can be assigned to different zones to help identify them. Whenever a chime is triggered, the zone audio will duck or pause, so the chime can be clearly heard over active media until the chime concludes.

Digital Signal Processing (DSP)

DSP capabilities such as bass and treble boost and cut, loudness, adjustable delay, speaker protection and limiting, tone profiles, a full 10-band EQ per output, and an option to have line output as a fixed or variable level with or without DSP applied are available. Speaker profiles for first and third party speaker models are built in to simplify output DSP tuning.

Encoder and Decoder Functionality

The DM-NAX-4ZSA-50 can operate as a network AoIP encoder and decoder. The local input sources on one amplifier can be sent as AoIP streams to DM NAX, Dante, or AES67 capable devices. Simultaneously, the DM-NAX-4ZSA-50 can receive AoIP streams from these same devices and decode them for local output.

Modular Design

The DM-NAX-4ZSA-50 is housed in a half-width rack-mountable form factor that can be installed individually or ganged together in a single rack space. The amplifier is high-density stackable with other Crestron DM NAX or X-Series amplifiers, allowing multiple units to be installed vertically in an equipment rack without needing extra ventilation space. Rack mount parts are included, so no additional mounting accessories or rack shelves are required.

Whether mounting in a rack or placing on a shelf, it is easy to combine two amplifiers into a single, full rack-width assembly.

Gallium Nitride (GaN) Amplification

The DM-NAX-4ZSA-50 is the first Crestron amplifier to feature GaN Class D technology. GaN amplification allows higher output power to fit into small form factors without sacrificing efficiency or audio performance. The DM-NAX-4ZSA-50 is capable of 50 W per channel of amplifier output power in a half-width 1RU housing that matches the depth of the [DM-NAX-AMP-X300](#).

DM-NAX-4ZSP

The Crestron DM-NAX-4ZSP is a next generation Audio-over-IP (AoIP) preamplifier that puts Crestron multiroom audio distribution on the network. It provides four stereo zone (8-channel) line-level outputs. A dedicated streaming service player enables streaming different content in each of the four zones.



- Built-in streaming services support
- 1 RU form factor, low power consumption, cool running operation
- Built-in chime support
- Voice control support for Crestron Home OS
- Provides 4 stereo zones (8 channels total) of line-level output
- Output bussing enables linked operation of multiple adjacent zones
- Connects directly to a managed network to route to or from other DM NAX and DM NVX devices
- Interoperable with Dante® audio networking devices via AES67 compatibility
- Includes 4 stereo unbalanced analog RCA and 4 SPDIF (2 TOSLINK and 2 Coaxial) audio inputs
- Full DSP capabilities
- Streamlined setup and adjustment via the device's web interface
- Seamless Crestron system integration with Crestron Home® OS and SIMPL Windows programming

For installation information, refer to the [DM-NAX-4ZSP Quick Start](#).

Audio-over-IP

DM NAX takes audio distribution to a whole new level by putting it on the network. The DM-NAX-4ZSP sends and receives DM NAX and AES67 encoded audio over a standard IP network. A single DM NAX system with a Crestron Home OS processor can handle audio distribution between 32 DM NAX devices and supports up to 256 audio output zones. A SIMPL Windows program can handle as many DM NAX devices and zones as the network hardware will support. DM NAX devices can seamlessly pull and distribute the audio from DM NVX sources.

Streaming and Casting Services

A dedicated streaming service player for each of the zones supporting AirPlay® 2, Internet Radio, Spotify Connect™, Pandora®, SiriusXM®, TIDAL™, Deezer®, Qobuz®, SOUNDMACHINE®, Podcasts and more. The DM-NAX-4ZSP delivers streaming, routing, distribution, and amplification in a single device. Streams can be routed to other non-streaming AoIP amplifiers.

Chimes

A library of chimes is built into the unit. Chimes can be assigned to different zones to help identify them. Whenever a chime is triggered, the zone audio will duck or pause, so the chime can be clearly heard over active media until the chime concludes.

DSP

DSP capabilities such as bass and treble boost and cut, loudness, adjustable delay, speaker protection and limiting, tone profiles, a full 10-band EQ per output, and an option to have each line output at a fixed or variable level with or without DSP applied are available.

Zones can be permanently bussed together (up to 2 buses available per unit, and up to all 4 zones can join a given bus) for simultaneous routing and control, or grouped dynamically with other zones for a temporary collection of zones that play back the same media.

Encoder and Decoder Functionality

The DM-NAX-4ZSP operates simultaneously as a network AV encoder and decoder. The analog line level sources, digital S/PDIF sources or media streams on one DM NAX device can be sent to any other DM NAX or AES67 capable endpoint on the network.

DM-NAX-AMP-X300

The DM-NAX-AMP-X300 is a high performance, space saving, energy efficient, professional grade Audio-over-IP (AoIP) amplifier. Supporting DM NAX, Dante, AES67, and local inputs, all with full DSP capabilities, this multichannel amplifier is suitable for both residential and commercial configurations.



- Audio-over-IP (AoIP) amplifier
- Native Dante® mode
- Full DSP capabilities
- Streamlined configuration through a web interface
- ENERGY STAR® certified power amplifier
- 1 RU high, half-rack width form factor supports surface and rack mounting
- Configurable for Lo-Z (4/8 Ω) or Hi-Z (70V or 100V) operation
- Configurable for 4 x up to 75 W output, 2 x up to 150 W output, 1 x up to 300 W (bridged) output, and 2 x up to 75 W + 1 x up to 150 W (bridged) output
- Matrix mixing of any input to any output
- Always On feature allows constant on connection with very low power consumption
- Connects directly to a managed network to route to or from DM NAX/DM NVX®, AES67, or Dante devices
- Supports mic/line level analog inputs and balanced/unbalanced line level outputs
- Individual zone power control and global standby
- Seamless Crestron system integration with Crestron Home® OS and SIMPL Windows programming

Audio-over-IP

DM NAX takes audio distribution to a whole new level by putting it on the network. The DM-NAX-AMP-X300 sends and receives DM NAX, Dante, and AES67 encoded audio over a standard IP network. A single DM NAX system with a Crestron Home OS processor can handle audio distribution between 32 DM NAX devices and supports up to 256 audio output zones. A SIMPL Windows program can handle as many DM NAX devices and zones as the network hardware will support. DM NAX devices can seamlessly pull and distribute the audio from DM NVX sources.

Digital Signal Processing (DSP)

The DM-NAX-AMP-X300 has two DSP modes. Residential mode enables the quick and easy configuration of layout, speaker protection output limits, and speaker profiles for each zone. In Commercial mode, make full use of the DM-NAX-AMP-X300's true mixing matrix as well as advanced options for equalization and dynamics processing on each individual speaker, line, and network channel.

Encoder and Decoder Functionality

The DM-NAX-AMP-X300 can operate as a network AV encoder and decoder. The local input sources on one amplifier can be sent as AoIP streams to DM NAX, Dante, or AES67 capable devices. Simultaneously, the DM-NAX-AMP-X300 can receive AoIP streams from these same devices and decode them for local output.

Lo-Z (4/8 Ω) and Hi-Z (70V or 100V) Output

The DM-NAX-AMP-X300 is a 4-channel amplifier (up to 75 W per channel) which can also be configured for 3-channel bridged operation (up to 75 W per single ended channel and up to 150 W for the bridged channel), 2-channel bridged operation (up to 150 W per channel), or 1 channel bridged operation (up to 300 W). A choice of Lo-Z outputs to drive 4- or 8- Ω speakers, or Hi-Z outputs to drive a distributed speaker system (70V or 100V) can be used. Balanced/Unbalanced inputs are provided for connection to two stereo or four mono sources through detachable terminal blocks.

ENERGY STAR® Certified

An energy-efficient design enables the DM-NAX-AMP-X300 to meet demanding ENERGY STAR requirements. In addition to its high efficiency under operation, the amplifier draws no added inrush current during power-up, thereby reducing AC circuit requirements and allowing multiple amplifiers to be connected to a single switched circuit. To reduce energy usage further, the DM-NAX-AMP-X300 can be configured to enter a low-power standby state if no input signal is detected on either channel for 25 minutes. Signal detection sensitivity has been optimized to improve response time when triggering the amplifier to the on state, allowing it to return to full operation within a half-second. The REMOTE input can be connected to a contact closure to place the amplifier outputs in controlled standby mode.

Modular Design

The DM-NAX-AMP-X300 is housed in a half-width rack-mountable form factor that can be installed individually or ganged together in a single rack space. The amplifier is high-density stackable with other Crestron modular amps, allowing multiple units to be installed vertically in an equipment rack without needing extra ventilation space. Rack and surface mount parts are included, so no additional mounting accessories or rack shelves are required.

Whether mounting in a rack, attaching to a flat surface, or placing on a shelf, it is easy to combine two amplifiers into a single, full rack-width assembly.

Fully Protected

The DM-NAX-AMP-X300 features protection against overheating, shorted or overloaded speaker lines, excessive input signals, and other faults. In the case of a shorted speaker line or overheating condition, paired outputs mute automatically until the fault condition is resolved. In the event of a prolonged fault, all outputs mute and the amplifier shuts down.

DM-NAX-AUD-IO

The DM-NAX-AUD-IO is a DM NAX® encoder and decoder with support for analog line-level audio input and output. The device is housed in a versatile form factor that can be mounted in a single-gang standard electrical box, under a table, or on a rack rail. An additional polycarbonate label is included with rotated text to make the front panel more legible in electrical box installations. The rear panel of the device features an Ethernet connection for PoE, Audio over IP (AoIP), and control.

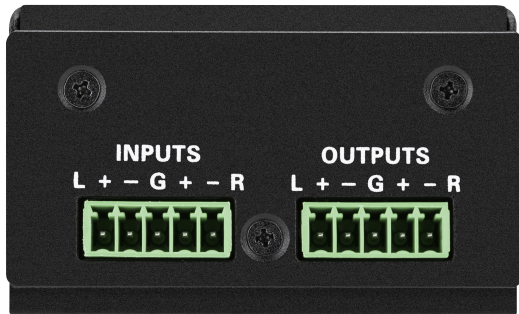

- Line-level, balanced/unbalanced analog audio input and output via detachable terminal block connectors
- Power over Ethernet (PoE) network powered
- Mountable in a standard US electrical box, under a table, or on a rack rail via included hardware
- Connects directly to a managed network to route to or from other DM NAX® and DM NVX® devices
- Interoperable with Dante® audio networking devices via AES67 compatibility
- Streamlined configuration through a web interface
- Seamless Crestron system integration with SIMPL Windows programming

Audio-over-IP

DM NAX takes audio distribution to a whole new level by putting it on the network. The DM-NAX-AUD-IO sends and receives DM NAX and AES67 encoded audio over a standard IP network. A single DM NAX system with a Crestron Home OS processor can handle audio distribution between 32 DM NAX devices and supports up to 256 audio output zones. A SIMPL Windows program can handle as many DM NAX devices and zones as the network hardware will support. DM NAX devices can seamlessly pull and distribute the audio from DM NVX sources.

Digital Signal Processing (DSP)

DSP capabilities such as bass and treble boost and cut, loudness, adjustable delay, tone profiles, and a full 10-band EQ per output are available on each output channel of the DM-NAX-AUD-IO.

Encoder and Decoder Functionality

The DM-NAX-AUD-IO can operate as a network AV encoder and decoder. The local input sources on the adapter can be sent as AoIP streams to DM NAX, Dante, or AES67 capable devices. Simultaneously, the DM-NAX-AUD-IO can receive AoIP streams from these same devices and decode them for local output.

DM-NAX-AUD-USB

The DM-NAX-AUD-USB is a DM NAX® encoder and decoder with support for USB audio and analog line-level audio input and output. The device is housed in a versatile form factor that can be mounted in a single-gang standard electrical box, under a table, or on a rack rail. An additional polycarbonate label is included with rotated text to make the front panel more legible in electrical box installations. Two 1/8 in. (3.5 mm) TRS connectors for analog line-level audio input and output are also included on the front panel. The rear panel of the device features an Ethernet connection for PoE, Audio over IP (AoIP), and control.



- USB Audio Class 1 (UAC1) device with bidirectional stereo USB audio support
- Power over Ethernet (PoE) network powered
- Line-level, unbalanced analog audio input and output via 1/8 in. (3.5 mm) TRS connectors
- Mountable in a standard US electrical box, under a table, or on a rack rail via included hardware
- Connects directly to a managed network to route to or from other DM NAX® and DM NVX® devices
- Interoperable with Dante® audio networking devices via AES67 compatibility
- Streamlined configuration through a web interface
- Seamless Crestron system integration with SIMPL Windows programming

USB Audio

A USB-C® connector is built-in to the front panel of the DM-NAX-AUD-USB, allowing for bidirectional stereo USB audio transfer at rates up to 24-bit/48 kHz. This stereo signal can be output as a DM NAX AoIP stream onto the network or as an unbalanced line-level analog signal from the local 1/8 in. (3.5 mm) audio output connector.

Audio-over-IP

DM NAX takes audio distribution to a whole new level by putting it on the network. The DM-NAX-AUD-USB sends and receives DM NAX and AES67 encoded audio over a standard IP network. A single DM NAX system with a Crestron Home OS processor can handle audio distribution between 32 DM NAX devices and supports up to 256 audio output zones. A SIMPL Windows program can handle as many DM NAX devices and zones as the network hardware will support. DM NAX devices can seamlessly pull and distribute the audio from DM NVX sources.

Digital Signal Processing (DSP)

DSP capabilities such as bass and treble boost and cut, loudness, adjustable delay, tone profiles, and a full 10-band EQ per output are available on each output channel of the DM-NAX-AUD-USB.

Encoder and Decoder Functionality

The DM-NAX-AUD-USB can operate as a network AV encoder and decoder. The local input sources on the adapter can be sent as AoIP streams to DM NAX, Dante, or AES67 capable devices. Simultaneously, the DM-NAX-AUD-USB can receive AoIP streams from these same devices and decode them for local output.

DM-NAX-BTIO-1G

The DM-NAX-BTIO-1G is a DM NAX® encoder and decoder with support for Bluetooth® wireless and analog line-level wired audio input and output, housed in a single-gang wall plate form factor. The front panel features an OLED display and four buttons for device pairing and menu navigation. Two 1/8 in. (3.5 mm) TRS connectors for stereo unbalanced analog line-level audio input and output are concealed under a front panel door. The rear panel of the wall plate features an Ethernet connection for PoE, Audio over IP (AoIP), and control.



- Built-in Bluetooth® wireless audio input support
- Front panel OLED display provides metadata readout and device setup menus
- Single-gang U.S. wall box installation
- Power over Ethernet (PoE) network powered
- Stereo unbalanced analog line-level audio input and output via 3.5 mm TRS connectors
- Mountable in a standard US electrical box or on a rack rail via included hardware
- Connects directly to a managed network to route to or from other DM NAX® and DM NVX® devices
- Interoperable with Dante® audio networking devices via AES67 compatibility
- Streamlined configuration through front panel push buttons and a web interface
- Seamless Crestron system integration with SIMPL Windows programming

Bluetooth® Wireless Connectivity

Bluetooth wireless audio support is built-in to the DM-NAX-BTIO-1G, allowing a stereo audio signal (such as an album or podcast) to be transmitted from a smart phone or other source device to the wall plate. This signal can be output as a DM NAX AoIP stream onto the network to distribute the content throughout several rooms or as an unbalanced line-level analog signal from the local 3.5 mm audio output connector. Metadata for the Bluetooth audio stream can be displayed on the front panel, and up to seven previous source device connections can be recalled.

Audio-over-IP

DM NAX takes audio distribution to a whole new level by putting it on the network. The DM-NAX-BTIO-1G sends and receives DM NAX and AES67 encoded audio over a standard IP network. A single DM NAX system with a Crestron Home OS processor can handle audio distribution between 32 DM NAX devices and supports up to 256 audio output zones. A SIMPL Windows program can handle as many DM NAX devices and zones as the network hardware will support. DM NAX devices can seamlessly pull and distribute the audio from DM NVX sources.

Encoder and Decoder Functionality

The DM-NAX-BTIO-1G can operate as a network AV encoder and decoder. The local input sources on the wall plate can be sent as AoIP streams to DM NAX, Dante, or AES67 capable devices. Simultaneously, the DM-NAX-BTIO-1G can receive AoIP streams from these same devices and decode them for local output.

Front Panel Controls and Display

The DM-NAX-BTIO-1G features four front panel push buttons and a 128 x 64 dot matrix OLED display. The push buttons allow local volume control and Bluetooth pairing, with volume feedback and pairing status reflected in real time on the display. Metadata for Bluetooth media and basic configuration menus are also shown on the display.

Both the display and push buttons can be disabled via the configuration web interface or programming for applications where a more discreet or secure installation is required.

Specifications

Refer to the following sections for more information on the specifications for various DM NAX devices.

- [DM-NAX-2XLRI-1G](#)
- [DM-NAX-8ZSA](#)
- [DM-NAX-4ZSA-50](#)
- [DM-NAX-4ZSP](#)
- [DM-NAX-16AIN](#)
- [DM-NAX-AMP-X300](#)
- [DM-NAX-AUD-IO](#)
- [DM-NAX-AUD-USB](#)
- [DM-NAX-BTIO-1G](#)

DM-NAX-2XLRI-1G Specifications

Product specifications for the DM-NAX-2XLRI-1G are provided below.

Specifications

Audio

Input Signal Types	Balanced/unbalanced analog line/mic-level; DM NAX/AES67 audio-over-IP
Output Signal Types	Balanced/unbalanced analog line-level; DM NAX/AES67 audio-over-IP
Source Compensation	±10.0 dB per input
Input Monitoring	Source Signal Detect
Frequency Response (at line-level output)	From mic-level input: 20 Hz to 20 kHz ±1.0 dB; From line-level input: 20 Hz to 20 kHz +0.1/-1.0 dB
THD+N (at line-level output)	From mic-level input: 0.3% @ 1 kHz, max output From line-level input: 0.005% @ 1 kHz, max output
S/N Ratio (at line-level output)	From analog input: 105 dB, 20 Hz to 20 kHz, A-weighted; From digital input: 111 dB, 20 Hz to 20 kHz, A-weighted
Balance Control	Left/right adjustable
EQ Filter Types	EQ, High Pass, Low Pass, Treble Shelf, Bass Shelf, Notch
EQ Center Frequency	10 Hz to 20 kHz per band
EQ Gain	+20/-40 dB per band
EQ Bandwidth	0.1 to 4.0 octaves per band

Connectors

INPUTS 1-2	(2) Balanced XLR input ports Line or microphone-level audio inputs; Mic-level maximum gain: 60 dB Mic-level maximum signal level: 2Vrms; Mic-level channel separation: 70 dB @ 60 dB gain @ 1 kHz; Line-level maximum signal level: +21 dBu (8.7Vrms) Impedance: >10 kΩ; +48V phantom power is available when used as mic-level inputs
OUTPUT L-R	(1) 5-pin 3.5 mm screw terminal block; Balanced line-level audio output; Pins 1-2: Left channel output; Pin 3: Shared ground; Pins 4-5: Right channel output; Maximum signal level: +14.7 dBu (4.2Vrms) Impedance: 200 Ω; Channel separation: 100 dB @ 1 kHz
G	(1) 6-32 screw; Chassis ground lug
ETHERNET PoE	(1) 8-pin RJ-45 connector, female; 100BASE-TX/1000BASE-T Ethernet port

Controls and Indicators

ETHERNET PoE	Left amber LED indicates 1000 Mb link status; Left green LED indicates 100 Mb link status; Flashing right amber LED indicates Ethernet activity
SETUP	(1) Push button: Used for factory reset procedures; (1) LED, illuminates red when the button is pressed, flashes red when reset has been initiated

Power

PoE	IEEE 802.3af Class 0 (12.95 W) compliant; Compatible with IEEE 802.3af compliant Ethernet switch or third-party PoE compliant PSE
Power Consumption	2.9 W

Environmental

Temperature	32° to 95° F (0° to 35° C)
Humidity	10% to 95% RH (noncondensing)
Heat Dissipation	9.9 BTU/hr

Construction

Chassis	Metal, black and silver finish, vented sides
Mounting	Mountable on the following: 1-gang U.S. electrical box or plaster ring (not included), 3.5 in. (26 mm) electrical box depth recommended; Rack rail

Dimensions

Height	4.12 in. (105 mm)
Width	1.72 in. (44 mm)
Depth	2.14 in. (55 mm)

Weight

6 oz. (170 g)

Compliance

Regulatory Model: M1845004

IC, FCC Part 15 Class B digital device

Dimension Drawing

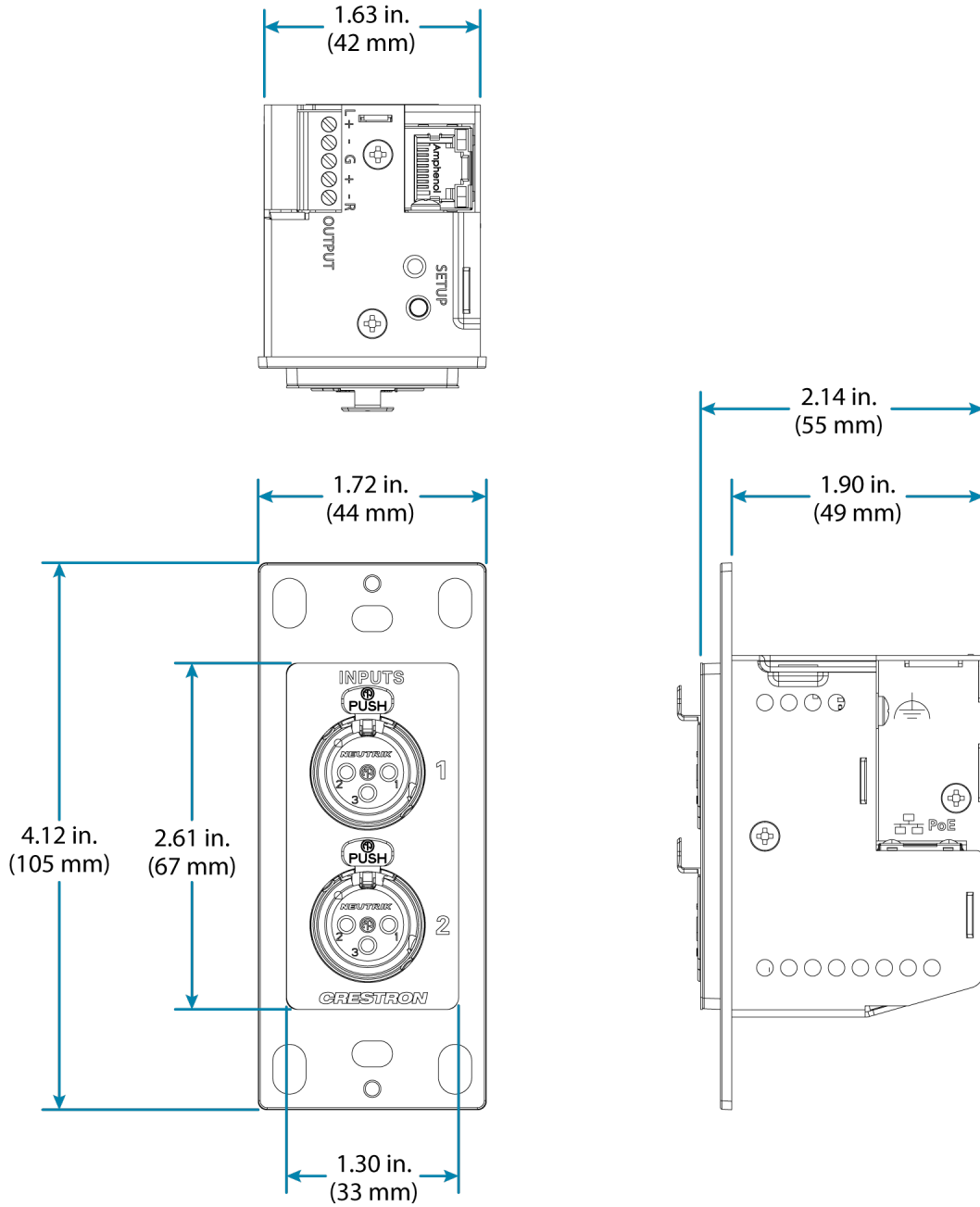

DM-NAX-8ZSA Specifications

Product specifications for the DM-NAX-8ZSA are provided below.

Specifications

Audio

Input Signal Types	4 stereo analog (RCA); 4 digital S/PDIF (2 TOSLINK® and 2 Coaxial)
Output Signal Types	4 stereo analog outputs (mirrors speaker zone outputs 1-4), Outputs 1 and 2 have a balanced 5-pin stereo Phoenix connection and an unbalanced RCA connection
Sampling Rates and Bit Depths	Digital Input (Coaxial): Up to 192 kHz, 24-bit; Digital Input (Optical): Up to 96 kHz, 24-bit; Media Players: Up to 192 kHz, 24-bit
Source Compensation	±10.0 dB per input
Input Monitoring	Source Signal Detect
Output Power	150 Watts per channel at 8 Ohms; 300 Watts per channel at 4 Ohms; 500 Watts per channel at 8 Ohms bridged
Amplifier Monitoring	Over Current, Over/Under Voltage, Over Temperature, DC Offset, Clipping
Frequency Response	20 Hz to 20 kHz ±0.6 dB
THD	0.006%
S/N Ratio	110 dB digital in, 108 dB analog in
Stereo Separation	85 dB @ 1 kHz, 8 ohm; 80 dB @ 1 kHz, 4 ohm
Zone Separation	100 dB @ 1 kHz, 8 ohm; 95 dB @ 1 kHz, 4 ohm
Zone Volume Level Control	-80.0 to +20.0 dB, adjustable from 0% to 100% plus mute
Bass Control	±12.0 dB
Treble Control	±12.0 dB
Loudness Compensation	On/Off
Dynamic Range Control	Off/Low/Medium/High
Balance Control	Left/right adjustable
Zone Configuration	Stereo Single Ended, Mono Single Ended, Stereo Bridged, Mono Bridged, Bridged 2.1, and Bridged 2.1 with Bridged Sub
Power Limiting	Configurable 5 to 150 Watts @ 8 Ohms; 5 to 300 Watts @ 4 Ohms; 5 to 500 Watts @ 8 Ohms bridged
Tone Profiles	Flat, Classical, Jazz, Pop, Rock, Spoken Word

EQ Filter Types	EQ, High Pass, Low Pass, Treble Shelf, Bass Shelf, Notch
EQ Center Frequency	10 to 20,000 Hz per band
EQ Gain	+20/-40 dB per band
EQ Bandwidth	0.1 to 4.0 octaves per band
Bus Volume Offset	±12.0 dB per zone for output bussing

Communications

Ethernet	For control, AoIP, and or console, 100/1000 Mbps, auto-switching, auto-negotiating, auto-discovery, full/half duplex, DHCP
USB	For configuration management

Connectors

SPDIF SOURCES 1 – 2	(2) JIS F05 female (TOSLINK) optical fiber connector; S/PDIF optical digital audio input
SPDIF SOURCES 3 – 4	(2) RCA female; S/PDIF coaxial digital audio inputs; Input Impedance: 75 Ohms
ANALOG SOURCES L/R 5 – 8	(8) RCA female comprising (4) unbalanced stereo line-level audio inputs; Input Impedance: 10k Ohms; Maximum Input Level: 2 Vrms
ANALOG OUT L/R 1 – 4	(8) RCA connectors, female; Comprises (4) unbalanced line-level stereo audio outputs (mirror corresponding amplified output pairs 1 – 4); Output Impedance: 100 Ohms; Maximum Output Level: 2 Vrms
ANALOG OUT L/R 1 – 2	(2) 5-pin 3.5mm detachable terminal blocks; Balanced stereo line-level audio outputs (mirror corresponding unbalanced output pairs 1 – 2); Output Impedance: 150 Ohms; Maximum Output Level: 4 Vrms
I/O 1-4	(1) 5-pin 3.5 mm detachable terminal block; Comprises (4) Versiport digital input/output or analog input ports (referenced to G); Digital Input: Rated for 0-24VDC, input impedance 20 kΩ, logic threshold >3.125V low/0 and <1.875V high/1; Digital Output: 250mA sink from maximum 24VDC, catch diodes for use with real world loads; Analog Input: Rated for 0-10VDC, protected to 24VDC maximum, input impedance 21 kΩ with pull-up resistor disabled; Programmable 5V, 2 kΩ pull-up resistor per pin
TRIGGER 1-4	(2) 4-pin 3.5 mm detachable terminal block; Comprises (4) voltage triggers to turn on a connected external amplifier; Outputs +12VDC @ 50mA for as long as an audio output signal is detected on the corresponding ANALOG OUT
Ethernet 1	(1) 8-wire RJ45 female; 100Base-T/1000Base-TX Ethernet port
Ethernet 2	(1) 8-wire RJ45 female; 100Base-T/1000Base-TX Ethernet port

USB	(1) USB Type B connector, female; USB computer console port (cable included); For setup only
100-240V~50/60Hz Universal AC	(1) IEC 60320 C14 main power inlet, mates with removable power cord (included)
G	6-32 screw, chassis ground lug
SPEAKER OUTPUTS L/R 1 – 8	(16) 2-pin 7.62mm 15A detachable terminal blocks; Power amplifier outputs; Wire Size: Terminals accept up to 12AWG

Controls and Indicators

PWR	(1) LED. Amber indicates that the device is booting. White indicates that the device is switched on with audio passing. Red indicates that the device is in standby mode. Off indicates that there is no power from the power supply.
LAN	(1) LED. White indicates that the device is switched on and has a valid IP address. Off indicates that the device is not connected to a network or the IP address is invalid.
NAX	(1) LED. White indicates that AoIP is ready to pass and the unit's PTP clock is synced. Off indicates that no AoIP is passing to or from and/or PTP is not synced.
SOURCE 1-8	(8) LEDs. White indicates signal presence on the specified input/source. Red indicates there is a clipping on an analog input or a bitstream issue on a digital input. Off indicates that there is no signal detected on the specified input/source.
ZONE 1-8	(8) LEDs. White indicates there is audio output on the indicated zone. Red indicates a fault due to clipping, over current, over temperature, or low voltage.
SETUP	(1) LED. Blinking red indicates that a network reset or factory restore has been initiated via the adjacent SETUP button.

Power

Power Consumption	240 W (All channels driven at 1/8th power, 8 ohms)
--------------------------	-------------------------------------------------------

Environmental

Temperature	32° to 104°F (0° to 40°C)
Humidity	10% to 90% RH (non-condensing)
Heat Dissipation	450 BTU/hr

Construction

Chassis	Metal, black and silver finish, vented sides
Mounting	2 RU rack-mountable

Dimensions

Height	3.50 in. (89 mm)
Width	19 in. (482 mm) 17.28 in. (439 mm) without rack ears
Depth	14.52 in. (369 mm)

Weight

28 lb (12.70 kg)

Compliance

Regulatory Model: M1845004

FCC Part 15 Class B digital device, IC Class B, CE, ETL listed

Dimension Drawing

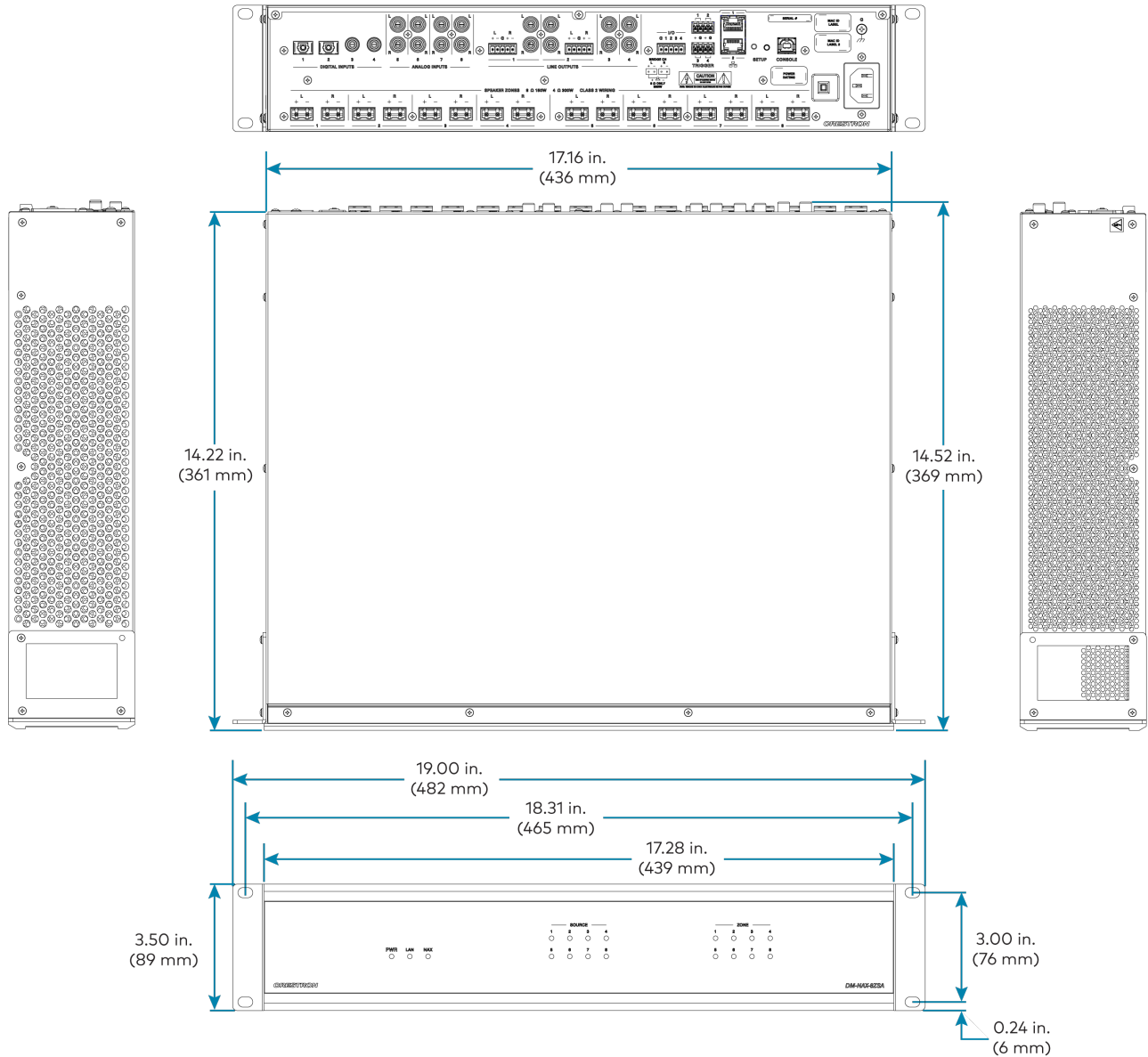

DM-NAX-4ZSA-50 Specifications

Product specifications for the DM-NAX-4ZSA-50 are provided below.

Specifications

Audio

Input Signal Types	2 stereo analog (RCA); 2 digital S/PDIF (1 TOSLINK® connection and 1 coaxial connection, PCM only)
Output Signal Types	4 stereo speaker-level amplified outputs; 1 stereo analog line-level output
Sampling Rates and Bit Depths	Digital Input (Coaxial): Up to 192 kHz, 24-bit; Digital Input (Optical): Up to 192 kHz, 24-bit; Media Players: Up to 192 kHz, 24-bit
Source Compensation	±10.0 dB per input
Input Monitoring	Source Signal Detect
Output Power	50 W per channel at 4 Ω or 8 Ω
Amplifier Monitoring	Over Current, Over/Under Voltage, Over Temperature, DC Offset, Clipping
Frequency Response	20 Hz to 20 kHz ±0.5 dB
THD	0.006%
S/N Ratio	110 dB digital in; 108 dB analog in
Stereo Separation	95 dB @ 1 kHz, 8 Ohm; 90 dB @ 1 kHz, 4 Ohm
Zone Separation	100 dB @ 1 kHz, 8 Ohm; 95 dB @ 1 kHz, 4 Ohm
Zone Volume Level Control	-80.0 to +20.0 dB, adjustable from 0% to 100% plus mute
Bass Control	±12.0 dB
Treble Control	±12.0 dB
Loudness Compensation	On/Off
Dynamic Range Control	Off/Low/Medium/High
Balance Control	Left/right adjustable
Zone Configuration	Stereo Single Ended; Mono Single Ended
Power Limiting	Configurable 5 to 50 W @ 4 Ω or 8 Ω
Tone Profiles	Flat, Classical, Jazz, Pop, Rock, Spoken Word
EQ Filter Types	EQ, High Pass, Low Pass, Treble Shelf, Bass Shelf, Notch
EQ Center Frequency	10 Hz to 20 kHz per band
EQ Gain	-40.0 to +20.0 dB per band
EQ Bandwidth	0.1 to 4.0 octaves per band
Bus Volume Offset	±12.0 dB per zone for output bussing

Communications

Ethernet	For control, AoIP, and/or console; 100/1000 Mbps, auto-switching, auto-negotiating, auto-discovery, full/half duplex, DHCP
-----------------	-------------------------------------------------------------------------------------------------------------------------------

Connectors

SPEAKER ZONES 1-4	(4) 4-pin 5.08 mm detachable terminal blocks; Stereo speaker-level audio outputs; Maximum Wire Size: 12 AWG
LINE OUT 5	(2) RCA female comprising (1) unbalanced stereo line-level audio output; Output Impedance: 100 Ω ; Maximum Output Level: 2Vrms
DIGITAL INPUT 1	(1) RCA female; S/PDIF coaxial digital audio input; Input Impedance: 75 Ω
DIGITAL INPUT 2	(1) JIS F05 female TOSLINK® optical fiber connector; S/PDIF optical digital audio input
ANALOG INPUTS 3-4	(4) RCA female comprising (2) unbalanced stereo line-level audio inputs; Input Impedance: 10 k Ω ; Maximum Input Level: 2Vrms
ETHERNET 1-2	(2) 8-pin RJ-45 connectors, female; 100BASE-TX/1000BASE-T Ethernet port; Green LED indicates Ethernet link status; Flashing amber LED indicates Ethernet activity
100-240 VAC 1.0-0.4A 50/60HZ	(1) 100-240V~50/60Hz Universal AC; IEC 60320 C14 main power inlet, mates with removable power cord (included)

Controls and Indicators

PWR	(1) LED; Amber indicates that the device is booting; White indicates that the device is switched on with audio passing; Red indicates that the device is in standby mode
LAN	(1) White LED; Indicates that the device has a valid IP address
NAX	(1) White LED; White indicates that audio-over-IP traffic is passing in or out of the DM NAX unit
SOURCE 1-4	(4) LEDs; White indicates signal presence on the specified input/source; Red indicates there is clipping on the specified input/source
ZONE 1-5	(5) LEDs; White indicates there is audio output on the indicated zone; Red indicates a fault due to clipping, over current, over temperature, or low voltage

SETUP

(1) Push button: Pressing and holding the **SETUP** button for 15 seconds with power supplied clears network settings and restores the default DHCP mode;
To perform a factory restore, press and hold the **SETUP** button with power disconnected, then connect the power supply and continue to hold the **SETUP** button for 30 seconds;
(1) LED, illuminates red when the button is pressed, flashes red when reset has been initiated

Power

Main Power	1.0-0.4A @ 100-240VAC, 50/60 Hz
Power Consumption	50 W (all channels driven at 1/8 output power, 8 Ω)

Environmental

Temperature	32° to 104°F (0° to 40°C)
Humidity	10% to 90% RH (non-condensing)
Heat Dissipation	85 BTU/hr (all channels driven at 1/8 output power, 4 Ω)

Construction

Chassis	Metal, black and silver finish, vented front and rear panels
Mounting	1 RU rack-mountable

Dimensions

Height	1.72 in. (44 mm)
Width	8.66 in. (220 mm)
Depth	10.97 in. (279 mm)

Weight

4.15 lb (1.88 kg)

Compliance

Regulatory Model: M1845004

Intertek® Listed for US & Canada, CE, IC, FCC Part 15 Class B digital device

Dimension Drawing

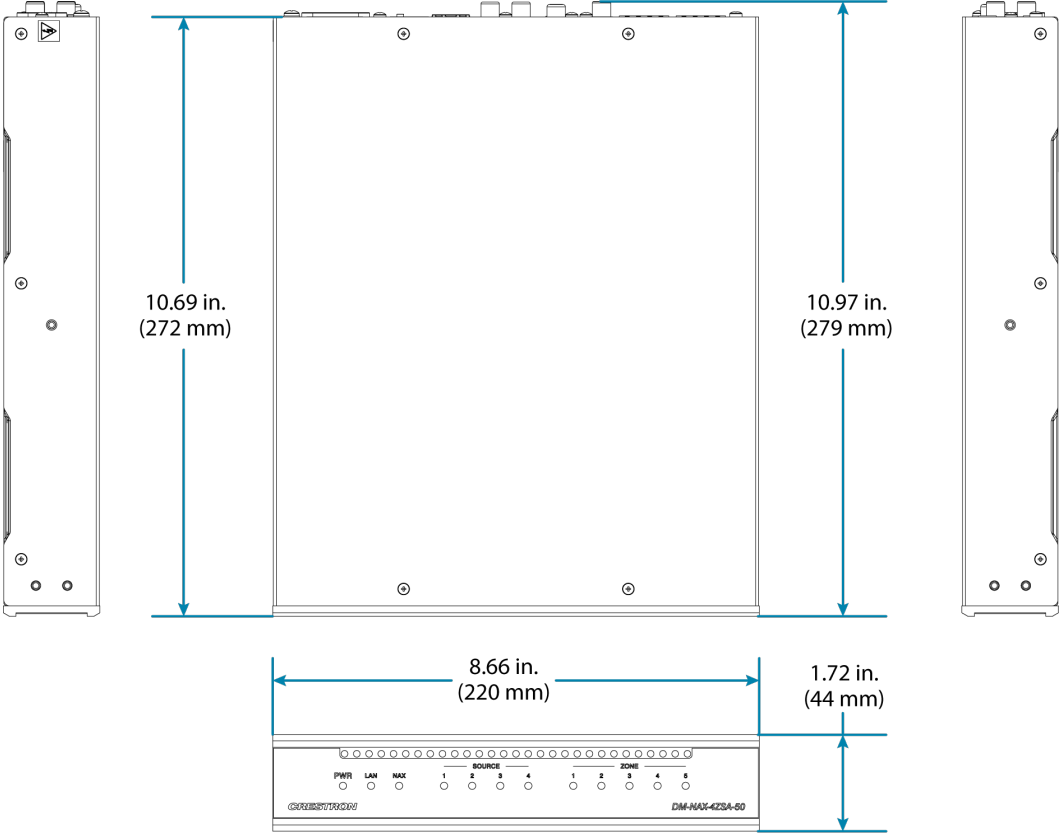

DM-NAX-4ZSP Specifications

Product specifications for the DM-NAX-4ZSP are provided below.

Specifications

Audio

Input Signal Types	4 stereo analog (RCA); 4 digital S/PDIF (2 TOSLINK® and 2 Coaxial)
Output Signal Types	4 stereo analog outputs, Outputs 1 and 2 have a balanced 5-pin stereo Phoenix connection and an unbalanced RCA connection
Sampling Rates and Bit Depths	Digital Input (Coaxial): Up to 192 kHz, 24-bit; Digital Input (Optical): Up to 96 kHz, 24-bit; Media Players: Up to 192 kHz, 24-bit
Source Compensation	±10.0 dB per input
Input Monitoring	Source Signal Detect
Frequency Response	20 Hz to 20 kHz ±0.2 dB
THD	0.006%
S/N Ratio	110 dB digital in, 108 dB analog in
Zone Volume Level Control	-80.0 to +20.0 dB, adjustable from 0% to 100% plus mute
Bass Control	±12.0 dB
Treble Control	±12.0 dB
Loudness Compensation	On/Off
Dynamic Range Control	Off/Low/Medium/High
Balance Control	Left/right adjustable
Tone Profiles	Flat, Classical, Jazz, Pop, Rock, Spoken Word
EQ Filter Types	EQ, High Pass, Low Pass, Treble Shelf, Bass Shelf, Notch
EQ Center Frequency	10 to 20,000 Hz per band
EQ Gain	+20/-40 dB per band
EQ Bandwidth	0.1 to 4.0 octaves per band
Bus Volume Offset	±12.0 dB per zone for output bussing

Communications

Ethernet	For control, AoIP, and or console, 100/1000 Mbps, auto-switching, auto-negotiating, auto-discovery, full/half duplex, DHCP
USB	For configuration management

Connectors

SPDIF SOURCES 1 – 2	(2) JIS F05 female (TOSLINK) optical fiber connector; S/PDIF optical digital audio input
SPDIF SOURCES 3 – 4	(2) RCA female; S/PDIF coaxial digital audio inputs; Input Impedance: 75 Ohms
ANALOG SOURCES L/R 5 – 8	(8) RCA female comprising (4) unbalanced stereo line-level audio inputs; Input Impedance: 10k Ohms; Maximum Input Level: 2 Vrms
ANALOG OUT L/R 1 – 4	(8) RCA connectors, female; Comprises (4) unbalanced line-level stereo audio outputs (mirror corresponding amplified output pairs 1 – 4); Output Impedance: 100 Ohms; Maximum Output Level: 2 Vrms
ANALOG OUT L/R 1 – 2	(2) 5-pin 3.5mm detachable terminal blocks; Balanced stereo line-level audio outputs (mirror corresponding unbalanced output pairs 1 – 2); Output Impedance: 150 Ohms; Maximum Output Level: 4 Vrms
I/O 1-4	(1) 5-pin 3.5 mm detachable terminal block; Comprises (4) Versiport digital input/output or analog input ports (referenced to G); Digital Input: Rated for 0-24VDC, input impedance 20 k Ω , logic threshold >3.125V low/0 and <1.875V high/1; Digital Output: 250mA sink from maximum 24VDC, catch diodes for use with real world loads; Analog Input: Rated for 0-10VDC, protected to 24VDC maximum, input impedance 21 k Ω with pull-up resistor disabled; Programmable 5V, 2 k Ω pull-up resistor per pin
TRIGGER 1-4	(2) 4-pin 3.5 mm detachable terminal block; Comprises (4) voltage triggers to turn on a connected external amplifier; Outputs +12VDC @ 50mA for as long as an audio output signal is detected on the corresponding ANALOG OUT
Ethernet 1	(1) 8-wire RJ45 female; 100Base-T/1000Base-TX Ethernet port
Ethernet 2	(1) 8-wire RJ45 female; 100Base-T/1000Base-TX Ethernet port
USB	(1) USB Type B connector, female; USB computer console port (cable included); For setup only
100-240V~50/60Hz Universal AC	(1) IEC 60320 C14 main power inlet, mates with removable power cord (included)

G 6-32 screw, chassis ground lug

Controls and Indicators

PWR	(1) LED. White indicates that the device is switched on with audio passing. Red indicates that the device is in standby mode. Off indicates that there is no power from the power supply.
LAN	(1) LED. White indicates that the device is switched on and has a valid IP address. Off indicates that the device is not connected to a network or the IP address is invalid.
NAX	(1) LED. White indicates that AoIP is ready to pass and the unit's PTP clock is synced. Off indicates that no AoIP is passing to or from and/or PTP is not synced.
SOURCE 1-8	(8) LEDs. White indicates signal presence on the specified input/source. Red indicates there is a clipping on an analog input or a bitstream issue on a digital input. Off indicates that there is no signal detected on the specified input/source.
ZONE 1-4	(4) LEDs. White indicates there is audio output on the indicated zone. Red indicates clipping is detected on the output audio.
SETUP	(1) LED. Blinking red indicates that a network reset or factory restore has been initiated via the adjacent SETUP button.

Power

Power Consumption 15.9 W

Environmental

Temperature	32° to 104°F (0° to 40°C)
Humidity	10% to 90% RH (non-condensing)
Heat Dissipation	57 BTU/hr

Construction

Chassis	Metal, black and silver finish, vented sides
Mounting	1 RU rack-mountable

Dimensions

Height	1.73 in. (44 mm)
Width	19 in. (482 mm) 17.28 in. (439 mm) without rack ears
Depth	14.50 in. (368 mm)

Weight

8.06 lb (3.65 kg)

Compliance

Regulatory Model: M1845004

FCC Part 15 Class B digital device, IC Class B, CE, ETL listed

Dimension Drawing

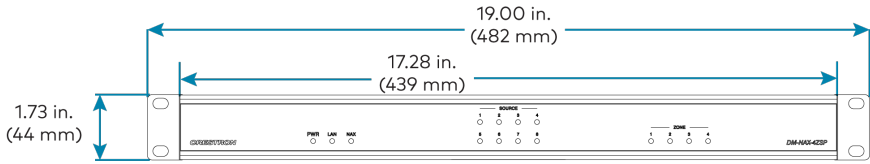
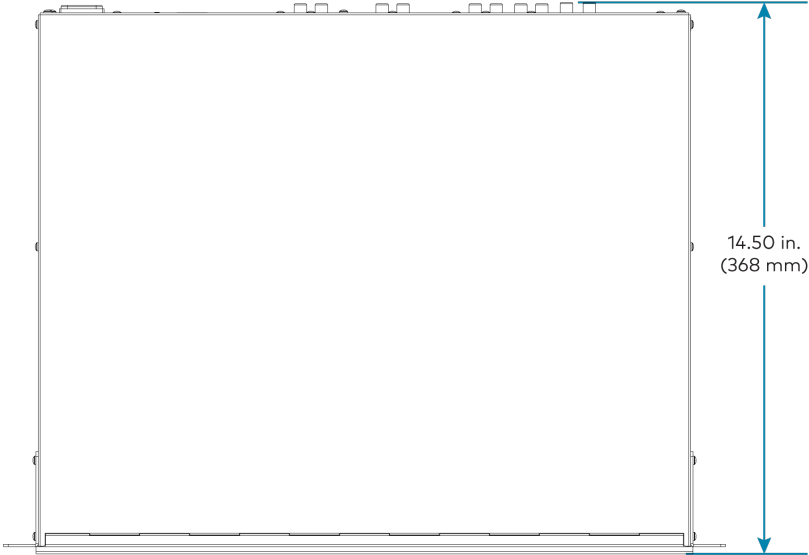

DM-NAX-16AIN Specifications

Product specifications for the DM-NAX-16AIN are provided below.

Specifications

Audio

Input Signal Types	8 stereo unbalanced analog (RCA) includes (4) 5-pin phoenix balanced connector; 8 digital SPDIF (4 TOSLINK® and 4 Coaxial)
Source Compensation	±10.0 dB per input
Input Monitoring	Source Signal Detect
THD	0.002%
S/N Ratio	110 dB digital in, 108 dB analog in
Frequency Response	20 Hz to 20 kHz (±0.6 dB)
Supported Sample Rates	Coaxial: Up to 192 kHz; Optical: 192 kHz

Communications

Ethernet	For control, AoIP, and or console, 100/1000 Mbps, auto-switching, auto-negotiating, auto-discovery, full/half duplex, DHCP
USB	For configuration management

Connectors

ANALOG SOURCES L/R 1 – 8	(8) RCA female comprising (4) unbalanced stereo line-level audio inputs; (4) 5-pin phoenix balanced connector Input Impedance: 10 k Ω ; Maximum Input Level: 2 V _{rms}
SPDIF SOURCES 9 – 12	(4) JIS F05 female (TOSLINK) optical fiber connector; S/PDIF optical digital audio input
SPDIF SOURCES 13 – 16	(4) RCA female; S/PDIF coaxial digital audio inputs; Input Impedance: 75 Ω
Ethernet 1	(1) 8-wire RJ45 female; 100Base-T/1000Base-TX Ethernet port
Ethernet 2	(1) 8-wire RJ45 female; 100Base-T/1000Base-TX Ethernet port
USB	(1) USB Type B connector, female; USB computer console port (cable included); For setup only
100-240V~50/60Hz Universal AC	(1) IEC 60320 C14 main power inlet, mates with removable power cord (included)
G	6-32 screw, chassis ground lug

Controls and Indicators

PWR	(1) LED. Amber indicates that the device is booting. White indicates that the device is switched on with audio passing. Red indicates that the device is in standby mode. Off indicates that there is no power from the power supply.
LAN	(1) LED. White indicates that the device is switched on and has a valid IP address. Off indicates that the device is not connected to a network or the IP address is invalid.
NAX	(1) LED. White indicates that AoIP is ready to pass and the unit's PTP clock is synced. Off indicates that no AoIP is passing to or from and/or PTP is not synced.
SOURCE 1-16	(16) LEDs. White indicates signal presence on the specified input/source. Red indicates there is a clipping on an analog input or a bitstream issue on a digital input. Off indicates that there is no signal detected on the specified input/source.
SETUP	(1) LED. Blinking red indicates that a network reset or factory restore has been initiated via the adjacent SETUP button.

Power

Power Consumption	20 Watts
--------------------------	----------

Environmental

Temperature	32° to 104°F (0° to 40°C)
Humidity	10% to 90% RH (non-condensing)
Heat Dissipation	70 BTU/hr

Construction

Chassis	Metal, black and silver finish, vented sides
Mounting	1 RU rack-mountable

Dimensions

Height	1.25 in. (32 mm)
Width	19 in. (483 mm); 17.28 in. (439 mm) without rack ears
Depth	14.46 in. (368 mm)

Weight

7.39 lb (3.35 kg)

Compliance

Regulatory Model: M1845004

FCC Part 15 Class B digital device, CE, ETL listed

Dimension Drawing

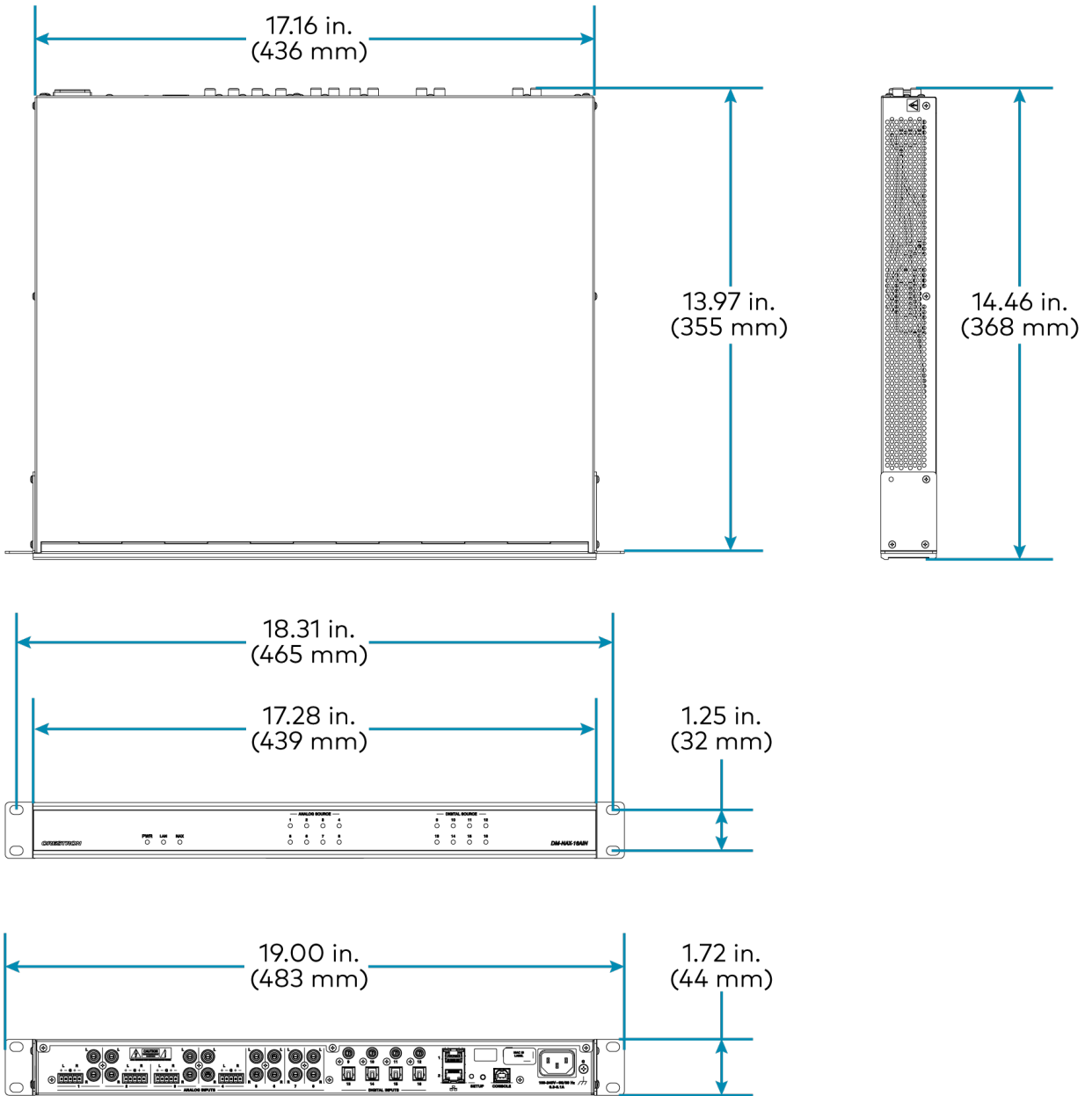

DM-NAX-AMP-X300 Specifications

Product specifications for the DM-NAX-AMP-X300 are provided below.

Specifications

Audio

Input Signal Types	Balanced/unbalanced analog line/mic-level and AoIP streams.
Balanced Analog Input	Maximum signal level: +21 dBu (8.7Vrms) Impedance: >10 k Ω <i>f</i> Response: 20 Hz to 20 kHz \pm 0.5 dB THD+N: <0.005% @ 1 kHz S/N Ratio: 105 dB A-weight Channel Separation: 100 dB @ 1 kHz
Mic Input	Maximum gain: 60 dB Impedance: >10 k Ω <i>f</i> Response: 20 Hz to 20 kHz \pm 0.5 dB THD+N: <0.005% @ 1 kHz @ 60 dB gain S/N Ratio: 71 dB @ 60 dB gain A-weight Channel Separation: 69 dB @ 60 dB gain @ 1 kHz
Balanced Analog Output	Maximum signal level: +21 dBu (8.7Vrms) Impedance: 200 Ω <i>f</i> Response: 20 Hz to 20 kHz \pm 0.5 dB THD+N: 0.005% @ 1 kHz at max output S/N Ratio: 113 dB digital in, 105 dB analog in, 20 Hz -20 kHz, A-weight Channel Separation: 100 dB @ 1 kHz
Speaker Output	<i>f</i> Response: 20 Hz to 20 kHz \pm 0.5 dB at 1 W High-Pass Filter (70V and 100V operation only): -3 dB @ 80 Hz, -12 dB/octave THD+N: <0.1% at 1 kHz @ -3 dB full rated output power S/N Ratio: >103 dB, 20 Hz to 20 kHz, balanced Crosstalk: -75 dB at 1 kHz Gain: 29 dB @ 8 Ω Protection: Over current, under voltage, over temperature, DC offset, extreme high frequency Go to Sleep Time: 25 minutes with no signal present (when set to POWER SAVER) Wake Time: 0.5 s typical

Output Power Per Channel

Mode	1 Channel Driven	2 Channels Driven	3 Channels Driven	4 Channels Driven
Lo-Z, 8 Ω (single ended)	150 W	150 W	75 W ¹	75 W
Lo-Z, 4 Ω (single ended)	200 W	150 W	75 W ¹	75 W
Lo-Z, 8 Ω Bridged	300 W	150 W	150 W ¹	N/A
Hi-Z 70V	300 W	150 W	N/A	N/A
Hi-Z 100V	300 W	150 W	N/A	N/A

NOTES:

- Total output power from all channels combined (simultaneously) is up to 300 W.
- Each mode will output power in watts up to the value listed in the table.

Connectors

CH1-CH4 (2) 4-pin 5.08 mm pitch, 12A plug with screw locking retainers;
Power amplifier output;
Terminals accept up to 12 AWG (3.31 mm)

NOTE: Output is direct-coupled, not transformer isolated.

IN1-IN4 (4) 3-pin 3.5 mm detachable terminal block;
Balanced/unbalanced line or mic-level audio inputs;
Maximum Input Level: 8.7V_{rms}, +21 dBu;
Input Impedance: 10 k Ω Wake threshold is -65 dBu;
Phantom power is available when used as mic-level inputs

OUT1-OUT4 (4) 3-pin 3.5 mm detachable terminal block;
Balanced/unbalanced line-level audio outputs;
Maximum Output Level: 8.7V_{rms}, +21 dBu

REMOTE (1) 2-pin 3.5 mm detachable terminal block;
Connect to dry contact closure to place amplifier in standby mode

G (1) 6-32 screw;
Chassis ground lug

100-240V~ 1.2-0.6A 50/60 Hz (1) IEC 60320 C14 main power inlet;
Mates with removable power cord, included

Ethernet 1 (1) 8-wire RJ45 female;
100Base-T/1000Base-TX Ethernet port

Ethernet 2 (1) 8-wire RJ45 female;
100Base-T/1000Base-TX Ethernet port

Controls and Indicators

PWR (1) LED;
White indicates amplifier is on and ready for use;
Amber indicates the amplifier is booting;
Red indicates amplifier is in standby

HI-Z	(1) White LED; Indicates when Hi-Z mode is enabled (70V or 100V)
LAN	(1) White LED; Indicates that the device has a valid IP address
AoIP	(1) White LED; Indicates an active AoIP stream
FAULT	(4) Red LEDs (one per speaker output); Indicates that the input channel has a fault or is clipping
SIGNAL	(4) White LEDs (one per speaker output); Indicates an active input signal
LOCKOUT	(1) Red LED; Indicates that rear panel slide switches are being overridden by programmatic or web UI control
Lo-Z MODES	(2) Slide switches, one switch controlling channels 1 and 2, and one switch controlling channels 3 and 4; Selects stereo, summed, or bridged operation: <ul style="list-style-type: none"> • STEREO: The input signal received on each channel is sent to its respectively numbered speaker, line, and network output for use in applications where left and right channel separation is required. • SUM: The input signals received on a pair of line inputs (1 + 2 or 3 + 4) are each routed to both channels of their respectively numbered speaker, line, and network output pair. • BRIDGE: The input signals received on a pair of line inputs (1 + 2 or 3 + 4) are summed and sent to a bridged output (1 + 2 or 3 + 4) for use in high power applications.
Operations Mode	(1) Slide switch; Sets the amplifier for Lo-Z (4 or 8 Ω) or Hi-Z operation (70V or 100V)
Power Mode	(1) Slide switch; Selects Power Saver or Always On operation
SETUP	(1) Red LED and push button; Utilized in some restore procedures

Power

Main Power	1.2-0.6A @ 100-240VAC, 50/60 Hz
Power Consumption	75 W (All channels driven at 1/8th power, 8 Ω)

Environmental

Temperature	41 to 104°F (5° to 40°C)
Humidity	10% to 90% RH (non-condensing)
Heat Dissipation	130 BTU/hr

Dimensions

Height	1.74 in. (44 mm)
Width	9.38 in. (238 mm)

Depth 11.03 in. (280 mm)

Weight

5.3 lb (2.4 kg)

Compliance

Regulatory Model: M1845004

UL® Listed for US & Canada, CE, IC, FCC Part 15 Class B digital device

Note:

1. 3 channel operation requires two single ended loads and one bridged load.

Dimension Drawings

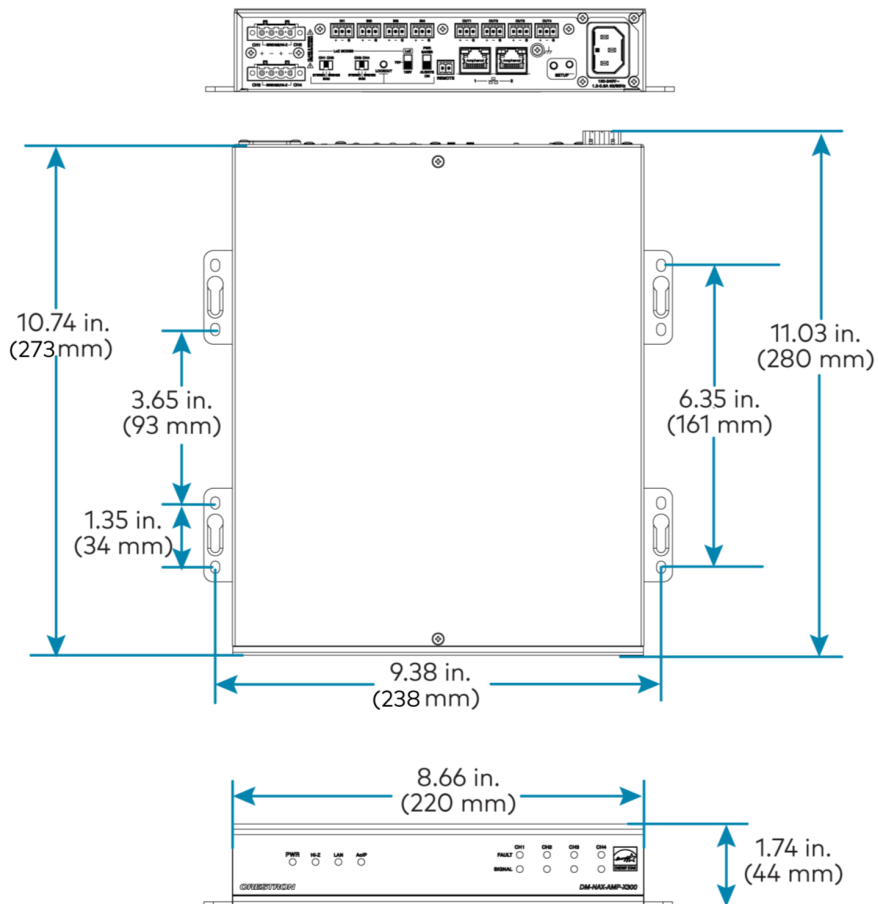

DM-NAX-AUD-IO Specifications

Product specifications for the DM-NAX-AUD-IO are provided below.

Specifications

Audio

Input Signal Types	Balanced/unbalanced stereo analog line-level; DM NAX/AES67 audio-over-IP
Output Signal Types	Balanced/unbalanced stereo analog line-level; DM NAX/AES67 audio-over-IP
Source Compensation	±10.0 dB per input
Input Monitoring	Source Signal Detect
Frequency Response (at line-level output)	20 Hz to 20 kHz ±0.5 dB
THD+N (at line-level output)	0.005% @ 1 kHz, max output
S/N Ratio (at line-level output)	From line-level input: 110 dB, 20 Hz to 20 kHz, A-weighted; From digital input: 113 dB, 20 Hz to 20 kHz, A-weighted
Balance Control	Left/right adjustable
EQ Filter Types	EQ, High Pass, Low Pass, Treble Shelf, Bass Shelf, Notch
EQ Center Frequency	10 to 20,000 Hz per band
EQ Gain	+20/-40 dB per band
EQ Bandwidth	0.1 to 4.0 octaves per band

Communications

Ethernet	For control and PoE, AoIP, and/or console, 100/1000 Mbps, auto-switching, auto-negotiating, auto-discovery, full/half duplex, DHCP
-----------------	------------------------------------------------------------------------------------------------------------------------------------

Connectors

INPUTS	(1) 5-pin 3.5 mm detachable terminal block; Balanced/unbalanced line-level audio inputs; Maximum Input Level: +21 dBu (8.7Vrms); Input Impedance: 10 k Ω
OUTPUTS	(1) 5-pin 3.5 mm detachable terminal block; Balanced/unbalanced line-level audio outputs; Maximum Output Level: +21 dBu (8.7Vrms); Channel separation: 100 dB @ 1 kHz; Output Impedance: 400 Ω
G	(1) 6-32 screw; Chassis ground lug

ETHERNET PoE (1) 8-pin RJ-45 connector, female;
100BASE-TX/1000BASE-T Ethernet port;

Controls and Indicators

ETHERNET PoE Left amber LED indicates 1000 Mb link status;
Left green LED indicates 100 Mb link status;
Flashing right amber LED indicates Ethernet activity

SETUP (1) Push button: Used for factory reset procedures;
(1) LED, illuminates red when the button is pressed, flashes red when reset has been initiated

Power

PoE IEEE 802.3af Class 0 (12.95 W) compliant;
Compatible with IEEE 802.3af compliant Ethernet switch or third-party PoE compliant PSE

Power Consumption 5 W

Environmental

Temperature 32° to 104° F (0° to 40° C)

Humidity 10% to 95% RH (noncondensing)

Heat Dissipation 17 BTU/hr

Construction

Chassis Metal, black and silver finish

Mounting Mountable on the following via included hardware:
1-gang U.S. electrical box or plaster ring (not included), 3.5 in. (26 mm) electrical box depth recommended;
Rack rail;
Surface mount

Dimensions

Height 1.59 in. (41 mm)

Width 2.60 in. (66 mm)

Depth 2.11 in. (54 mm)

Weight

7 oz. (199 g)

Compliance

Regulatory Model: M1845004
IC, FCC Part 15 Class B digital device

Dimension Drawing

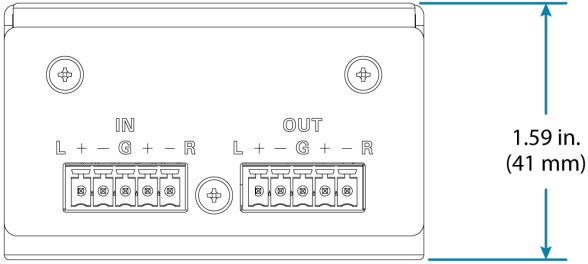
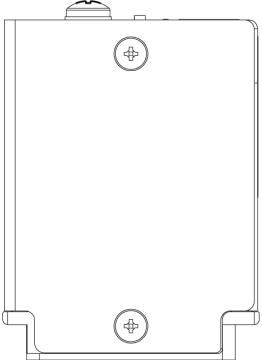
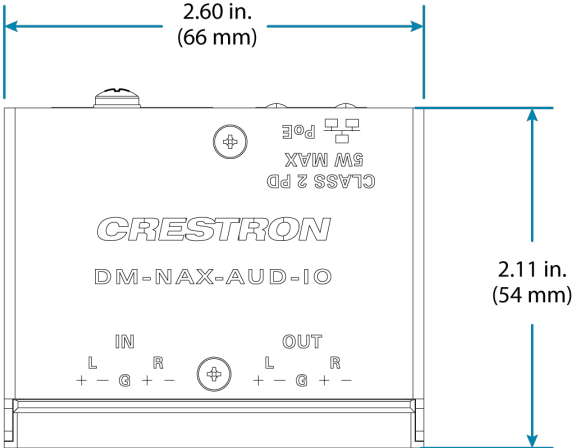

DM-NAX-AUD-USB Specifications

Product specifications for the DM-NAX-AUD-USB are provided below.

Specifications

Audio

Input Signal Types	USB stereo; Unbalanced stereo analog line-level; DM NAX/AES67 audio-over-IP
Output Signal Types	USB stereo; Unbalanced stereo analog line-level; DM NAX/AES67 audio-over-IP
Source Compensation	±10.0 dB per input
Input Monitoring	Source Signal Detect
Frequency Response (at line-level output)	20 Hz to 20 kHz ±0.5 dB
THD+N (at line-level output)	0.005% @ 1 kHz, max output
S/N Ratio (at line-level output)	From line-level input: 108 dB, 20 Hz to 20 kHz, A-weighted; From digital input: 111 dB, 20 Hz to 20 kHz, A-weighted
Balance Control	Left/right adjustable
EQ Filter Types	EQ, High Pass, Low Pass, Treble Shelf, Bass Shelf, Notch
EQ Center Frequency	10 to 20,000 Hz per band
EQ Gain	+20/-40 dB per band
EQ Bandwidth	0.1 to 4.0 octaves per band

Communications

Ethernet	For control and PoE, AoIP, and/or console, 100/1000 Mbps, auto-switching, auto-negotiating, auto-discovery, full/half duplex, DHCP
USB	Bidirectional USB Audio Class 1 (UAC1) device connection, up to 24-bit/48 kHz stereo audio transfer

Connectors

USB	(1) USB Type-C connector, female; UAC1 audio support; Enumerates as a Non-AEC Enabled Speakerphone
INPUT	(1) 1/8 in. 3.5 mm connector, female TRS; Unbalanced line-level audio input; Maximum input level: 2V _{rms} ; Input Impedance: 10 kΩ

OUTPUT	(1) 1/8 in. 3.5 mm connector, female TRS; Unbalanced line-level audio output; Maximum output level: 2Vrms; Channel separation: 100 dB @ 1 kHz; Output impedance: 100 Ω
G	(1) 6-32 screw; Chassis ground lug
ETHERNET PoE	(1) 8-pin RJ-45 connector, female; 100BASE-TX/1000BASE-T Ethernet port

Controls and Indicators

ETHERNET PoE	Left amber LED indicates 1000 Mb link status; Left green LED indicates 100 Mb link status; Flashing right amber LED indicates Ethernet activity
SETUP	(1) Push button: Used for factory reset procedures; (1) LED, illuminates red when the button is pressed, flashes red when reset has been initiated

Power

PoE	IEEE 802.3af Class 0 (12.95 W) compliant; Compatible with IEEE 802.3af compliant Ethernet switch or third-party PoE compliant PSE
Power Consumption	5 W

Environmental

Temperature	32° to 104° F (0° to 40° C)
Humidity	10% to 95% RH (noncondensing)
Heat Dissipation	17 BTU/hr

Construction

Chassis	Metal, black and silver finish
Mounting	Mountable on the following via included hardware: 1-gang U.S. electrical box or plaster ring (not included), 3.5 in. (26 mm) electrical box depth recommended; Rack rail; Surface mount

Dimensions

Height	1.59 in. (41 mm)
Width	2.60 in. (66 mm)
Depth	2.11 in. (54 mm)

Weight

7 oz. (199 g)

Compliance

Regulatory Model: M1845004

IC, FCC Part 15 Class B digital device

Dimension Drawing

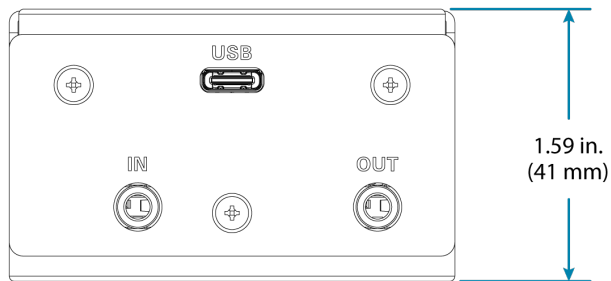
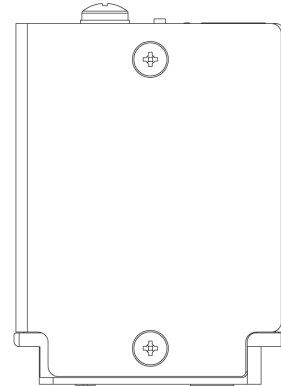
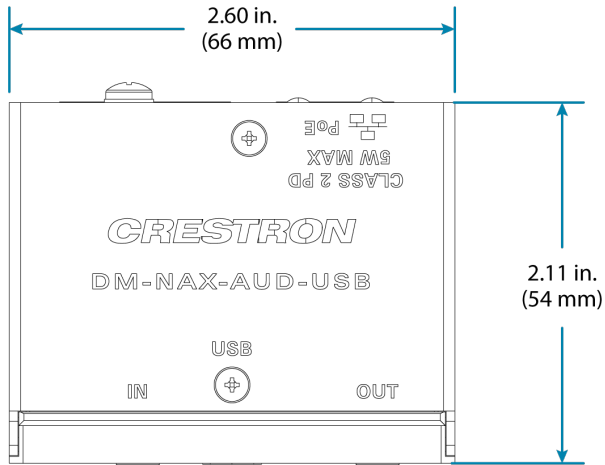

DM-NAX-BTIO-1G Specifications

Product specifications for the DM-NAX-BTIO-1G are provided below.

Specifications

Audio

Input Signal Types	Unbalanced stereo analog line-level; Stereo Bluetooth wireless; DM NAX/AES67 audio-over-IP
Output Signal Types	Unbalanced stereo analog line-level; DM NAX/AES67 audio-over-IP
Source Compensation	±10.0 dB per input
Input Monitoring	Source Signal Detect
Frequency Response (at line-level output)	20 Hz to 20 kHz ±0.5 dB
THD+N	Line-level: 0.005% @ 1 kHz, max output; Bluetooth: 0.05% @ 1 kHz, max output
S/N Ratio (at line-level output)	From line-level input: 108 dB, 20 Hz to 20 kHz, A-weighted; From digital input: 111 dB, 20 Hz to 20 kHz, A-weighted
Balance Control	Left/right adjustable

Communications

Ethernet	For control and PoE, AoIP, and/or console, 100/1000 Mbps, auto-switching, auto-negotiating, auto-discovery, full/half duplex, DHCP
Bluetooth	For audio input, Bluetooth 5.2 sink device, recalls up to seven previously paired devices, persistent or nonpersistent pairing, exclusive, interrupting, or temporary connection modes; Maximum Simultaneous Connections: 1 active device; Exclusive Connection Mode: Remembers up to 7 paired devices; Interrupt Connection Mode: Remembers up to 6 paired devices; Temporary Connection Mode: Remembers 1 paired device; Connection Range: 30 to 60 ft (9 to 18 m) typical, line-of-sight

Connectors

IN	(1) 3.5 mm connector, female TRS; Unbalanced line-level audio input; Maximum input level: 2V _{rms} ; Input Impedance: 10 k Ω
OUT	(1) 3.5 mm connector, female TRS; Unbalanced line-level audio output; Maximum output level: 2V _{rms} ; Channel separation: 80 dB @ 1 kHz; Output Impedance: 100 Ω

G	(1) 6-32 screw; Chassis ground lug
ETHERNET PoE	(1) 8-pin RJ-45 connector, female; 100BASE-TX/1000BASE-T Ethernet port

Controls and Indicators

Front Panel Display	(1) OLED screen, 128 x 64 dot matrix Height (active area): 0.43 in. (11 mm) Width (active area): 0.86 in. (22 mm) Displays metadata, menus, and volume feedback
Menu	(1) Push button Used to enter the front panel menu and select menu items
Bluetooth	(1) Push button Used to initiate Bluetooth pairing
UP and DOWN Arrows	(2) Push buttons Used to navigate menus and control volume
ETHERNET PoE	Left amber LED indicates 1000 Mb link status; Left green LED indicates 100 Mb link status; Flashing right amber LED indicates Ethernet activity
SETUP	(1) Push button: Used for factory reset procedures; (1) LED, illuminates red when the button is pressed, flashes red when reset has been initiated

Power

PoE	IEEE 802.3af Class 0 (12.95 W) compliant; Compatible with IEEE 802.3af compliant Ethernet switch or third-party PoE compliant PSE
Power Consumption	3.5 W

Environmental

Temperature	32° to 95° F (0° to 35° C)
Humidity	10% to 95% RH (noncondensing)
Heat Dissipation	11.95 BTU/hr

Construction

Chassis	Metal, black and silver finish, vented sides
Mounting	Mountable on the following: 1-gang U.S. electrical box or plaster ring (not included), 3.5 in. (26 mm) electrical box depth recommended; Rack rail

Dimensions

Height	4.12 in. (105 mm)
Width	1.76 in. (45 mm)
Depth	2.25 in. (57 mm)

Weight

4.8 oz. (136 g)

Compliance

Regulatory Model: M1845004

IC, FCC Part 15 Class B digital device

Dimension Drawing

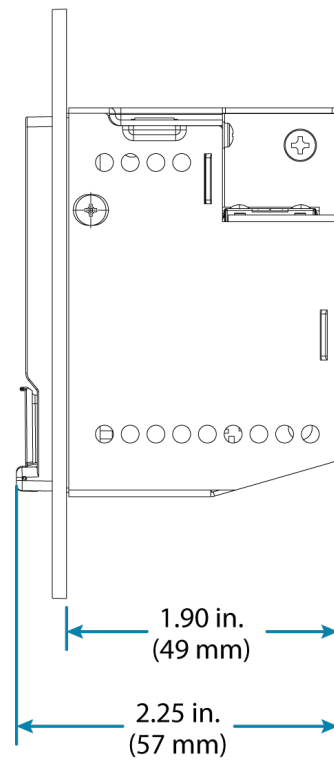
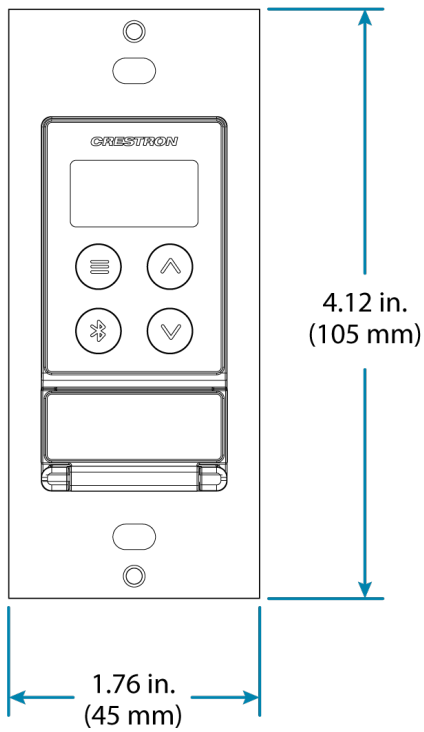
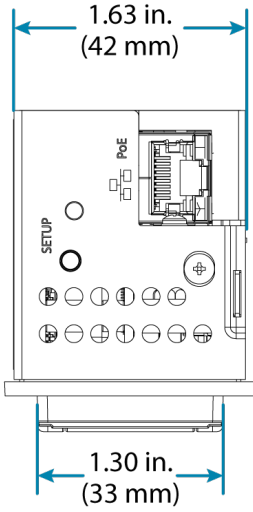

Installation

Refer to the following sections for instructions on how to install the various DM NAX devices.

- [DM-NAX-2XLRI-1G](#)
- [DM-NAX-8ZSA](#)
- [DM-NAX-4ZSA-50](#)
- [DM-NAX-4ZSP](#)
- [DM-NAX-16AIN](#)
- [DM-NAX-AMP-X300](#)
- [DM-NAX-AUD-IO](#)
- [DM-NAX-AUD-USB](#)
- [DM-NAX-BTIO-1G](#)

DM-NAX-2XLRI-1G Installation

Refer to the following sections to install the DM-NAX-2XLRI-1G.

- [In the Box on page 62](#)
- [Mounting the Device on page 62](#)
- [Connect the Device on page 65](#)
- [Reset the Device on page 66](#)

In the Box

Qty. Description

1 DM-NAX-2XLRI

Additional Items

2 Screw, 06-32, 3/4 in., Truss Head, Combo (2009211)

Mounting the Device

The DM-NAX-2XLRI-1G can be mounted into a 1-gang electrical box or onto a rack rail.

Mounting into a 1-Gang Electrical Box

NOTES:

- The DM-NAX-2XLRI-1G should only be mounted with a RACO® 3 in. x 2 in. x 2 in. gangable metal switch box with eight 0.5 in. knockouts and plaster ears (catalog ID #420), as it was designed to fit the box dimensions and knockout placements. Alternative metal switch boxes should not be used as they may have different knockout placements, which can lead to issues running the PoE connection to the unit due to cable bend radius restrictions.
- For thermal performance reasons, fully enclosed plastic back boxes should not be used with the DM-NAX-2XLRI-1G. In installations where an enclosed back box is not required, the DM-NAX-2XLRI-1G can be installed into most single gang metal or plastic mud rings.
- Connector boots should not be used on CAT5e (or greater) cables being connected to the DM-NAX-2XLRI-1G to avoid cable bend radius issues.

To mount the wall plate into a 1-gang electrical box:

1. Make connections to the rear of the device. For details, refer to [Top Panel on page 66](#).
2. Using a Phillips screwdriver and the two included 6-32 x 3/4 in. truss head screws, attach the wall plate to the electrical box.

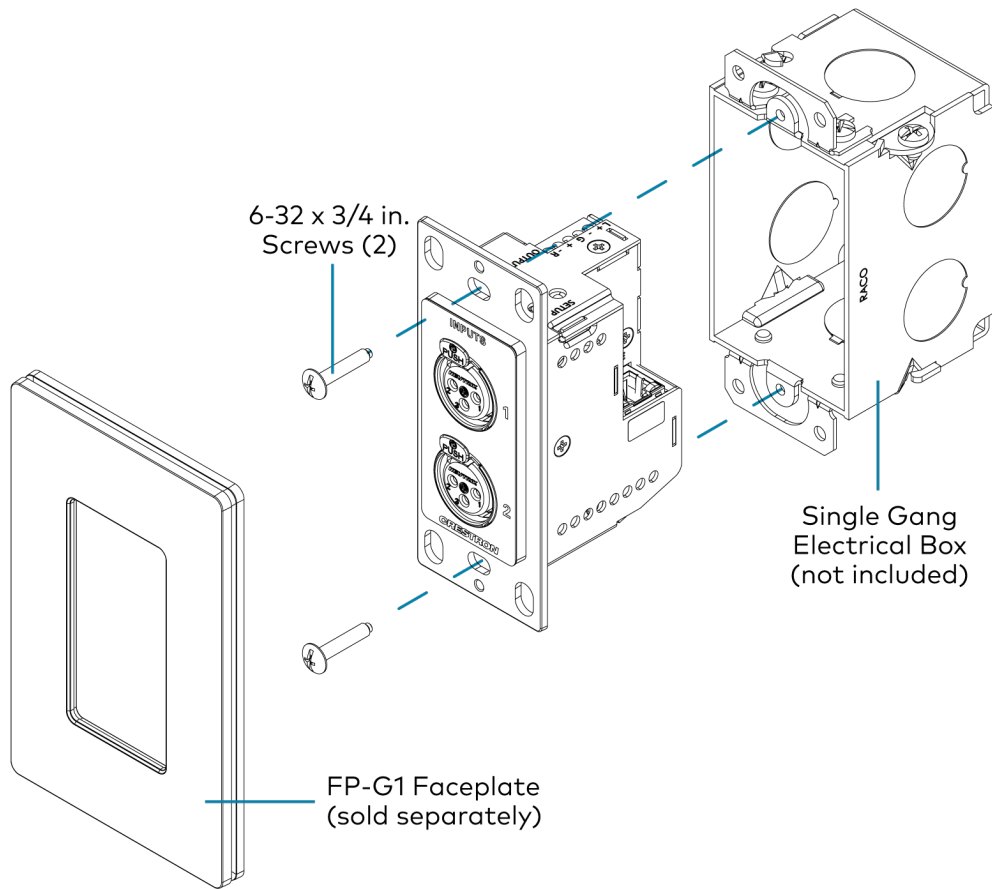

3. Using a Phillips screwdriver and two 6-32 x 1/4 in., flat head screws (not included), attach a FP-G1 decorator style faceplate (sold separately) to the wall plate.

Mounting onto a Rack Rail

To mount the wall plate onto a rack rail:

1. Position the wall plate horizontally so that the holes in the left or right mounting flange align with the holes in the rack rail.

2. Secure the wall plate to the rack rail using two mounting screws (not included).

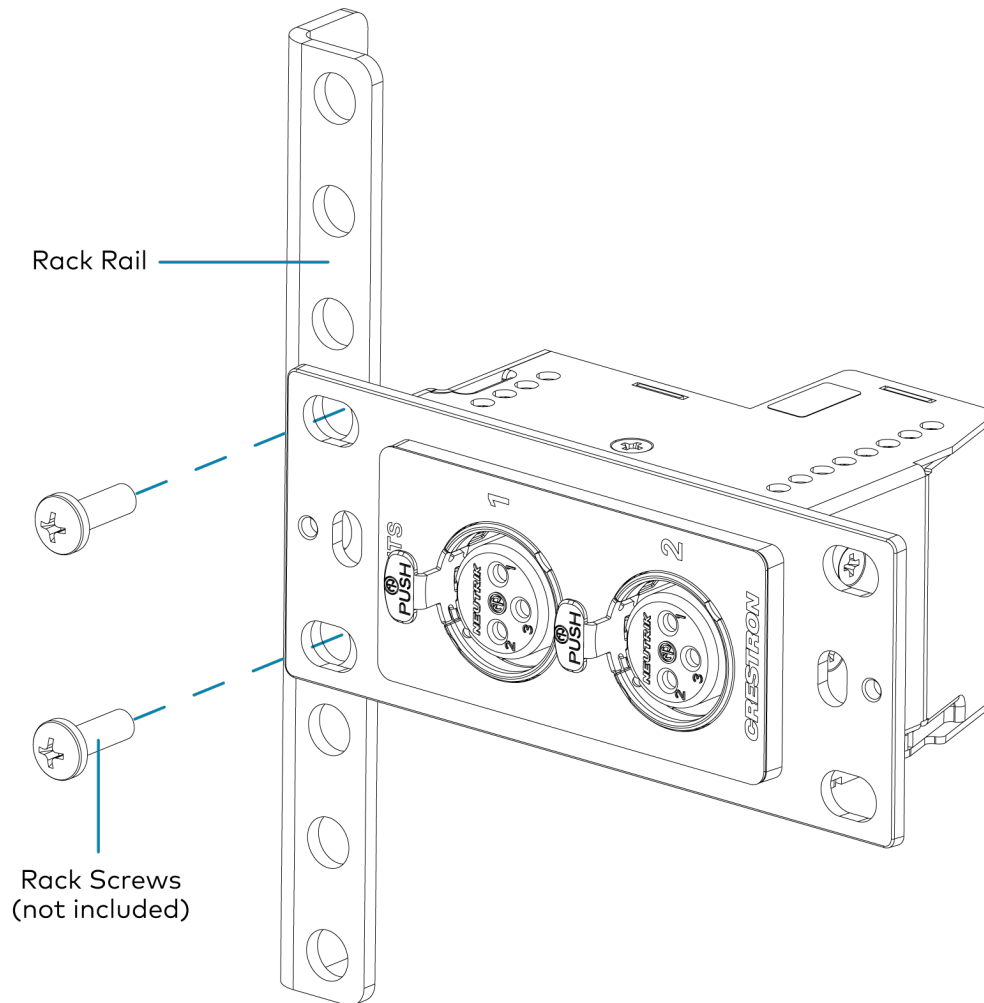

Mounting to a Flat Surface

To mount the wall plate to a flat surface:

1. Position the wall plate so that the holes in the mounting flange align with the mounting bracket (not included).

2. Connect the wall plate to the mounting bracket using a Phillips screwdriver and two SEMS screws 6-32 x 1/4 in. (not included).

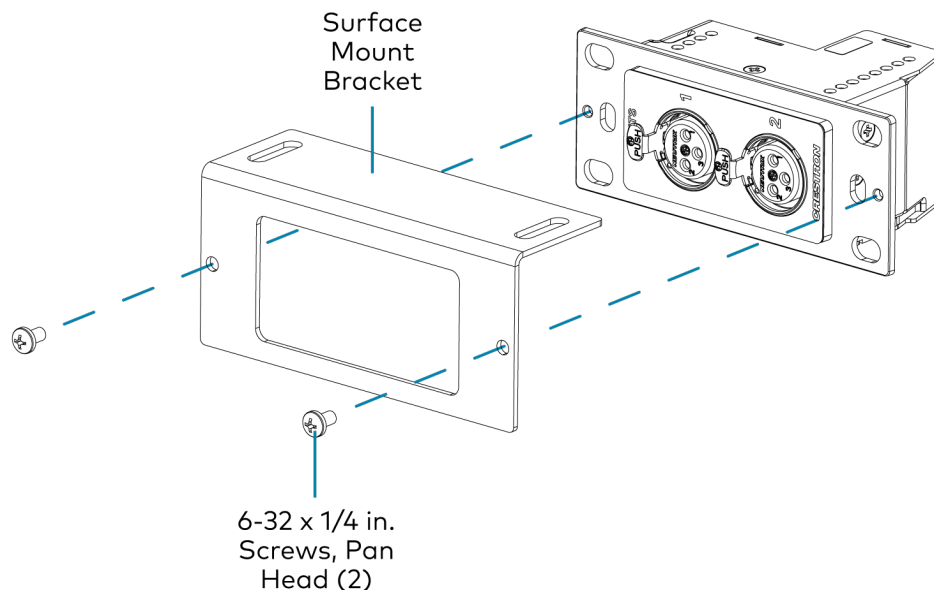

3. Secure the mounting bracket to a flat surface using the appropriate mounting screws (not included).

Connect the Device

Make connections to the front and top of the DM-NAX-2XLRI-1G.

Front Panel

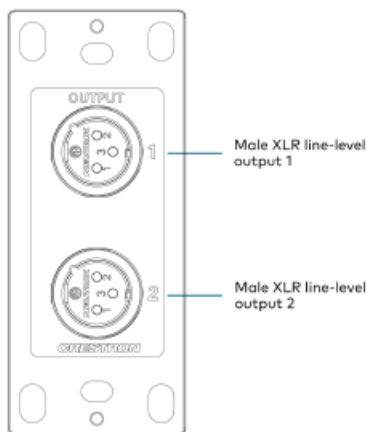

Top Panel

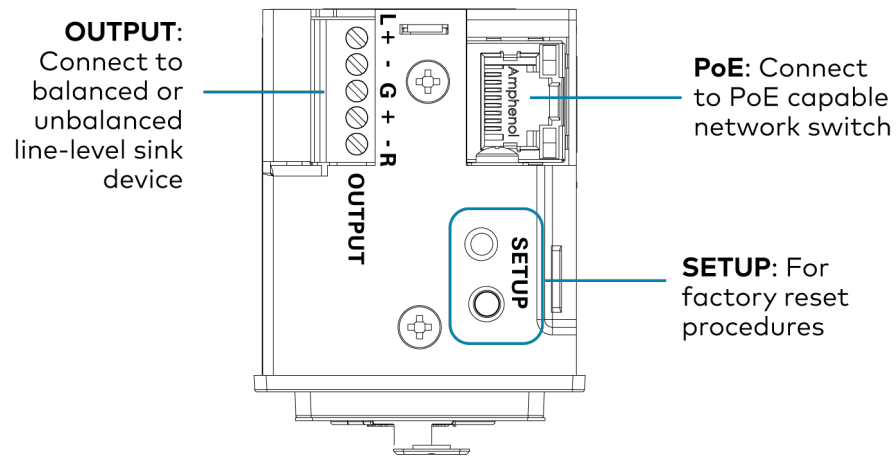

NOTE: PoE is a PoE powered device (PD) port. In order for the port to receive PoE, it must be connected to a PoE compliant Ethernet switch.

Connect a PoE capable network switch to the **PoE** port.

Connect a balanced or unbalanced line level sink device (such as the [MP-WP-2RCAO-1G](#) or [MP-WP-2XLRO-1G](#), sold separately) to the **OUTPUT** port.

Connect XLR sources to the front panel XLR connections.

Reset the Device

A network reset or factory restore may be performed when troubleshooting.

CAUTION: These procedures should only be performed as a last resort to recover an unresponsive device. Both the Network Reset and Factory Restore procedure will clear certain device settings that cannot be recovered once the procedure is complete. Before performing these procedures, please contact Crestron True Blue Support via phone, email or chat as described at www.crestron.com/support.

Network Reset

1. Ensure the device is powered on.
2. Press and hold the **SETUP** button for up to 15 seconds until the **SETUP** LED flashes red.

The device will reboot, and the default network settings will be reset. The device will be reverted to its default hostname, with DHCP enabled, and no static IP set.

Factory Restore

1. Turn off the device by disconnecting the power cable from the device.
2. Press and hold the **SETUP** button and then reconnect the power cable while still holding the **SETUP** button. Continue holding the **SETUP** button for up to 30 seconds until the **SETUP** LED flashes.

The device will reboot, and all the factory default settings will be restored, such as audio settings, multicast addressing, etc.

CAUTION: Performing a factory restore will clear all settings from the device configuration.

DM-NAX-8ZSA Installation

Refer to the following sections to install the DM-NAX-8ZSA.

- [In the Box on page 68](#)
- [Install the Device on page 68](#)
- [Connect the Device on page 70](#)
- [Apple® AirPlay® Setup on page 73](#)
- [Spotify® Connect Setup on page 74](#)
- [Observe the LED Indicators on page 75](#)
- [Reset the Device on page 75](#)

Front Panel

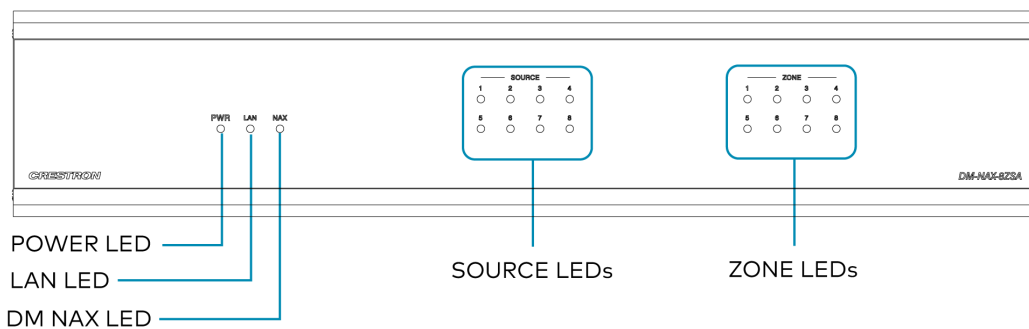

In the Box

Qty. Description

1 DM-NAX-8ZSA

Additional Items

- 2 Bracket, Rack Ear, 2 RU (2053799)
- 1 Power Cord, approx. 6.5 ft (2 m) (2014835)
- 1 Cable, CAT6, RJ45-to-RJ-45, approx. 5 ft (1.5 m) (2036196)
- 16 Connector, 2-Pin (2012361)
- 2 Connector, 4-Pin (2003576)
- 3 Connector, 5-Pin (2003577)
- 6 Screw, 4B x 1/4 in., Pan Head, Phillips (2007195)

Install the Device

Refer to the [Safety Instructions](#) (Doc. 6607) prior to installation.

The device can be placed on a table or installed in a rack.

Place on a Table

Place the device on a table or stack on top of another device.

Rack Installation

This device occupies 2 RU of rack space.

To install the included rack ears:

1. Use a #1 Phillips screwdriver to remove the three screws from each side of the front of the device as shown in the illustration.
2. Use the screwdriver and the six included 1/4 in. Phillips Pan Head screws to attach the included rack ears to the device.

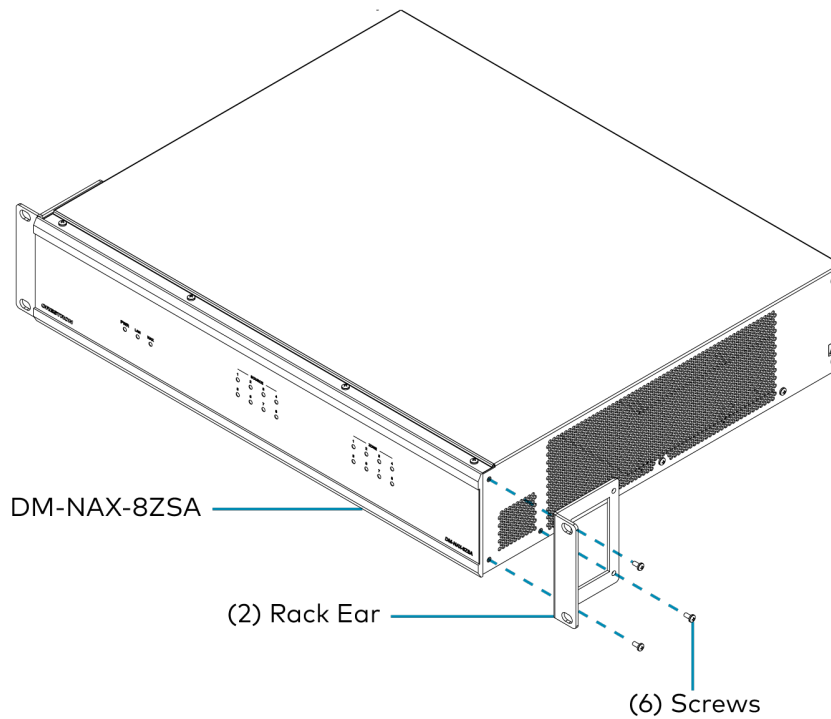

3. Mount the device into the rack using four rack mounting screws (not included).

Rack Mounting Safety Precautions

Elevated Operating Ambient Temperature: If installed in a closed or multi-unit rack assembly, the operating ambient temperature of the rack environment may be greater than room ambient temperature. Therefore, consideration should be given to installing the equipment in an environment compatible with the maximum ambient temperature (T_{ma}) specified by the manufacturer.

Reduced Airflow: Installation of the equipment in a rack should be such that the amount of airflow required for safe operation of the equipment is not compromised.

Mechanical Loading: Mounting of the equipment in the rack should be such that a hazardous condition is not achieved due to uneven mechanical loading.

Circuit Overloading: Consideration should be given to the connection of the equipment to the supply circuit and the effect that overloading of the circuits might have on overcurrent protection and supply wiring. Appropriate consideration of equipment nameplate ratings should be used when addressing this concern.

Reliable Earthing: Reliable earthing of rack-mounted equipment should be maintained. Particular attention should be given to supply connections other than direct connections to the branch circuit (e.g., use of power strips).

Connect the Device

Make the necessary connections as called out in the following illustration. Connect power last.

CAUTION:

- Keep the device unplugged until all of the input, network, output, and speaker wiring is complete.
- Check the speaker cables for shorts and frayed wiring around the SPEAKER OUTPUTS connectors.

NOTE:

- Ensure that the unit is properly grounded by connecting the chassis ground lug to an earth ground (building steel).
- To prevent overheating, do not operate this product in an area that exceeds the environmental temperature range listed in the product specifications.
- Do not bundle power cords together with connection cables. Doing so can result in noise.

Rear Panel

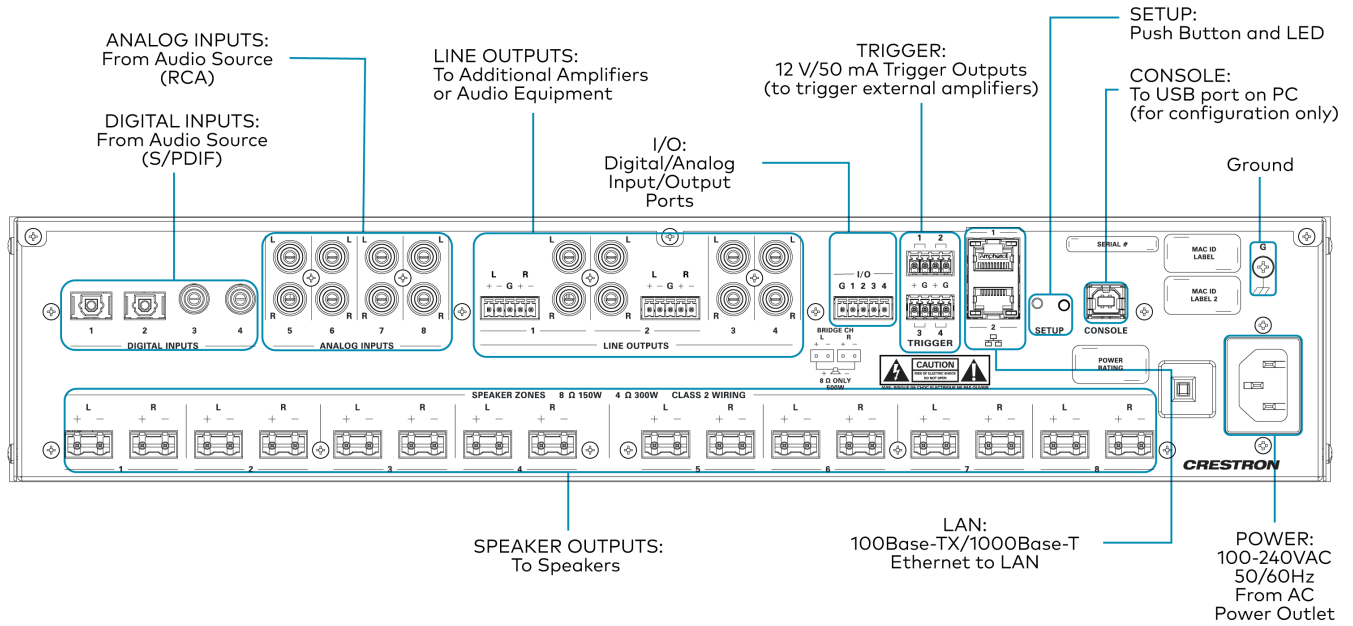

Digital Inputs

Refer to the following illustration when connecting digital audio sources.

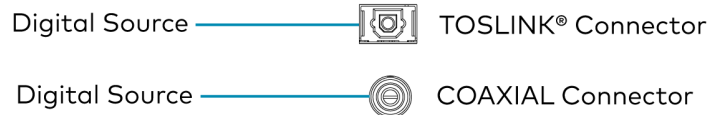

NOTE: 2-channel PCM digital audio is the only supported digital input format.

Analog Inputs

Refer to the following illustration when connecting analog audio sources.

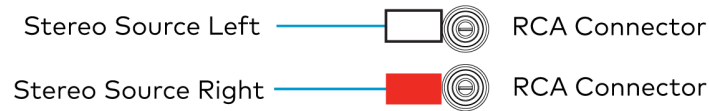

Speaker Connections

The speaker outputs can be wired conventionally or bridged together to deliver higher output power.

NOTE: The Line Outputs 1-4 mirror their respective Speaker Outputs 1-4. These outputs can feed another amplifier or an active subwoofer.

Conventional Wiring

Connect speakers to the DM-NAX-8ZSA as shown in the following illustration.

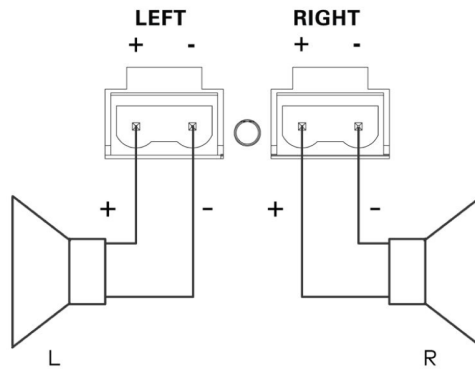

Bridged Wiring

Connect speaker outputs as shown in the following illustration to deliver more power to the speakers (8 ohm speakers only).

NOTE:

- Before wiring the speakers for bridging, ensure that the device is configured for bridging using web UI, Crestron Home™ software, or a Crestron SIMPL program running on a control system.
- Bridging can only be done between a left and a right output within the labeled zone.

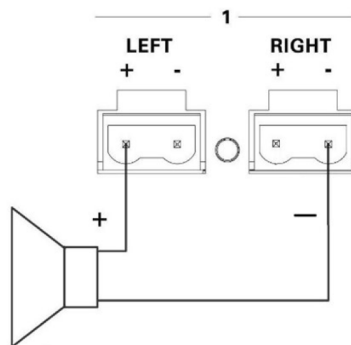

Balanced/Unbalanced Audio Output

Refer to the following table and illustration for analog audio output pin assignments and connection information.

Signal Name	Balanced Audio Output	Unbalanced Audio Output
+	L+	L+ Out
-	L-	Open
G	Shield/ground	Open
+	R+	R+ Out
-	R-	Open

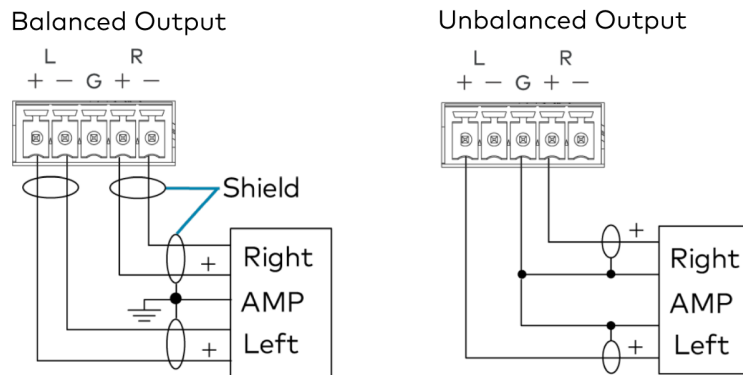

Apple® AirPlay® Setup

The DM-NAX-8ZSA supports AirPlay 2 and requires iOS 11.4 or later.

AirPlay can be enabled on any of the built-in media players on the DM-NAX-8ZSA.

To stream media from an iOS device to a speaker zone in your distributed audio system:

1. Ensure that the iOS device and DM-NAX-8ZSA are on the same network.
2. On the DM-NAX-8ZSA, enable AirPlay for the built-in media player you would like to stream to, either using the web UI or programming.

NOTE: If the control/media and Audio-over-IP network traffic is isolated between two network ports on the DM-NAX-8ZSA, AirPlay will use the port specified for the Control/Media traffic.

3. On your iOS device:
 - a. Enable AirPlay
 - b. From the list of available AirPlay destinations, select the DM-NAX-8ZSA zone you would like to stream to.
The media player will play back audio to the selected zone(s).

Once AirPlay streaming begins, you will be able to control the volume of the streaming DM-NAX-8ZSA speaker zones directly from your iOS device.

NOTE: By default, media players 1 - 8 route the audio signals to their corresponding speaker zones when Airplay streaming begins. If the user has not already specified a destination speaker zone for the media player when streaming begins, the media player will automatically route to its default speaker zone. For example, if a user streams Airplay to media player 3, the audio will be routed to speaker zone 3.

Spotify® Connect Setup

The DM-NAX-8ZSA supports Spotify Connect.

To configure Spotify, use your phone, tablet or computer as a remote control for Spotify. Go to spotify.com/connect to learn how.

Spotify Connect can be enabled on any of the built-in media players on the DM-NAX-8ZSA.

To stream media from a device to a speaker zone in your distributed audio system:

1. Ensure that the device and DM-NAX-8ZSA are on the same network.
2. On the DM-NAX-8ZSA, enable Spotify Connect for the built-in media player you would like to stream to, either using the web UI or programming.

NOTE: If the control/media and Audio-over-IP network traffic is isolated between two network ports on the DM-NAX-8ZSA, Spotify will use the port specified for the Control/Media traffic.

3. On your device:
 - a. Open the Spotify application or web client.
 - b. From the list of available Spotify destinations, select the DM-NAX-8ZSA zone you would like to stream to.

The media player will play back audio to the selected zone(s).

Once Spotify Connect streaming begins, you will be able to control the volume of the streaming DM-NAX-8ZSA speaker zones directly from the Spotify application on your device.

NOTE: By default, media players 1 - 8 route the audio signals to their corresponding speaker zones when Spotify Connect streaming begins. If the user has not already specified a destination speaker zone when streaming begins, the media player will automatically route to its default speaker zone. For example, if a user streams Spotify Connect to media player 3, the audio will be routed to speaker zone 3.

Observe the LED Indicators

Refer to the following table for information about the LED indicators on the device.

LED Indicator	Color	Meaning
PWR	Amber	Power is being applied to the device. The device is booting.
	White	Device is powered on with audio passing.
	Red	Device is in standby mode.
LAN	White	The device is powered on and has a valid IP address.
	Off	Device is not connected to a network or the IP address is invalid.
NAX	White	AoIP is ready to pass and the unit's PTP clock is synced.
	Off	No AoIP is passing to or from and/or PTP is not synced.
SOURCE 1-8	White	Signal is detected on the specified input/source.
	Red	There is clipping on an analog input or bitstream audio detected on a digital input.
	Off	There is no signal detected on the specified input/source.
ZONE 1-8	White	There is audio output on the indicated zone.
	Red	Clipping or a fault is detected on the zone output due to over current, over temperature, or low voltage.
SETUP	Solid Red	The SETUP button is pressed.
	Blinking Red	A network reset or factory restore has been initiated via the adjacent SETUP button.

Reset the Device

A network reset or factory restore may be performed when troubleshooting.

CAUTION: These procedures should only be performed as a last resort to recover an unresponsive device. Both the Network Reset and Factory Restore procedure will clear certain device settings that cannot be recovered once the procedure is complete. Before performing these procedures, please contact Crestron True Blue Support via phone, email or chat as described at www.crestron.com/support.

Network Reset

1. Ensure the device is powered on.
2. Press and hold the **SETUP** button for up to 15 seconds until the **SETUP** LED flashes red.

The device will reboot, and the default network settings will be reset. The device will be reverted to its default hostname, with DHCP enabled, and no static IP set.

Factory Restore

1. Turn off the device by disconnecting the power cable from the device.
2. Press and hold the **SETUP** button and then reconnect the power cable while still holding the **SETUP** button. Continue holding the **SETUP** button for up to 30 seconds until the **SETUP** LED flashes.

The device will reboot, and all the factory default settings will be restored, such as Zone settings, streaming service accounts, multicast addressing, etc.

CAUTION: Performing a factory restore will clear all settings from the device configuration.

DM-NAX-4ZSA-50 Installation

Refer to the following sections to install the DM-NAX-4ZSA-50.

- [In the Box on page 77](#)
- [Install the Device on page 77](#)
- [Connect the Device on page 81](#)
- [Spotify® Setup on page 83](#)
- [Reset the Device on page 84](#)
- [Observe the LED Indicators on page 84](#)

In the Box

Qty. Description

1 DM-NAX-4ZSA-50

Additional Items

- 1 Power Cord, approx. 6.5 ft (2m) (2001134)
- 2 Bracket, rack ear, quarter-wide (2057495)
- 4 Joining plate (2056313)
- 4 Speaker Connector, 4-Pin (2057001)
- 4 Screw, 6-32 x 5/16 in., Flat Head, Phillips (2007223)
- 8 Screw, 8-32 x 5/16 in., Phillips (2056985)
- 4 Adhesive feet (2002389)

Install the Device

Refer to the [Safety Instructions](#) (Doc. 6607) prior to installation.

The device can be placed on a table or installed in a rack.

Place on a Table

Attach the four adhesive feet to the bottom of the device. Place the device on a table or stack on top of another device.

Rack Installation

This device occupies 1/2 RU of rack space.

To install the included rack ears:

1. Use a #1 Phillips screwdriver and the included 6-32 5/16 in. Phillips screws to attach the included rack ears to the device.

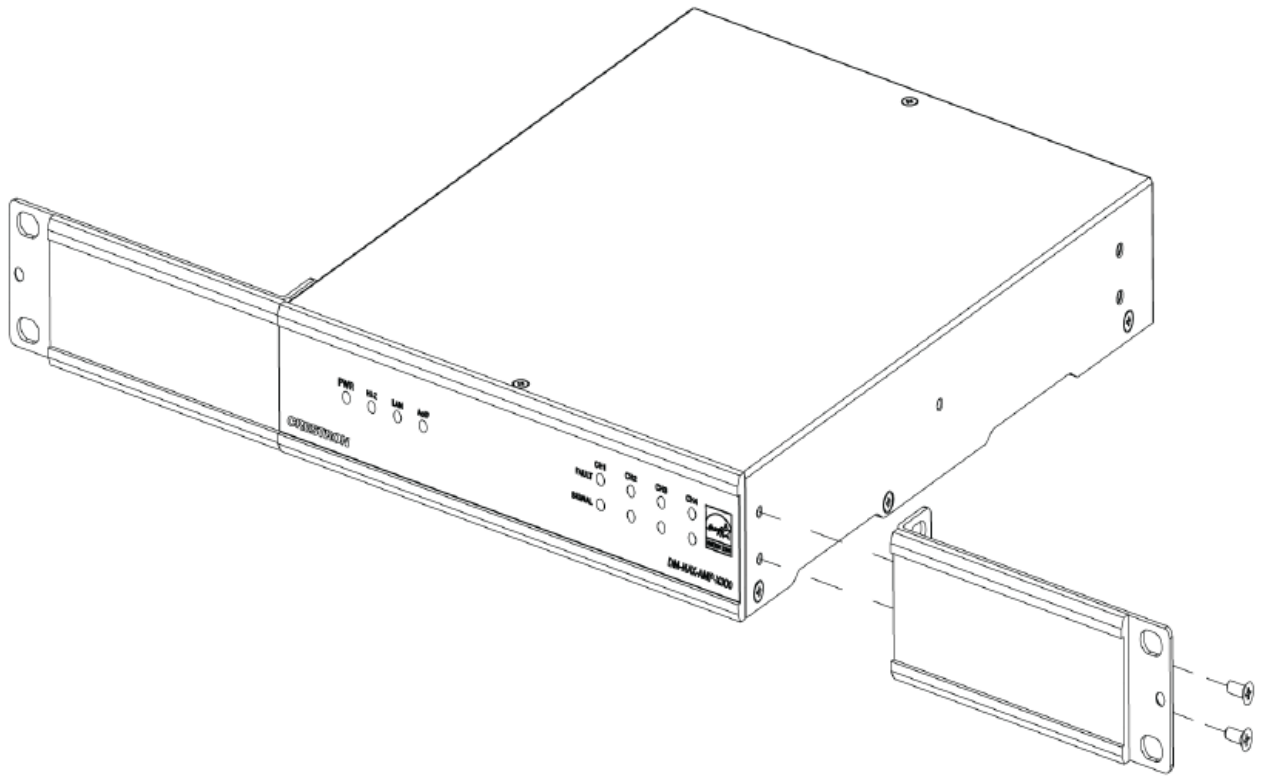

2. Mount the device into the rack using four rack mounting screws (not included).

Double Mount

To rack-mount two Crestron 1/2 RU units together:

1. On a flat surface, place the devices upside-down and adjacent to each other.
2. Using a Philips screwdriver and the eight included 8-32 x 5/16 in. screws, gang the devices together with two of the joining plates.

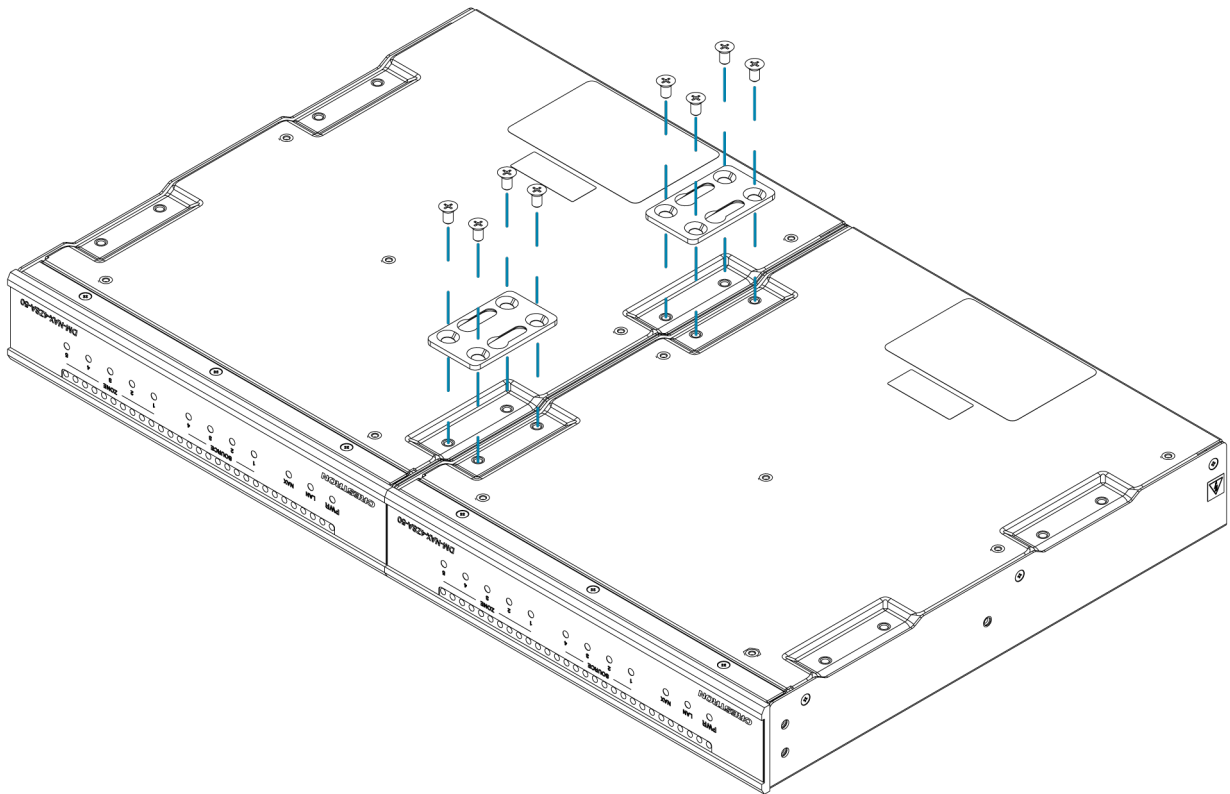

3. Turn the device assembly over and, using six 6-32 x 5/16 in. screws, attach the rack ears to each side.

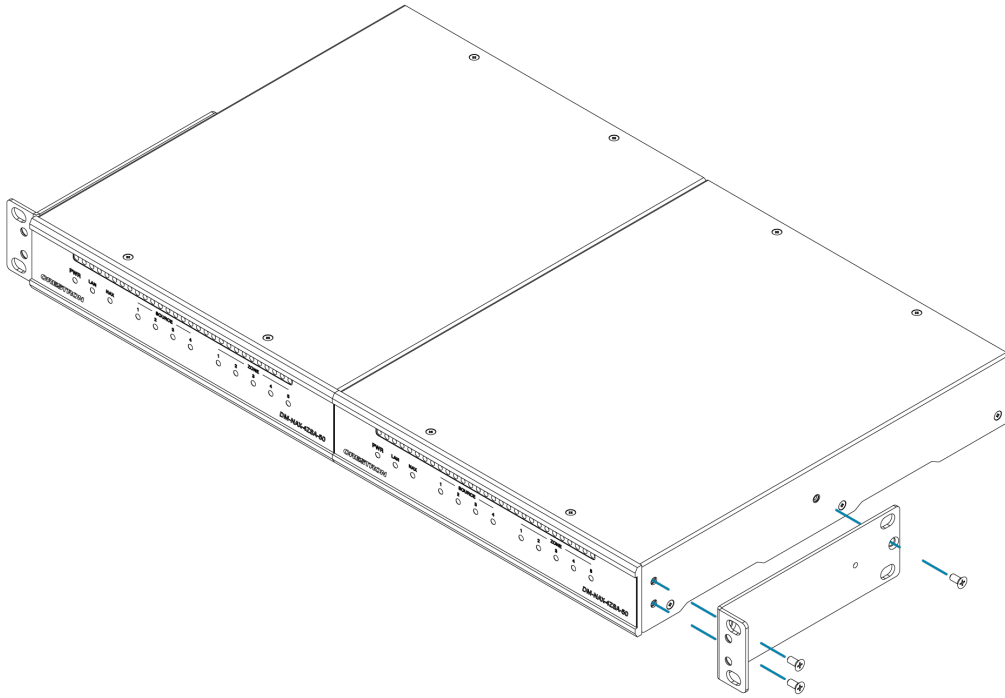

4. Mount the assembly into the rack using four rack mounting screws (not included).

Rack Mounting Safety Precautions

Elevated Operating Ambient Temperature: If installed in a closed or multi-unit rack assembly, the operating ambient temperature of the rack environment may be greater than room ambient temperature. Therefore, consideration should be given to installing the equipment in an environment compatible with the maximum ambient temperature (T_{ma}) specified by the manufacturer.

Reduced Airflow: Installation of the equipment in a rack should be such that the amount of airflow required for safe operation of the equipment is not compromised.

Mechanical Loading: Mounting of the equipment in the rack should be such that a hazardous condition is not achieved due to uneven mechanical loading.

Circuit Overloading: Consideration should be given to the connection of the equipment to the supply circuit and the effect that overloading of the circuits might have on overcurrent protection and supply wiring. Appropriate consideration of equipment nameplate ratings should be used when addressing this concern.

Reliable Earthing: Reliable earthing of rack-mounted equipment should be maintained. Particular attention should be given to supply connections other than direct connections to the branch circuit (e.g., use of power strips).

Connect the Device

Make the necessary connections as called out in the following illustration. Connect power last.

CAUTION:

- Keep the device unplugged until all of the input, network, output, and speaker wiring is complete.
- Check the speaker cables for shorts and frayed wiring around the SPEAKER ZONES connectors.

NOTE:

- Ensure that the unit is properly grounded by connecting the chassis ground lug to an earth ground (building steel).
- To prevent overheating, do not operate this product in an area that exceeds the environmental temperature range listed in the product specifications.
- Do not bundle power cords together with connection cables. Doing so can result in noise.

Rear Panel

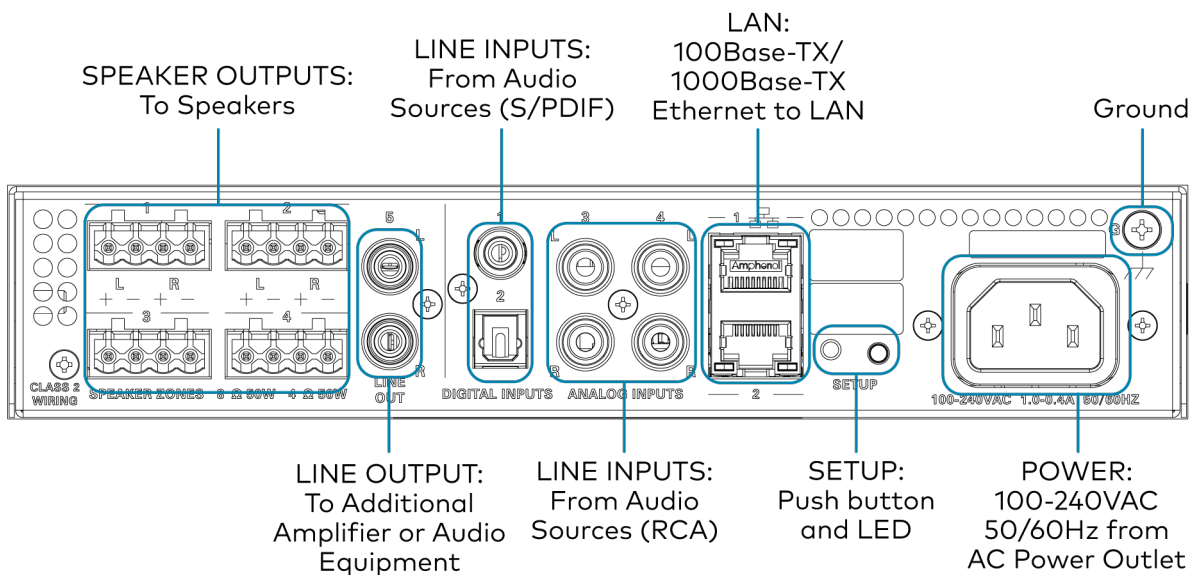

Digital Inputs

Refer to the following illustration when connecting digital audio sources.

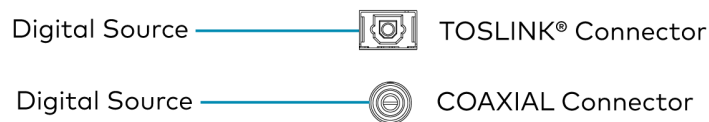

NOTE: Only 2-channel PCM digital audio is supported at the digital inputs.

Analog Inputs

Refer to the following illustration when connecting analog audio sources.

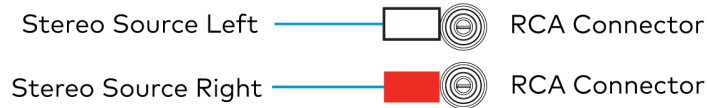

Speaker Connections

Connect speakers to the DM-NAX-4ZSA-50 as shown in the following illustration.

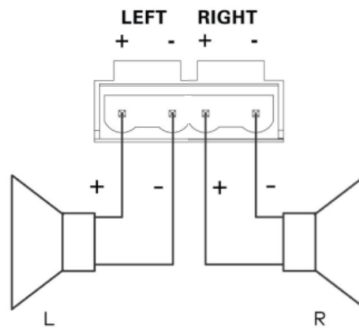

Apple® AirPlay® Setup

The DM-NAX-4ZSA-50 supports AirPlay 2 and requires iOS 11.4 or later.

AirPlay can be enabled on any of the built-in media players on the DM-NAX-4ZSA-50.

To stream media from an iOS device to a speaker zone in your distributed audio system:

1. Ensure that the iOS device and DM-NAX-4ZSA-50 are on the same network.
2. On the DM-NAX-4ZSA-50, enable AirPlay for the built-in media player you would like to stream to, either using the web UI or programming.

NOTE: If the control/media and Audio-over-IP network traffic is isolated between two network ports on the DM-NAX-4ZSA-50, AirPlay will use the port specified for the Control/Media traffic.

3. On your iOS device:
 - a. Enable AirPlay
 - b. From the list of available AirPlay destinations, select the DM-NAX-4ZSA-50 zone you would like to stream to.

The media player will play back audio to the selected zone(s).

NOTE: By default, media players 1 - 5 route the audio signals to their respectively numbered speaker zones 1 - 5. If the user has not specified the speaker zone when Airplay streaming begins, the media player will automatically route to its default speaker zone. For example, the audio from the media player 3 will be routed to speaker zone 3.

After the AirPlay streaming begins, you will be able to control the volume of the streaming DM-NAX-4ZSA-50 speaker zones directly from your iOS device.

Spotify® Setup

The DM-NAX-4ZSA-50 supports Spotify.

To configure Spotify, use your phone, tablet or computer as a remote control for Spotify. Go to spotify.com/connect to learn how.

Spotify can be enabled on any of the built-in media players on the DM-NAX-4ZSA-50.

To stream media from a device to a speaker zone in your distributed audio system:

1. Ensure that the device and DM-NAX-4ZSA-50 are on the same network.
2. On the DM-NAX-4ZSA-50, enable Spotify for the built-in media player you would like to stream to, either using the web UI or programming.

NOTE: If the control/media and Audio-over-IP network traffic is isolated between two network ports on the DM-NAX-4ZSA-50, Spotify will use the port specified for the Control/Media traffic.

3. On your device:
 - a. Enable Spotify
 - b. From the list of available Spotify destinations, select the DM-NAX-4ZSA-50 zone you would like to stream to.

The media player will play back audio to the selected zone(s).

NOTE: By default, media players 1 - 5 route the audio signals to their respectively numbered speaker zones 1 - 5. If the user has not specified the speaker zone when Spotify streaming begins, the media player will automatically route to its default speaker zone. For example, the audio from the media player 3 will be routed to speaker zone 3.

After the Spotify streaming begins, you will be able to control the volume of the streaming DM-NAX-4ZSA-50 speaker zones directly from the Spotify application on the casting device.

Observe the LED Indicators

Refer to the following table for information about the LED indicators on the device.

LED Indicator	Color	Meaning
PWR	Amber	Power is being applied to the device. The device is booting.
	White	Device is powered on with audio passing.
	Red	Device is in standby mode.
Ethernet 1	White	The device is powered on and has a valid IP address.
	Off	Device is not connected to a network or the IP address is invalid.
Ethernet 2	White	AoIP is ready to pass and the unit's PTP clock is synced.
	Off	No AoIP is passing to or from and/or PTP is not synced.
SOURCE 1-4	White	Signal is detected on the specified input/source.
	Red	There is clipping on an analog input or bitstream audio detected on a digital input.
	Off	There is no signal detected on the specified input/source.
ZONE 1-4	White	There is audio output on the indicated zone.
	Red	Clipping or a fault is detected on the zone output due to over current, over temperature, or low voltage.
ZONE 5	White	There is audio output on the indicated zone.
	Red	Clipping is detected on the zone output due to over current, over temperature, or low voltage.
SETUP	Solid Red	The SETUP button is pressed.
	Blinking Red	A network reset or factory restore has been initiated via the adjacent SETUP button.

Reset the Device

A network reset or factory restore may be performed when troubleshooting.

CAUTION: These procedures should only be performed as a last resort to recover an unresponsive device. Both the Network Reset and Factory Restore procedure will clear certain device settings that cannot be recovered once the procedure is complete. Before performing these procedures, please contact Crestron True Blue Support via phone, email or chat as described at www.crestron.com/support.

Network Reset

1. Ensure the device is powered on.
2. Press and hold the **SETUP** button for up to 15 seconds until the **SETUP** LED flashes red.

The device will reboot, and the default network settings will be reset. The device will be reverted to its default hostname, with DHCP enabled, and no static IP set.

Factory Restore

1. Turn off the device by disconnecting the power cable from the device.
2. Press and hold the **SETUP** button and then reconnect the power cable while still holding the **SETUP** button. Continue holding the **SETUP** button for up to 30 seconds until the **SETUP** LED flashes.

The device will reboot, and all the factory default settings will be restored, such as Zone settings, streaming service accounts, multicast addressing, etc.

CAUTION: Performing a factory restore will clear all settings from the device configuration.

DM-NAX-4ZSP Installation

Refer to the following sections to install the DM-NAX-4ZSP.

- [In the Box on page 86](#)
- [Install the Device on page 86](#)
- [Connect the Device on page 88](#)
- [Observe the LED Indicators on page 92](#)
- [Apple® AirPlay® Setup on page 90](#)
- [Spotify® Connect Setup on page 91](#)
- [Reset the Device on page 93](#)

Front Panel

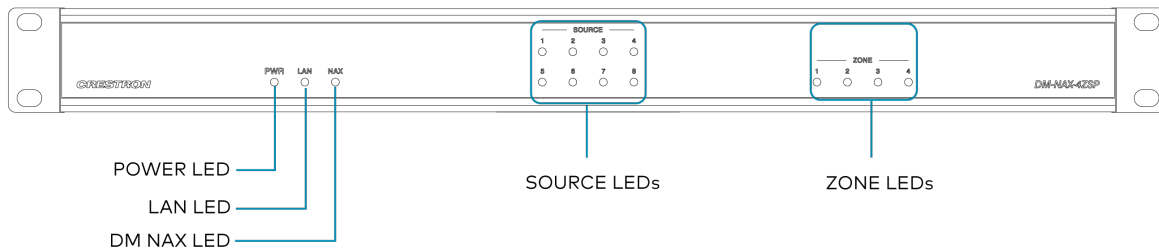

In the Box

Qty. Description

- | Qty. | Description |
|------|-------------|
| 1 | DM-NAX-4ZSP |

Additional Items

- | | |
|---|--------------------------------------------|
| 2 | Bracket, Rack Ear, 2 RU (2032122) |
| 1 | Power Cord, approx. 6.5 ft (2 m) (2001134) |
| 2 | Connector, 4-Pin (2003576) |
| 3 | Connector, 5-Pin (2003577) |
| 4 | Feet, Adhesive (2002389) |

Install the Device

Refer to the [Safety Instructions](#) (Doc. 6607) prior to installation.

The device can be placed on a table or installed in a rack.

Place on a Flat Surface

Place the device on a flat surface such as a table.

Install in a Rack

This device occupies 1U of rack space.

To mount the device into a rack:

1. Use a Phillips screwdriver (not included) to remove the three screws from each side of the device as shown in the illustration.
2. Use the screwdriver and the six screws (removed earlier) to attach the included rack ears to the device.

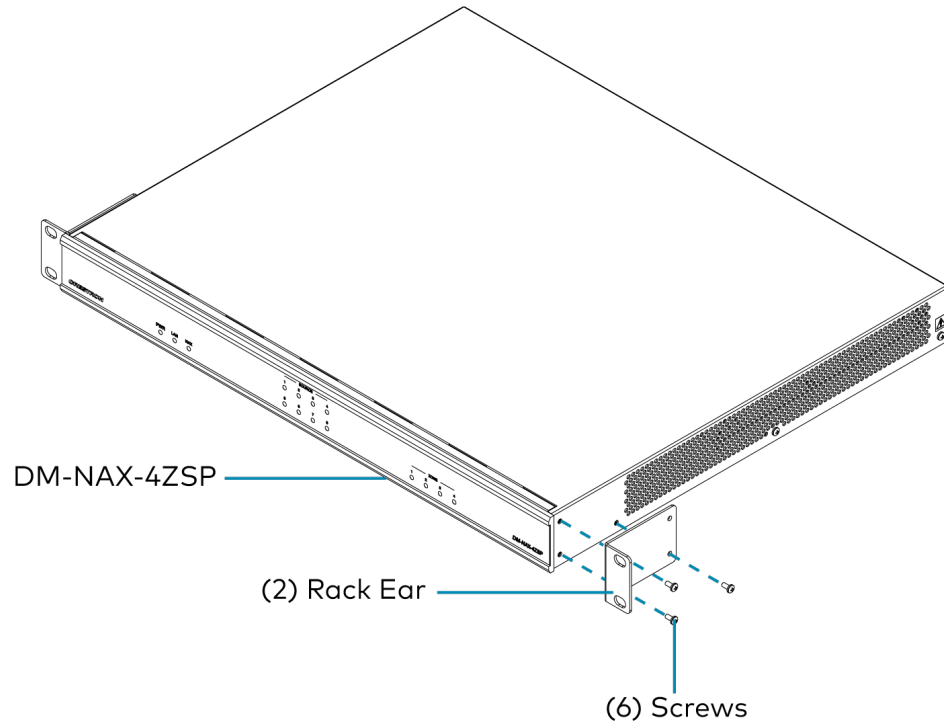

3. Mount the device into the rack using four rack mounting screws (not included).

Rack Mounting Safety Precautions

Elevated Operating Ambient Temperature: If installed in a closed or multi-unit rack assembly, the operating ambient temperature of the rack environment may be greater than the room ambient temperature. Therefore, consideration should be given to installing the equipment in an environment compatible with the maximum ambient temperature (T_{ma}) specified by the manufacturer.

Reduced Airflow: Installation of the equipment in a rack should be such that the amount of airflow required for safe operation of the equipment is not compromised.

Mechanical Loading: Mounting of the equipment in the rack should be such that a hazardous condition is not achieved due to uneven mechanical loading.

Circuit Overloading: Consideration should be given to the connection of the equipment to the supply circuit and the effect that overloading of the circuits might have on overcurrent protection and supply wiring. Appropriate consideration of equipment nameplate ratings should be used when addressing this concern.

Reliable Earthing: Reliable earthing of rack-mounted equipment should be maintained. Particular attention should be given to supply connections other than direct connections to the branch circuit (e.g., use of power strips).

Connect the Device

Make the necessary connections as called out in the following illustration. Connect power last.

CAUTION:

- Keep the device unplugged until all of the input, network, output, and speaker wiring is complete.

NOTES:

- Ensure that the unit is properly grounded by connecting the chassis ground lug to an earth ground (building steel).
- To prevent overheating, do not operate this product in an area that exceeds the environmental temperature range of 32° to 104°F (0° to 40°C).
- Do not bundle power cords together with connection cables. Doing so can result in noise.

Rear Panel

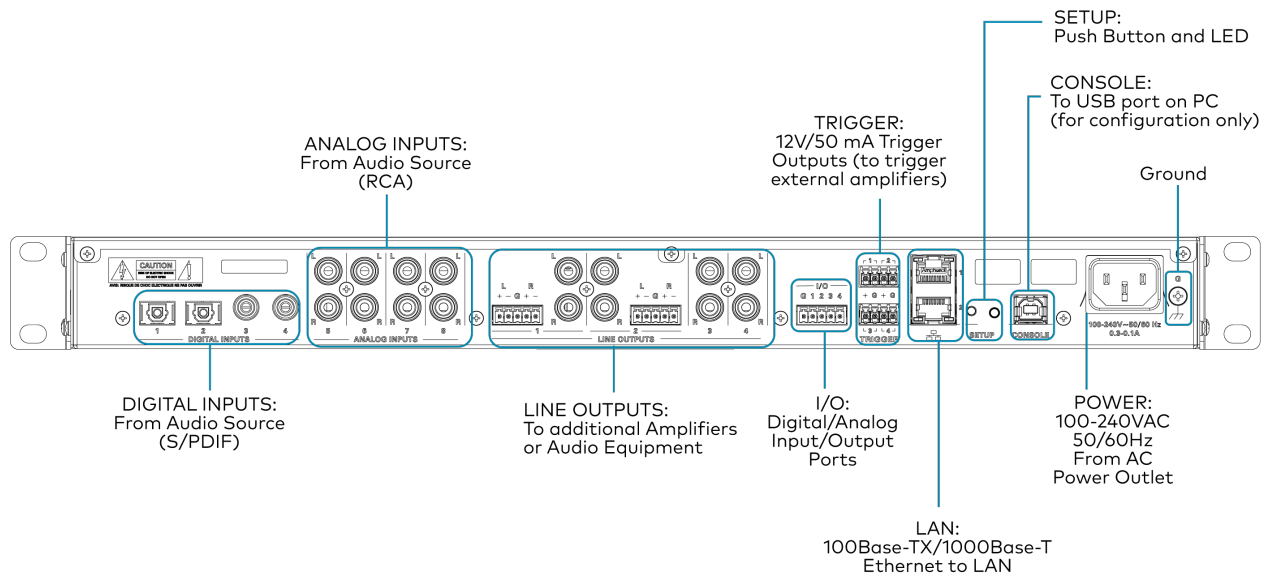

Digital Inputs

Refer to the following illustration when connecting digital audio sources.

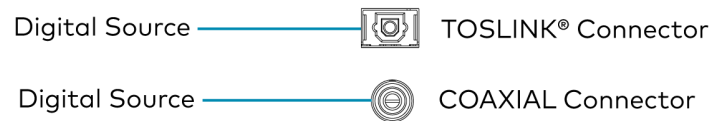

NOTE: 2-channel PCM digital audio is the only supported digital input format.

Analog Inputs

Refer to the following illustration when connecting analog audio sources.



Balanced/Unbalanced Audio Output

Refer to the following table and illustration for analog audio output pin assignments and connection information.

Signal Name	Balanced Audio Output	Unbalanced Audio Output
+	L+	L+
-	L-	L Shield
G	Shield/ground	G, L Shield, and R Shield
+	R+	R+
-	R-	R Shield

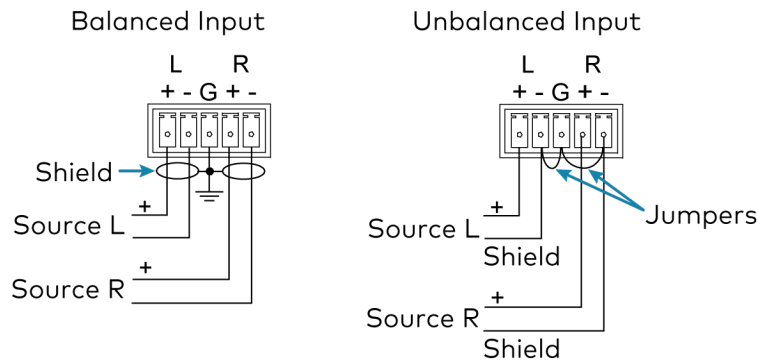

Apple® AirPlay® Setup

The DM-NAX-4ZSP supports AirPlay 2 and requires iOS 11.4 or later.

AirPlay can be enabled on any of the built-in media players on the DM-NAX-4ZSP.

To stream media from an iOS device to an output zone in your distributed audio system:

1. Ensure that the iOS device and DM-NAX-4ZSP are on the same network.
2. On the DM-NAX-4ZSP, enable AirPlay for the built-in media player you would like to stream to, either using the web UI or programming.

NOTE: If the control/media and Audio-over-IP network traffic is isolated between two network ports on the DM-NAX-4ZSP, AirPlay will use the port specified for the Control/Media traffic.

3. On your iOS device:
 - a. Enable AirPlay
 - b. From the list of available AirPlay destinations, select the DM-NAX-4ZSP zone you would like to stream to.

The media player will play back audio to the selected zone(s).

Once AirPlay streaming begins, you will be able to control the volume of the streaming DM-NAX-4ZSP output zones directly from your iOS device.

NOTE: By default, media players 1 - 4 route the audio signals to their corresponding output zones when Airplay streaming begins. If the user has not already specified a destination output zone for the media player when streaming begins, the media player will automatically route to its default output zone. For example, if a user streams Airplay to media player 3, the audio will be routed to output zone 3.

Spotify® Connect Setup

The DM-NAX-4ZSP supports Spotify Connect.

To configure Spotify, use your phone, tablet or computer as a remote control for Spotify. Go to spotify.com/connect to learn how.

Spotify Connect can be enabled on any of the built-in media players on the DM-NAX-4ZSP.

To stream media from a device to a output zone in your distributed audio system:

1. Ensure that the device and DM-NAX-4ZSP are on the same network.
2. On the DM-NAX-4ZSP, enable Spotify Connect for the built-in media player you would like to stream to, either using the web UI or programming.

NOTE: If the control/media and Audio-over-IP network traffic is isolated between two network ports on the DM-NAX-4ZSP, Spotify will use the port specified for the Control/Media traffic.

3. On your device:
 - a. Open the Spotify application or web client.
 - b. From the list of available Spotify destinations, select the DM-NAX-4ZSP zone you would like to stream to.

The media player will play back audio to the selected zone(s).

Once Spotify Connect streaming begins, you will be able to control the volume of the streaming DM-NAX-4ZSP output zones directly from the Spotify application on your device.

NOTE: By default, media players 1 - 4 route the audio signals to their corresponding output zones when Spotify Connect streaming begins. If the user has not already specified a destination output zone when streaming begins, the media player will automatically route to its default output zone. For example, if a user streams Spotify Connect to media player 3, the audio will be routed to output zone 3.

Observe the LED Indicators

Refer to the following table for information about the LED indicators on the device.

LED Indicator	Color	Meaning
PWR	White	Device is powered on with audio passing.
	Red	Device is in standby mode.
	Off	Device is not powered on.
LAN	White	The device is powered on and has a valid IP address.
	Off	Device is not connected to a network or the IP address is invalid.
NAX	White	AoIP is ready to pass and the unit's PTP clock is synced.
	Off	No AoIP is passing to or from the unit and/or PTP is not synced.
SOURCE 1-8	White	Signal is detected on the specified input/source.
	Red	There is clipping on an analog input or bitstream audio detected on a digital input.
	Off	There is no signal detected on the specified input/source.
ZONE 1-4	White	There is audio output on the indicated zone.
	Red	Clipping is detected on the output audio.
SETUP	Solid Red	The SETUP button is pressed.
	Blinking Red	A network reset or factory restore has been initiated via the adjacent SETUP button.

Reset the Device

A network reset or factory restore may be performed when troubleshooting.

CAUTION: These procedures should only be performed as a last resort to recover an unresponsive device. Both the Network Reset and Factory Restore procedure will clear certain device settings that cannot be recovered once the procedure is complete. Before performing these procedures, please contact Crestron True Blue Support via phone, email or chat as described at www.crestron.com/support.

Network Reset

1. Ensure the device is powered on.
2. Press and hold the **SETUP** button for up to 15 seconds until the **SETUP** LED flashes red.

The device will reboot, and the default network settings will be reset. The device will be reverted to its default hostname, with DHCP enabled, and no static IP set.

Factory Restore

1. Turn off the device by disconnecting the power cable from the device.
2. Press and hold the **SETUP** button and then reconnect the power cable while still holding the **SETUP** button. Continue holding the **SETUP** button for up to 30 seconds until the **SETUP** LED flashes.

The device will reboot, and all the factory default settings will be restored, such as Zone settings, streaming service accounts, multicast addressing, etc.

CAUTION: Performing a factory restore will clear all settings from the device configuration.

DM-NAX-16AIN Installation

Refer to the following sections to install the DM-NAX-16AIN.

- [In the Box on page 94](#)
- [Install the Device on page 95](#)
- [Connect the Device on page 97](#)
- [Observe the LED Indicators on page 99](#)
- [Reset the Device on page 100](#)

Front Panel

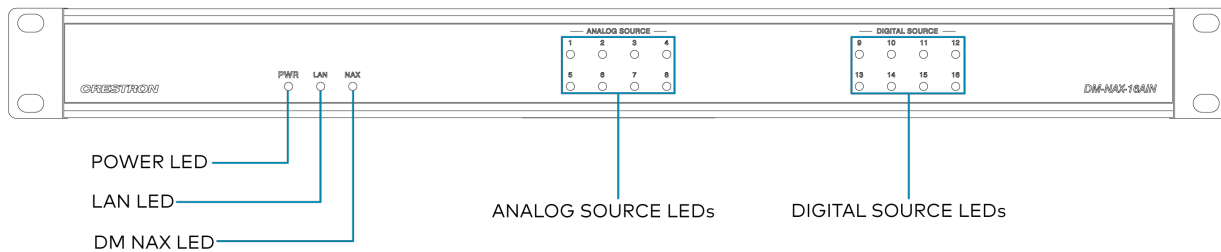

In the Box

Qty. Description

1	DM-NAX-16AIN
---	--------------

Additional Items

2	Bracket, Rack Ear, 1U (2032122)
4	Connector, 5-Pin (2003577)
1	Power Cord, 6 ft 7 in. (2 m) (2001134)

Install the Device

Refer to the [Safety Instructions](#) (Doc. 6607) prior to installation.

The device can be placed on a flat surface or installed in a rack.

Place on a Flat Surface

Place the device on a flat surface such as a table.

Install in a Rack

This device occupies 1U of rack space.

To install the device in a rack:

1. Use a Phillips screwdriver (not included) to remove the three screws from each side of the device as shown in the illustration.
2. Use the screwdriver and the six screws (removed earlier) to attach the included rack ears to the device.

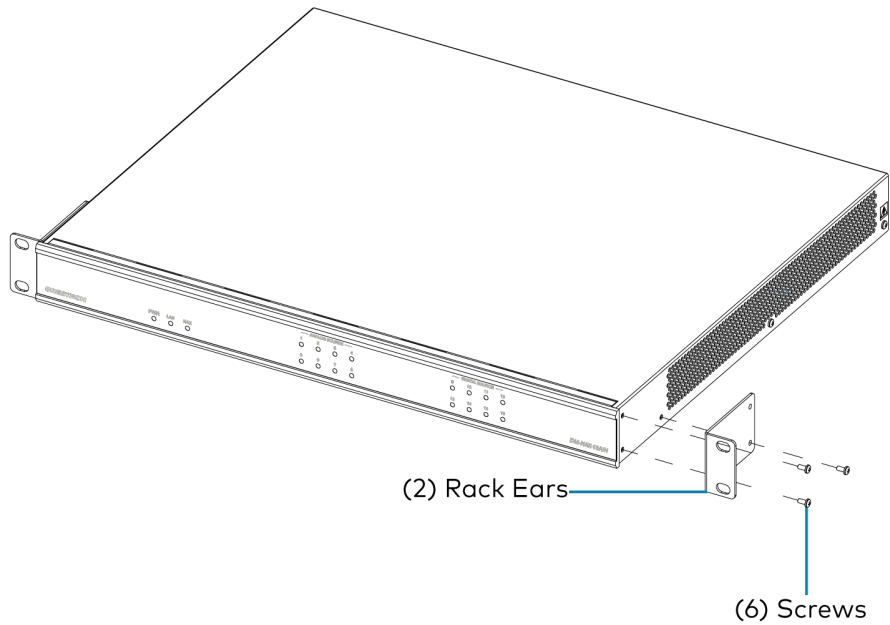

3. Mount the device into the rack using four rack mounting screws (not included).

Rack Mounting Safety Precautions

Elevated Operating Ambient Temperature: If installed in a closed or multi-unit rack assembly, the operating ambient temperature of the rack environment may be greater than the room ambient temperature. Therefore, consideration should be given to installing the equipment in an environment compatible with the maximum ambient temperature (T_{ma}) specified by the manufacturer.

Reduced Airflow: Installation of the equipment in a rack should be such that the amount of airflow required for safe operation of the equipment is not compromised.

Mechanical Loading: Mounting of the equipment in the rack should be such that a hazardous condition is not achieved due to uneven mechanical loading.

Circuit Overloading: Consideration should be given to the connection of the equipment to the supply circuit and the effect that overloading of the circuits might have on overcurrent protection and supply wiring. Appropriate consideration of equipment nameplate ratings should be used when addressing this concern.

Reliable Earthing: Reliable earthing of rack-mounted equipment should be maintained. Particular attention should be given to supply connections other than direct connections to the branch circuit (e.g., use of power strips).

Connect the Device

Make the necessary connections as called out in the following illustration. Connect power last.

CAUTION:

- Keep the device unplugged until all of the input wiring is complete.
- Check the connections for shorts and frayed wiring at all the input connectors.

NOTES:

- Ensure that the unit is properly grounded by connecting the chassis ground lug to an earth ground (building steel).
- To prevent overheating, do not operate this product in an area that exceeds the environmental temperature range of 32° to 104°F (0° to 40°C).
- Do not bundle power cords together with connection cables. Doing so can result in noise.

Rear Panel

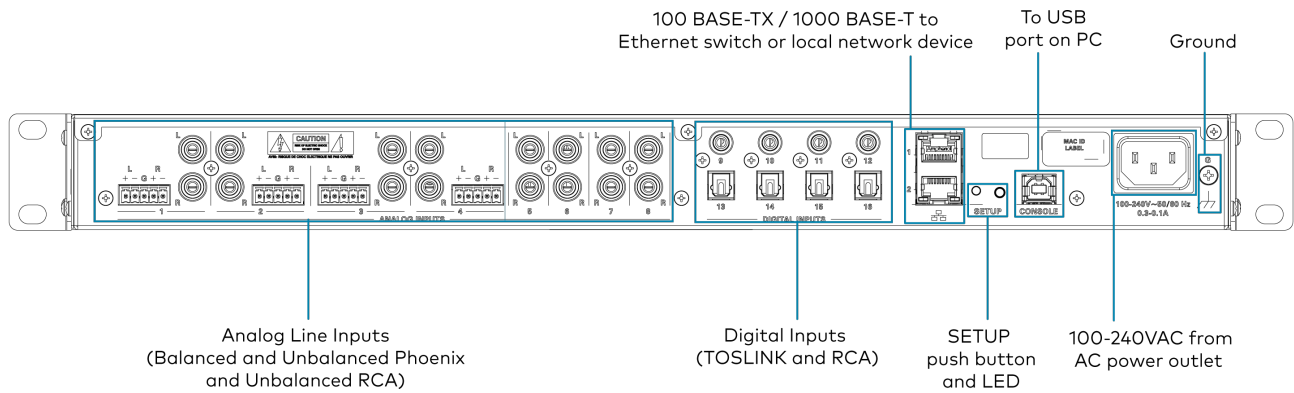

Digital Inputs

Refer to the following illustration when connecting digital audio sources.

Digital Source —  COAXIAL Connector

Digital Source —  TOSLINK® Connector

NOTE: 2-channel PCM digital audio is the only supported digital input format.

Analog Inputs

Refer to the following illustration when connecting analog audio sources.

Stereo Source Left —  RCA Connector

Stereo Source Right —  RCA Connector

Balanced/Unbalanced Audio Input

Refer to the following table and illustration for analog audio input pin assignments and connection information.

Signal Name	Balanced Audio Input	Unbalanced Audio Input
+	L+	L+
-	L-	Open
G	Shield/ground	Open
+	R+	R+
-	R-	Open

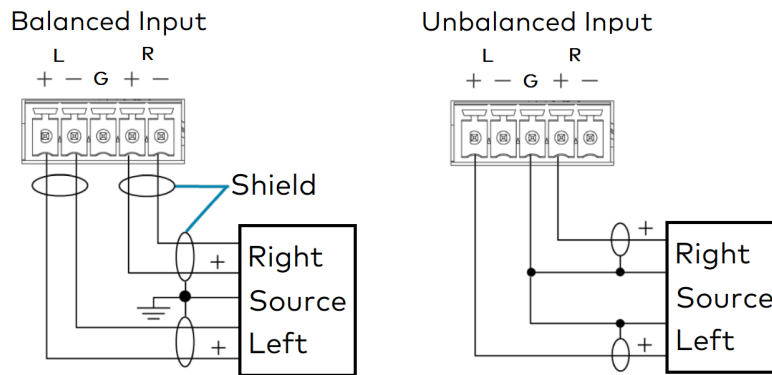

Observe the LED Indicators

Refer to the following table for information about the LED indicators on the device.

LED Indicator	Color	Meaning
PWR	Amber	Power is being applied to the device. The device is booting.
	White	Device is powered on with audio passing.
	Red	Device is in standby mode.
LAN	White	The device is powered on and has a valid IP address.
	Off	Device is not connected to a network or the IP address is invalid.
NAX	White	AoIP is ready to pass and the unit's PTP clock is synced.
	Off	No AoIP is passing to or from and/or PTP is not synced.
SOURCE 1-16	White	Signal is detected on the specified input/source.
	Red	There is clipping on an analog input or bitstream audio detected on a digital input.
	Off	There is no signal detected on the specified input/source.

LED Indicator	Color	Meaning
SETUP	Solid Red	The SETUP button is pressed.
	Blinking Red	A network reset or factory restore has been initiated via the adjacent SETUP button.

Reset the Device

A network reset or factory restore may be performed when troubleshooting.

CAUTION: These procedures should only be performed as a last resort to recover an unresponsive device. Both the Network Reset and Factory Restore procedure will clear certain device settings that cannot be recovered once the procedure is complete. Before performing these procedures, please contact Crestron True Blue Support via phone, email or chat as described at www.crestron.com/support.

Network Reset

1. Ensure the device is powered on.
2. Press and hold the **SETUP** button for up to 15 seconds until the **SETUP** LED flashes red.

The device will reboot, and the default network settings will be reset. The device will be reverted to its default hostname, with DHCP enabled, and no static IP set.

Factory Restore

1. Turn off the device by disconnecting the power cable from the device.
2. Press and hold the **SETUP** button and then reconnect the power cable while still holding the **SETUP** button. Continue holding the **SETUP** button for up to 30 seconds until the **SETUP** LED flashes.

The device will reboot, and all the factory default settings will be restored, such as Zone settings, names, multicast addressing, etc.

CAUTION: Performing a factory restore will clear all settings from the device configuration.

DM-NAX-AMP-X300 Installation

Refer to the following sections to install the DM-NAX-AMP-X300.

- [In the Box on page 102](#)
- [Install the Device on page 103](#)
- [Connect the Device on page 107](#)
- [Speaker Mode Selection Switch on page 107](#)
- [Lo-Z Modes Selection Switch on page 108](#)
- [Observe the LED Indicators on page 108](#)
- [Reset the Device on page 109](#)

In the Box

Qty. Description

1 DM-NAX-AMP-X300

Additional Items

- 4 Plate, Joining (2055198)
- 8 Screw, 8-32 x 5/16 in., Flat Head, Philips, Black (2055195)
- 4 Screw, 6-32 x 3/8 in., Undercut Head, Philips (2055196)
- 4 Foot, Adhesive, Black (2055200)
- 2 Rack Ear Assembly, 1U, Quarter-width (2055197), includes Bracket, Rack Ear, 1U (2055199)
- 2 Connector, Speaker (2055026)
- 8 Connector, input, output (2055207)
- 1 Connector, 2-Pin (2003574)
- 1 Power cord (2055205)

Install the Device

The DM-NAX-AMP-X300 can be placed or mounted on a flat surface or installed in a rack.

Place on a Flat Surface

Place the DM-NAX-AMP-X300 on a table or other flat surface. Attach the four adhesive feet as shown below.

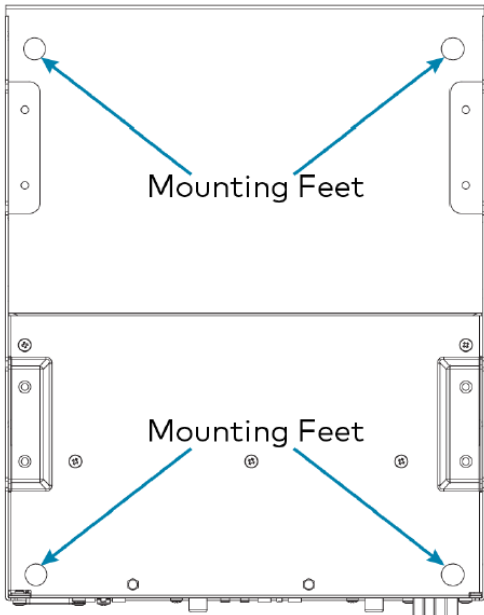

Mount on a Flat Surface

To mount the DM-NAX-AMP-X300 on a flat surface:

1. Use the eight included 8-32 x 5/16 in. screws to attach the four joining plates to the underside of the device as shown in the illustration.

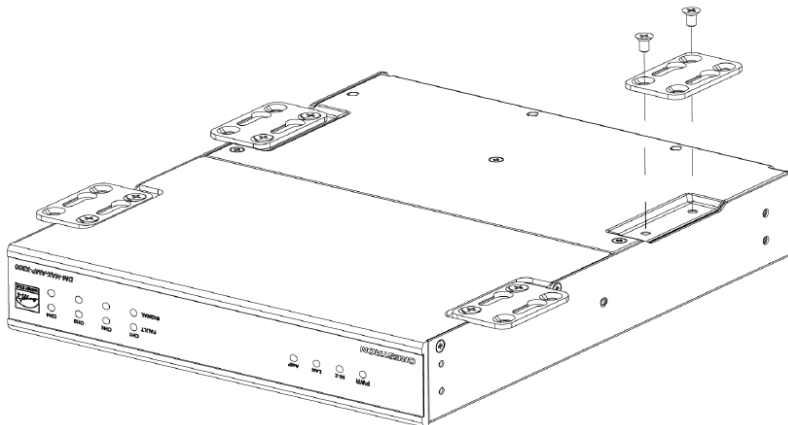

2. Position the device as desired and use screws (not included) and anchors (not included) to mount it.

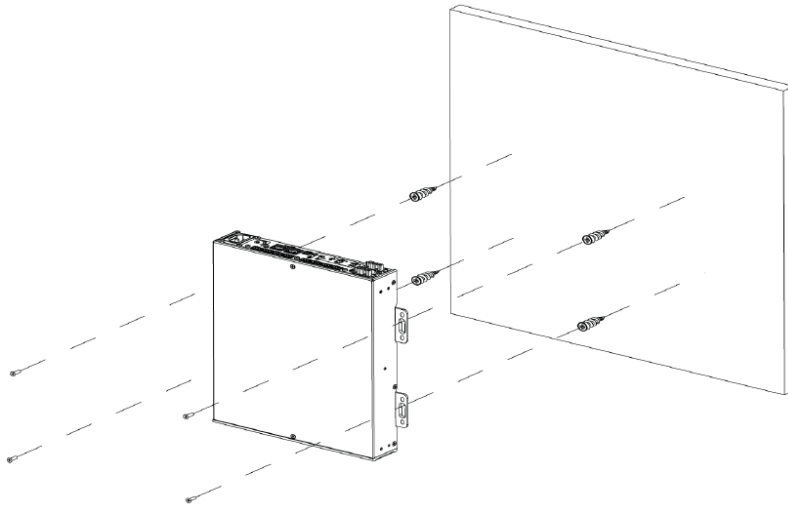

Rack Installation

The DM-NAX-AMP-X300 occupies one half of 1RU of rack space. Two DM-NAX-AMP-X300 units can be placed together and only occupy 1 RU of rack space.

Single Amp

To install the included rack ears on a single DM-NAX-AMP-X300:

1. Use a #1 Philips screwdriver to remove the three screws from each side of the front of the device.
2. Use the screwdriver and the four included 1/4 in. Philips Pan Head screws to attach the included rack ears to the device.

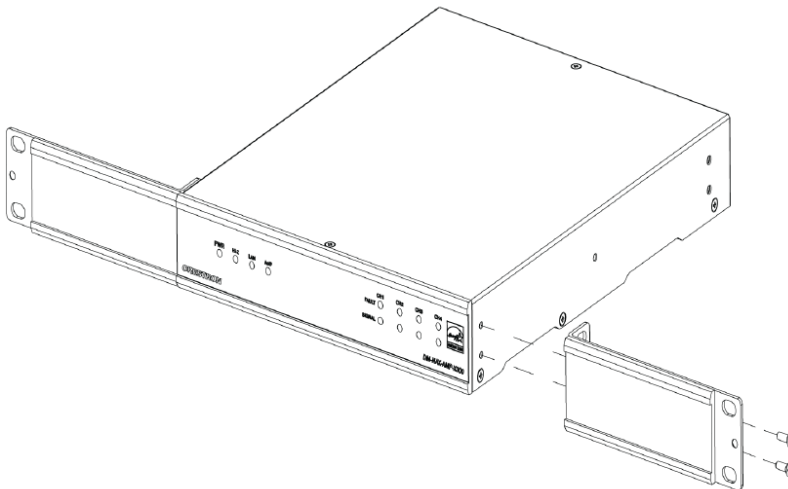

3. Mount the device into the rack using four rack mounting screws (not included).

Double Mount

To rack-mount two DM-NAX-AMP-X300 units together:

1. On a flat surface, place the amplifiers upside-down and adjacent to each other.
2. Using a Philips screwdriver and the eight included 8-32 x 5/16 in. screws, gang the amplifiers together with two of the joining plates.

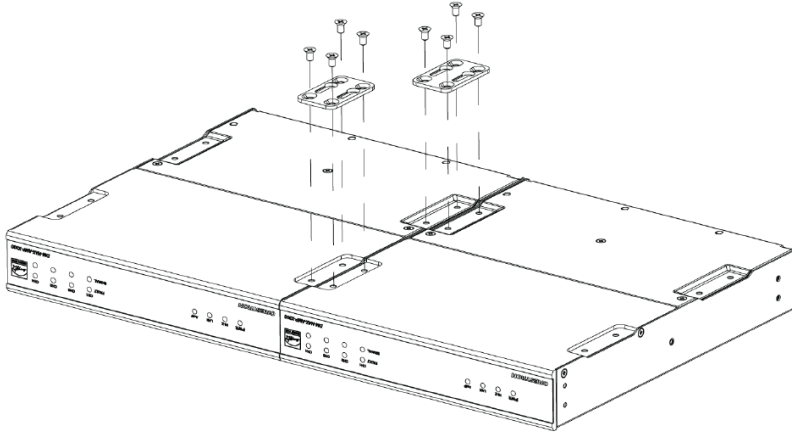

3. Use a wrench or M5.5 socket to remove the nuts from the rack ears.

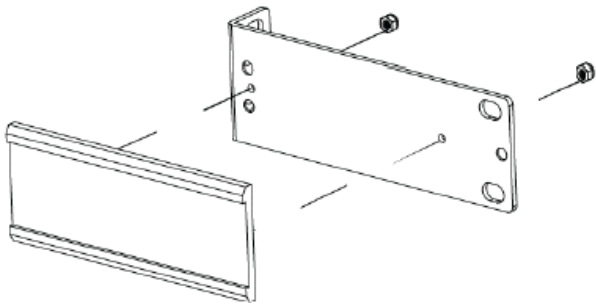

4. Turn the amplifier assembly over and, using six 6-32 x 3/8 in. screws, attach the rack ears to each side.

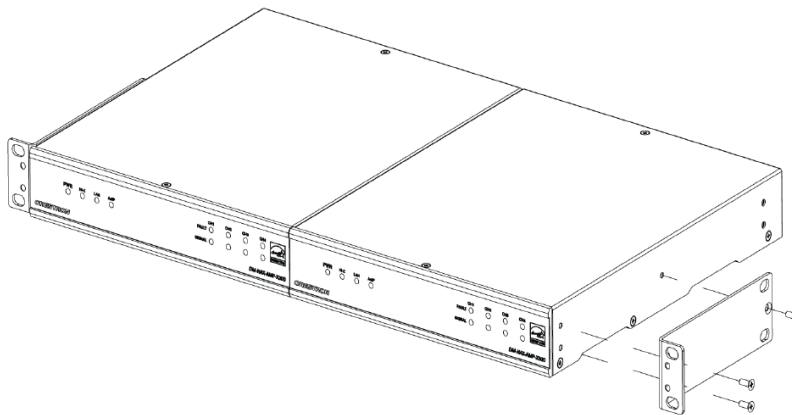

5. Mount the assembly into the rack using four rack mounting screws (not included).

NOTE: Observe the following rack mount installation guidelines.

Elevated Operating Ambient Temperature: If installed in a closed or multi-unit rack assembly, the operating ambient temperature of the rack environment may be greater than room ambient temperature. Therefore, consideration should be given to installing the equipment in an environment compatible with the maximum ambient temperature (T_{ma}) specified by the manufacturer.

Reduced Airflow: Installation of the equipment in a rack should be such that the amount of airflow required for safe operation of the equipment is not compromised.

Mechanical Loading: Mounting of the equipment in the rack should be such that a hazardous condition is not achieved due to uneven mechanical loading.

Circuit Overloading: Consideration should be given to the connection of the equipment to the supply circuit and the effect that overloading of the circuits might have on overcurrent protection and supply wiring. Appropriate consideration of equipment nameplate ratings should be used when addressing this concern.

Reliable Earthing: Reliable earthing of rack-mounted equipment should be maintained. Particular attention should be given to supply connections other than direct connections to the branch circuit (e.g., use of power strips).

WARNING: To prevent bodily injury when mounting or servicing the unit in a rack:

- When mounting the unit into a partially filled rack, load the rack from the bottom to the top with the heaviest component at the bottom of the rack.
- If the rack is provided with stabilizing devices, install the stabilizers before mounting or servicing the unit in the rack.

Connect the Device

Make the necessary connections as called out in the following illustration. For details on wiring, refer to [Output Wiring Options on page 110](#).

CAUTION:

- Keep the device unplugged until all of the input, network, output, and speaker wiring is complete.
- Check the speaker cables for shorts and frayed wiring around the speaker output connectors.

NOTES:

- Ensure that the unit is properly grounded by connecting the chassis ground lug to an earth ground (building steel).
- To prevent overheating, do not operate this product in an area that exceeds the environmental temperature range listed in the table of specifications.
- Ensure that both the Ethernet ports are not connected to the same network or switch.

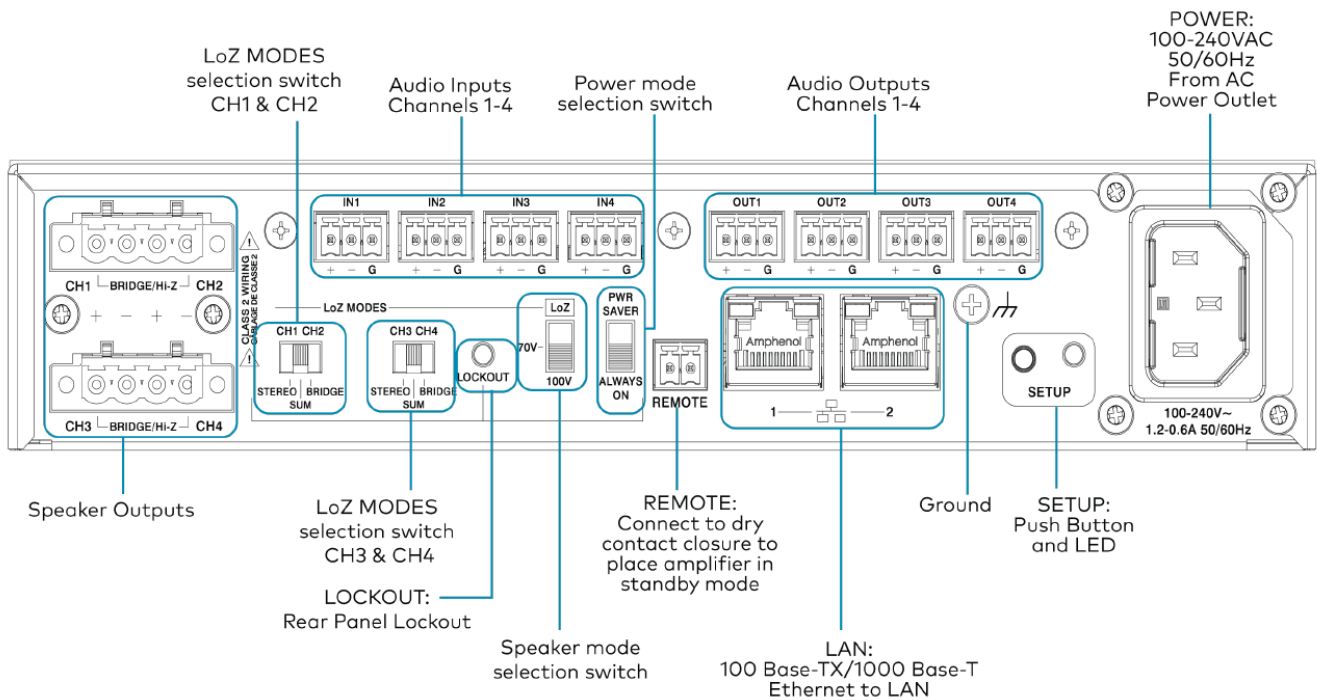

Speaker Mode Selection Switch

The DM-NAX-AMP-X300 can be configured to work with 4 Ω and 8 Ω (low impedance or Lo-Z) loads or a distributed audio (high impedance or Hi-Z) 70/100V system.

- **Lo-Z:** Set the switch to LoZ to use the amplifier with 4 Ω or 8 Ω low impedance loudspeakers.
- **70V:** Set the switch to 70V to use the amplifier in a 70V distributed audio system.
- **100V:** Set the switch to 100V to use the amplifier in a 100V distributed audio system.

Lo-Z Modes Selection Switch

When operating in Lo-Z mode, the DM-NAX-AMP-X300 outputs can operate in stereo, as summed outputs or as bridged outputs. Set the **Lo-Z Modes** selection switch to the desired setting and connect the outputs as required.

Select stereo, summed, or bridged operation:

- **STEREO:** The input signal received on each channel is sent to its respective output for use in applications where left and right channel separation is required.
- **SUM:** The input signals sent to a channel pair (1 + 2 or 3 + 4) are summed and sent to their respective individual outputs.
- **BRIDGE:** The input signals sent to a channel pair (1 + 2 or 3 + 4) are summed and sent to a bridged output (1 + 2 or 3 + 4) for use in high power applications.

NOTE:

- If the Rear Panel Lockout indicator is enabled, the web user interface settings will override the both switch selections.

Observe the LED Indicators

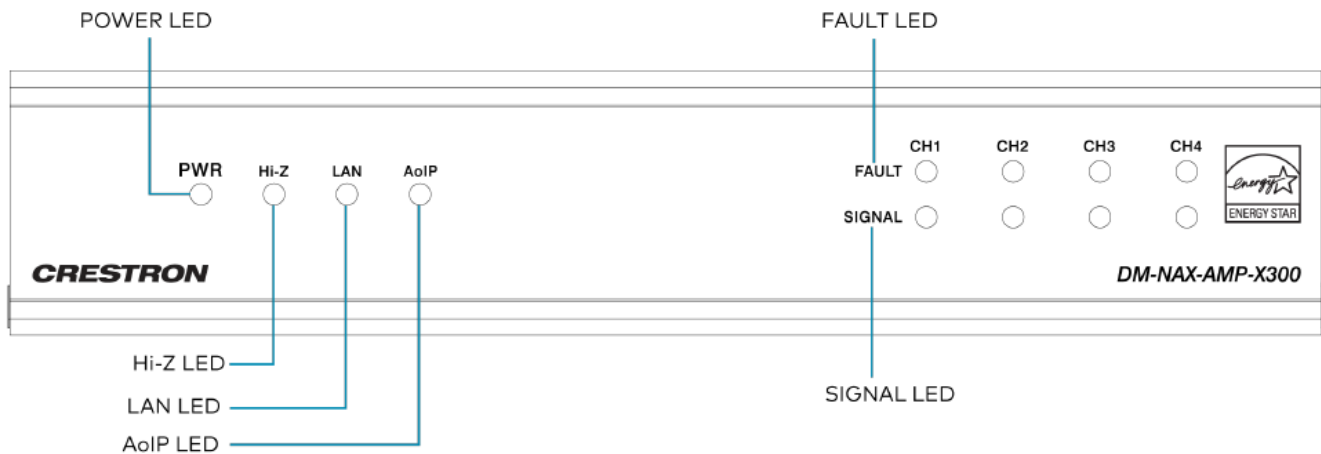

The LEDs provide the following information:

LED Indicator	Color	Meaning
PWR	White	The device is operating normally.
	Amber	The device is booting.
	Red	The device has entered Standby (Power Saver) mode.
Hi-Z	White	Hi-Z mode is enabled (70V or 100V); Channels 1-2 and 3-4 are bridged and set to 70V or 100V operation.
LAN	White	The device has a valid IP address.
AoIP	White	The device has is handling an AoIP stream.
FAULT	Red	There is a fault on the indicated channel.
SIGNAL	White	An audio signal is present on the indicated speaker channel.
	Red	Clipping is detecting on the indicated speaker channel.

Reset the Device

A network reset or factory restore may be performed when troubleshooting.

CAUTION: These procedures should only be performed as a last resort to recover an unresponsive device. Both the Network Reset and Factory Restore procedure will clear certain device settings that cannot be recovered once the procedure is complete. Before performing these procedures, please contact Crestron True Blue Support via phone, email or chat as described at www.crestron.com/support.

Network Reset

1. Ensure the device is powered on.
2. Press and hold the **SETUP** button for up to 15 seconds until the **SETUP** LED flashes red.

Factory Restore

To restore all settings to factory default, perform the following steps:

1. Turn off the device by disconnecting the power cable from the device.
2. Press and hold the **SETUP** button and then reconnect the power cable while still holding the **SETUP** button. Continue holding the **SETUP** button for up to 30 seconds until the **SETUP** LED flashes.

The device will reboot, and all the factory default settings will be restored, such as Zone settings, names, multicast addressing, etc.

CAUTION: Performing a factory restore will clear all settings from the device configuration.

Output Wiring Options

The DM-NAX-AMP-X300 can be configured for low impedance (LoZ) stereo operation over two or four channels and high impedance (70 V or 100 V) operation over two channels. Refer to the following diagrams for details.

Four Channels up to 75 W (Lo-Z)

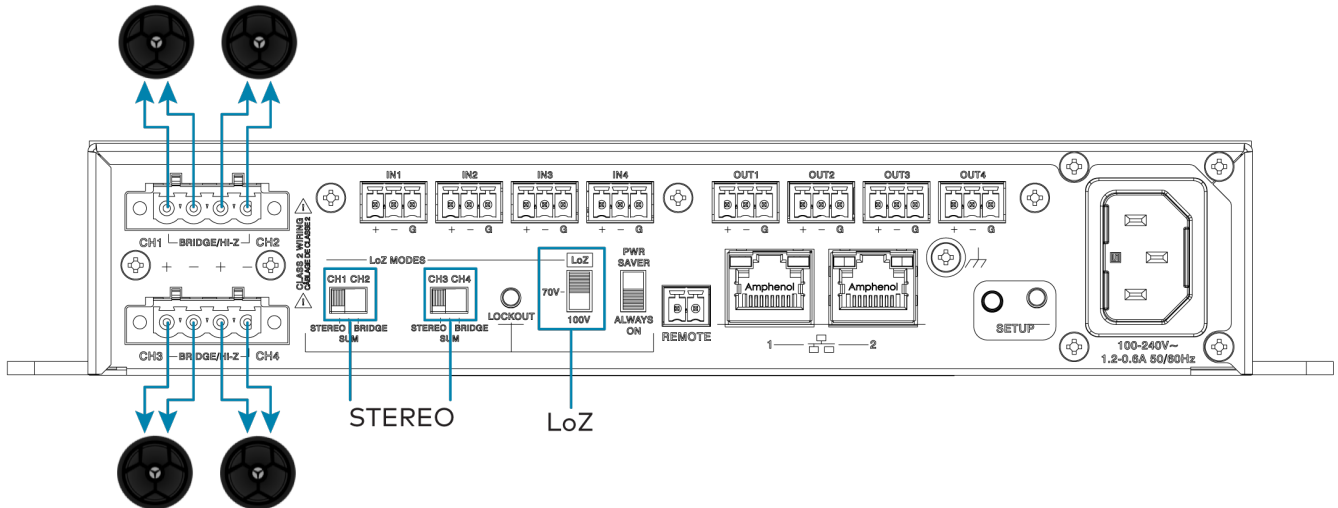

Two Channels up to 150 W (Lo-Z)

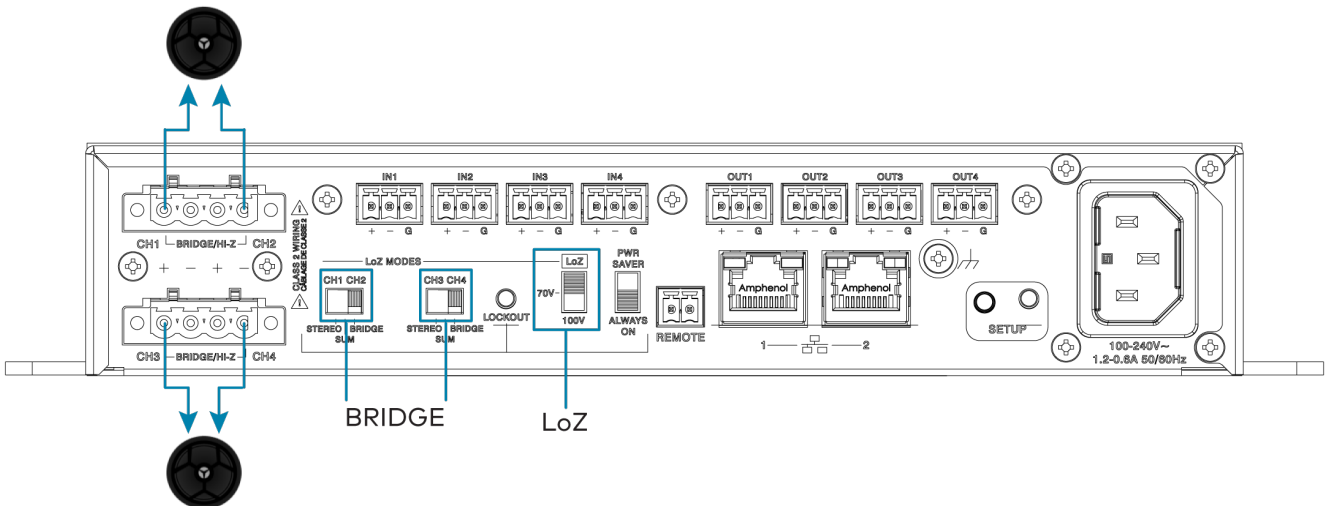

Two Channels up to 75 W and One Channel up to 150 W (Lo-Z)

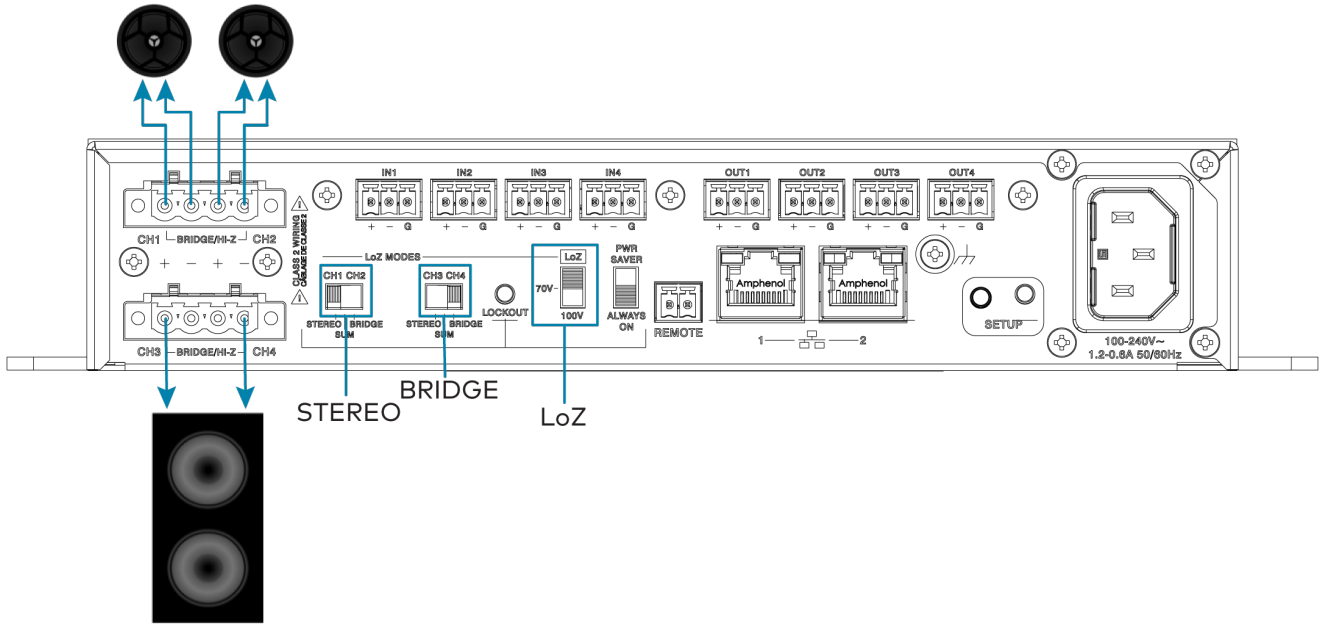

One Channel up to 300 W (Lo-Z)

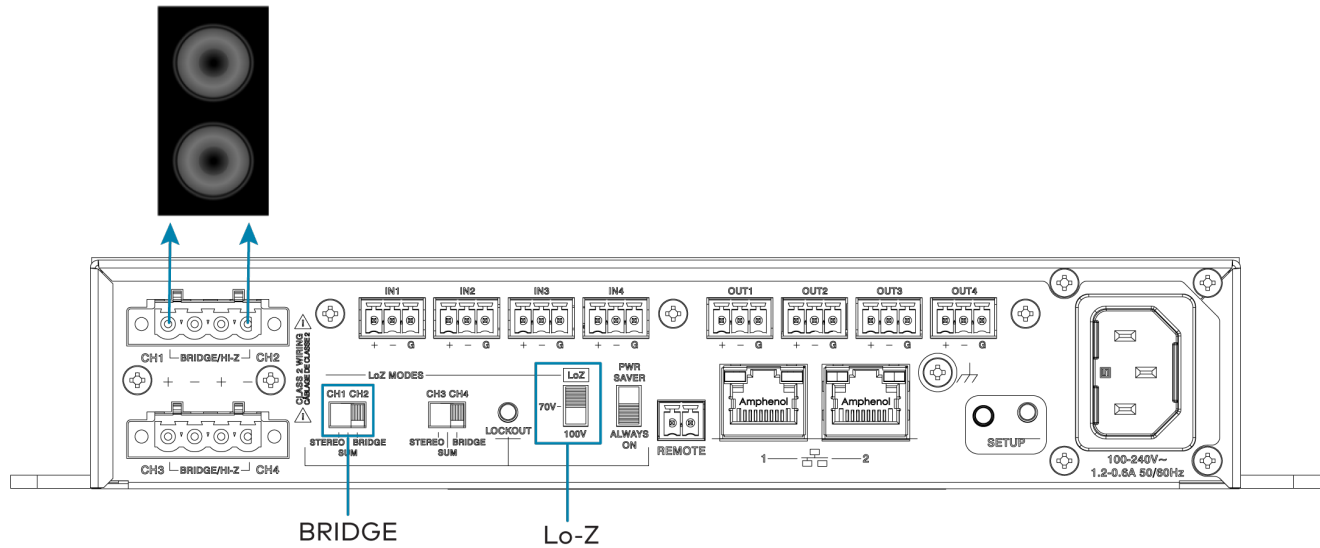

Two Runs up to 150 W (Hi-Z)

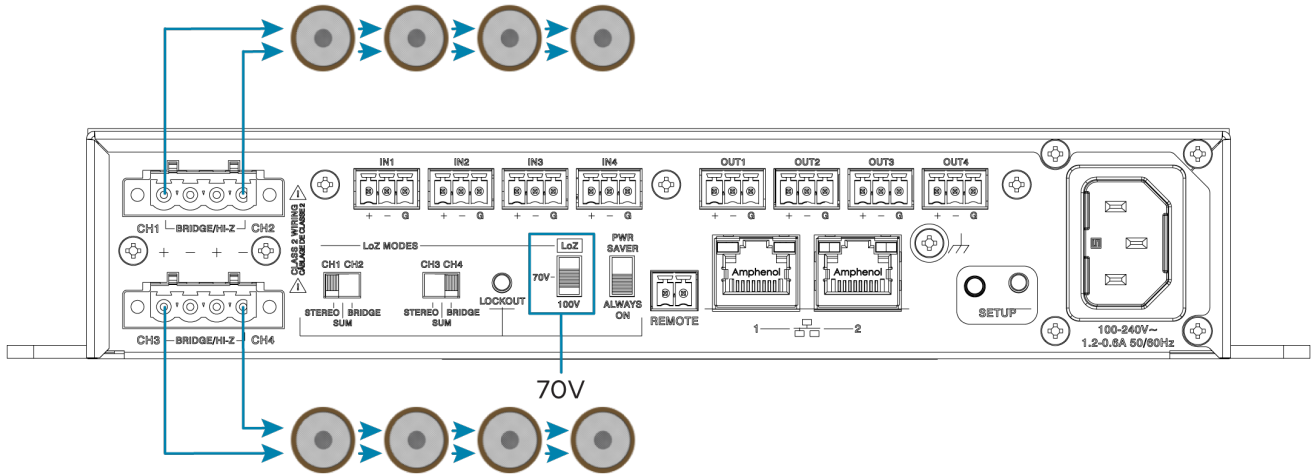

One Run up to 300 W (Hi-Z)

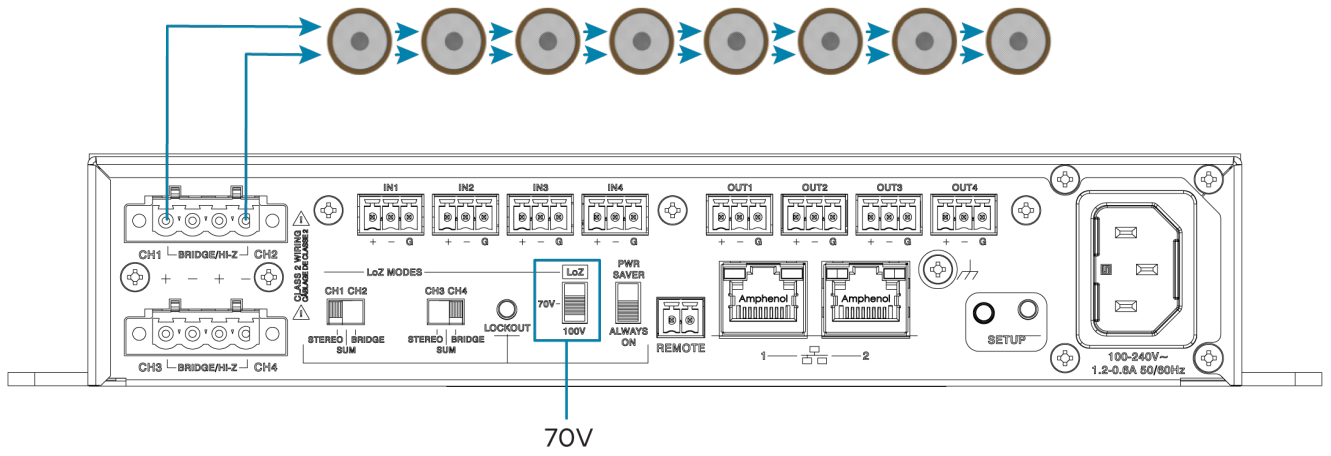

DM-NAX-AUD-IO Installation

Refer to the following sections to install the DM-NAX-AUD-IO.

- [In the Box on page 113](#)
- [Mount the Device on page 113](#)
- [Connect the Device on page 118](#)
- [Reset the Device on page 119](#)

In the Box

Qty. Description

1 DM-NAX-AUD-IO

Additional Items

- 1 Single gang electrical box adapter bracket, galvanized metal (2059673)
- 2 Surface mount bracket, aluminum (2059674)
- 2 Connector, 5-pin (2003577)
- 2 Screws, M3 x 6 mm, Flat Head, Phillips (2062526)
- 4 Screws, M3 x 0.5 x 6 mm, Pan Head, Phillips (2058870)
- 1 Polycarbonate front panel label (4536923)

Mount the Device

The DM-NAX-AUD-IO can be mounted under a table, into a 1-gang electrical box, or onto a rack rail.

Mounting under a Table

To mount the device under a table:

1. Using a Phillips screwdriver, remove the four flat head screws from the left and right panels of the device.
2. Align the two included right angle surface mount brackets with the left and right panels of the device. For mounting under a table, keep the flanged surface of the brackets flush with the top panel of the device. For mounting to a surface, keep the flanged surface of the brackets flush with the bottom panel of the device.

- Using a Phillips screwdriver and the four included M3 pan head screws, attach the mounting brackets to the device.

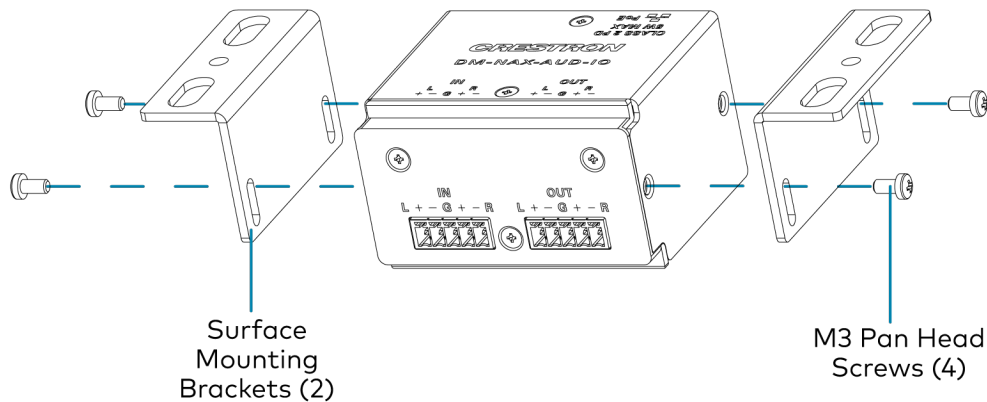

- Secure the device to a surface or under a table using the appropriate mounting screws (not included).

Mounting into a 1-Gang Electrical Box

NOTES:

- The DM-NAX-AUD-IO should only be mounted with a RACO® 3 in. x 2 in. x 2 in. gangable metal switch box with eight 0.5 in. knockouts and plaster ears (catalog ID #420), as it was designed to fit the box dimensions and knockout placements. Alternative metal switch boxes should not be used as they may have different knockout placements, which can lead to issues running the PoE connection to the unit due to cable bend radius restrictions.
- For thermal performance reasons, fully enclosed plastic back boxes should not be used with the DM-NAX-AUD-IO. In installations where an enclosed back box is not required, the DM-NAX-AUD-IO can be installed into most single gang metal or plastic mud rings.
- Connector boots should not be used on CAT5e (or greater) cables being connected to the DM-NAX-AUD-IO to avoid cable bend radius issues.

To mount the device into a 1-gang electrical box:

- Using a Phillips screwdriver, remove the two screws from the top and bottom panels nearer to the front panel of the device.
- Align the included polycarbonate front panel label with the front panel of the device so the holes in the label line up with the 5-pin connectors.

- Using a Phillips screwdriver and the included M3 flat head screws, secure the included single gang electrical box adapter bracket to the top and bottom panels of the device.

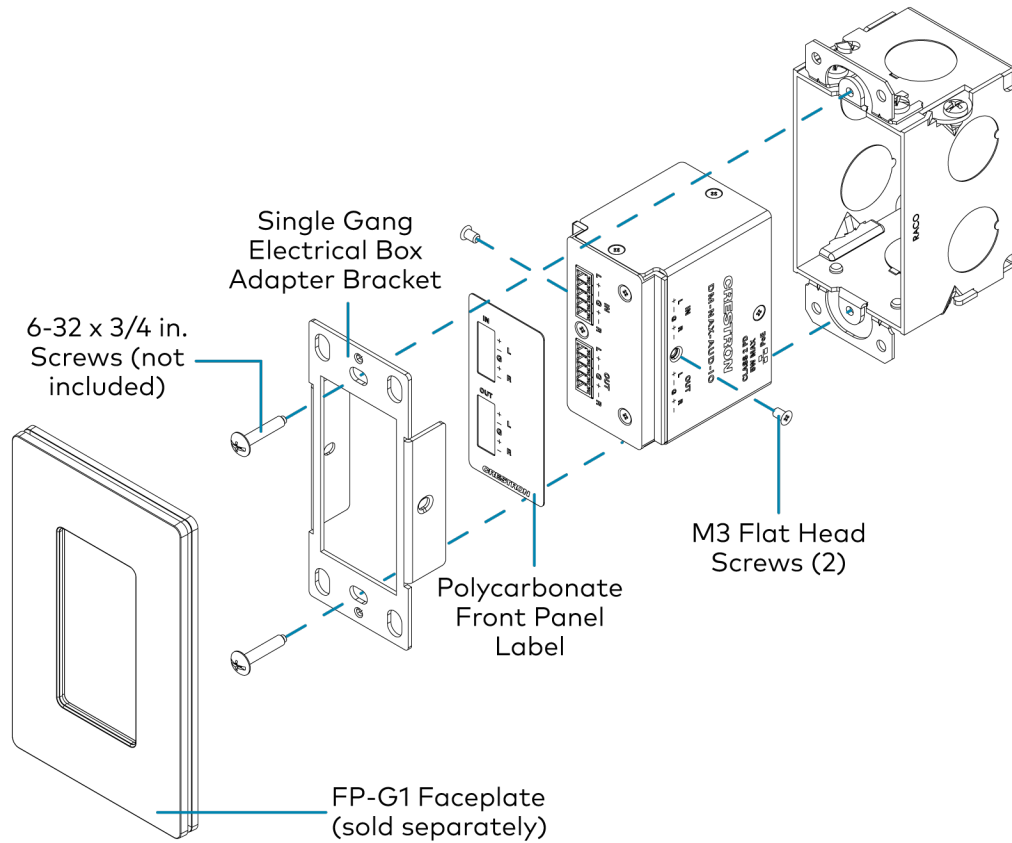

- Using a Phillips screwdriver and two 6-32 x 3/4 in., truss head screws (not included), attach the wall plate adapter bracket to the electrical box.
- Using a Phillips screwdriver and two 6-32 x 1/4 in., flat head screws (not included), attach a [FP-G1](#) decorator style faceplate (sold separately) to the wall plate.

Mounting onto a Rack Rail

To mount the device onto a rack rail:

- Using a Phillips screwdriver, remove the two screws from the top and bottom panels nearer to the front panel of the device.

- Using a Phillips screwdriver and the included M3 flat head screws, secure the included single gang electrical box adapter bracket to the top and bottom panels of the device.

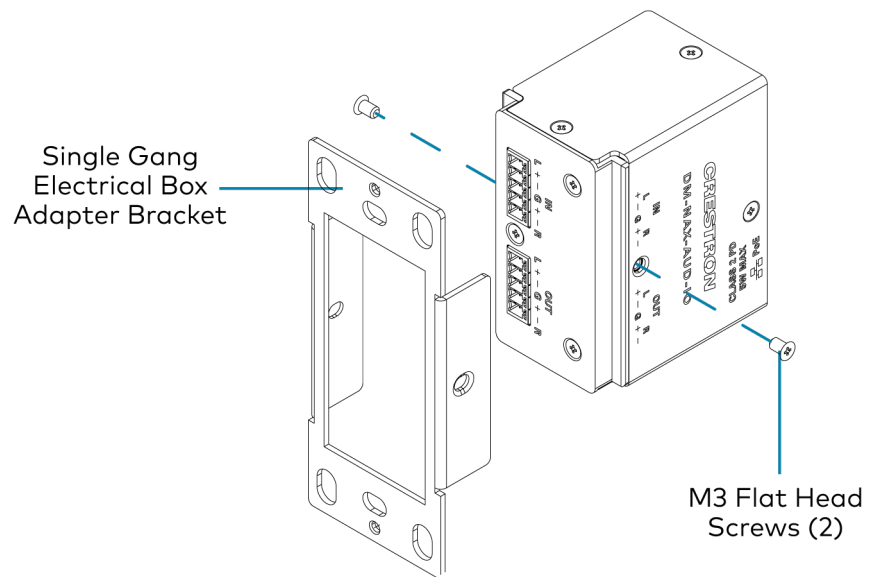

- Position the wall plate horizontally so that the holes in the left or right mounting flange align with the holes in the rack rail.

4. Secure the wall plate to the rack rail using two mounting screws (not included).

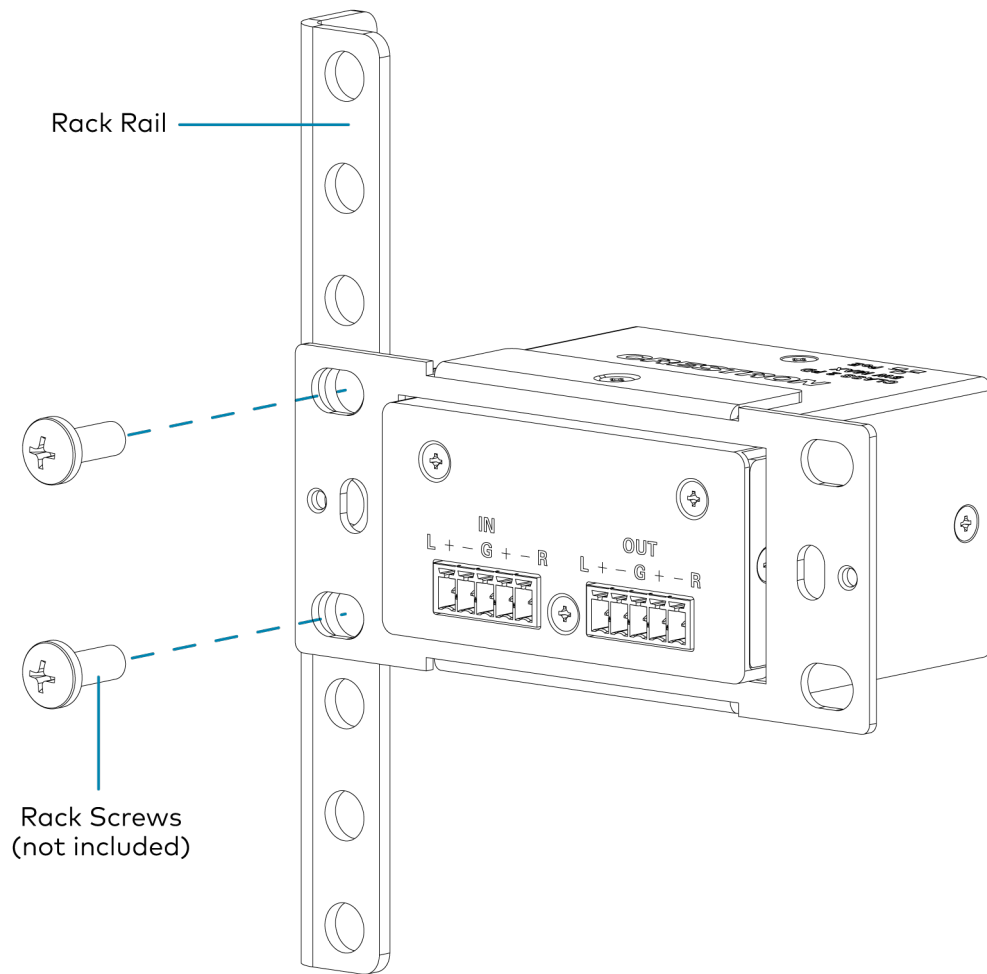

Connect the Device

Make connections to the front and rear panels of the DM-NAX-AUD-IO:

Rear Panel

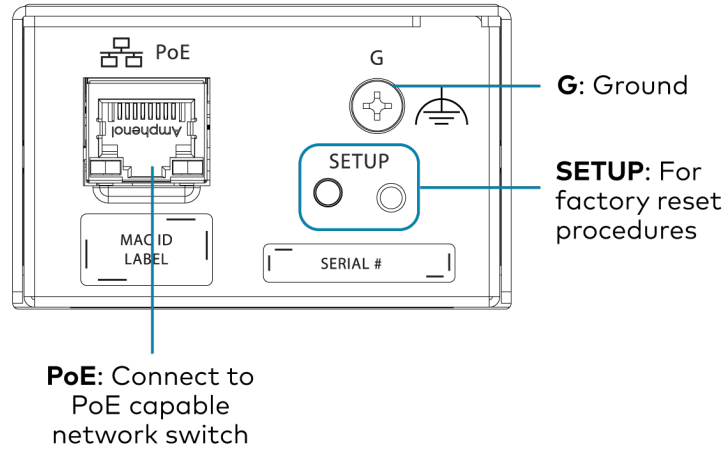

NOTE: **PoE** is a PoE powered device (PD) port. In order for the port to receive PoE, it must be connected to a PoE compliant Ethernet switch.

Connect a PoE capable network switch to the **PoE** port.

Front Panel

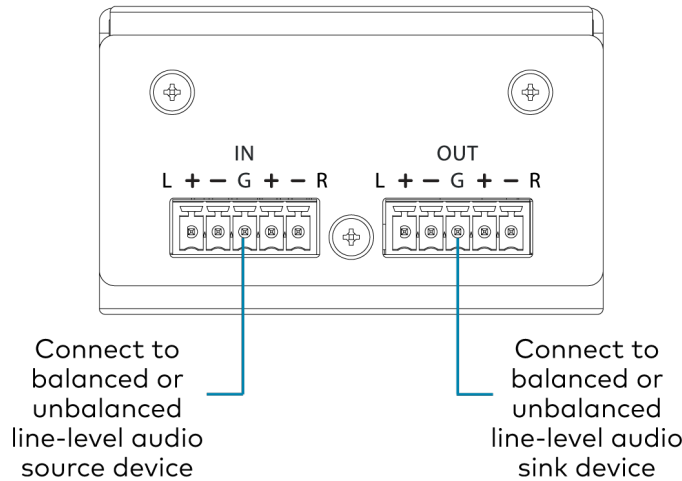

Connect a balanced or unbalanced line-level audio source signal to the **INPUTS** 5-pin terminal block.

Connect a balanced or unbalanced line-level audio sink device to the **OUTPUTS** 5-pin terminal block.

Balanced/Unbalanced Audio Input

Refer to the following table and illustration for analog audio input pin assignments and connection information.

Signal Name	Balanced Audio Input	Unbalanced Audio Input
+	L+	L+
-	L-	Open
G	Shield/ground	Open
+	R+	R+
-	R-	Open

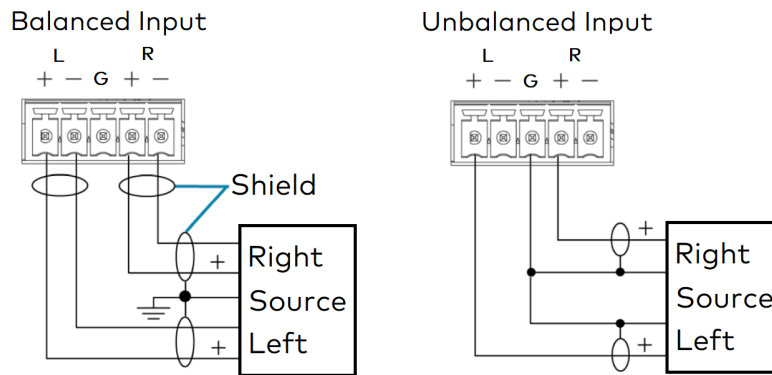

Reset the Device

A network reset or factory restore may be performed when troubleshooting.

CAUTION: These procedures should only be performed as a last resort to recover an unresponsive device. Both the Network Reset and Factory Restore procedure will clear certain device settings that cannot be recovered once the procedure is complete. Before performing these procedures, please contact Crestron True Blue Support via phone, email or chat as described at www.crestron.com/support.

Network Reset

1. Ensure the device is powered on.
2. Press and hold the **SETUP** button for up to 15 seconds until the **SETUP** LED flashes red.

The device will reboot, and the default network settings will be reset. The device will be reverted to its default hostname, with DHCP enabled, and no static IP set.

Factory Restore

1. Turn off the device by disconnecting the power cable from the device.
2. Press and hold the **SETUP** button and then reconnect the power cable while still holding the **SETUP** button. Continue holding the **SETUP** button for up to 30 seconds until the **SETUP** LED flashes.

The device will reboot, and all the factory default settings will be restored, such as audio settings, multicast addressing, etc.

CAUTION: Performing a factory restore will clear all settings from the device configuration.

DM-NAX-AUD-USB Installation

Refer to the following sections to install the DM-NAX-AUD-USB.

- [In the Box on page 121](#)
- [Mount the Device on page 121](#)
- [Connect the Device on page 126](#)
- [Reset the Device on page 127](#)

In the Box

Qty. Description

1 DM-NAX-AUD-USB

Additional Items

- 1 Single gang electrical box adapter bracket, galvanized metal (2059673)
- 2 Surface mount bracket, aluminum (2059674)
- 2 Screws, M3 x 6 mm, Flat Head, Phillips (2062526)
- 4 Screws, M3 x 0.5 x 6 mm, Pan Head, Phillips (2058870)
- 1 Polycarbonate front panel label (4536924)

Mount the Device

The DM-NAX-AUD-USB can be mounted under a table, into a 1-gang electrical box, or onto a rack rail.

Mounting under a Table

To mount the device under a table:

1. Using a Phillips screwdriver, remove the four flat head screws from the left and right panels of the device.
2. Align the two included right angle surface mount brackets with the left and right panels of the device. For mounting under a table, keep the flanged surface of the brackets flush with the top panel of the device. For mounting to a surface, keep the flanged surface of the brackets flush with the bottom panel of the device.

- Using a Phillips screwdriver and the four included M3 pan head screws, attach the mounting brackets to the device.

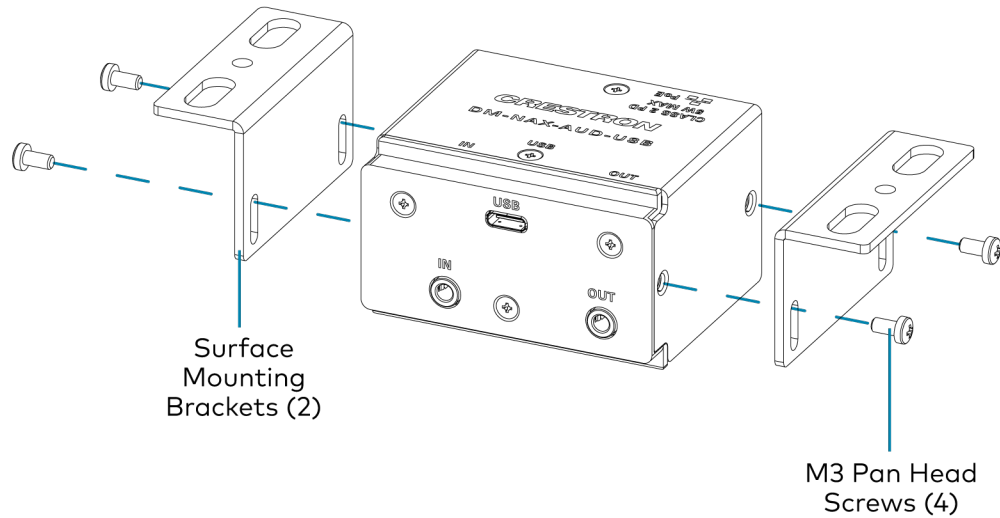

- Secure the device to a surface or under a table using the appropriate mounting screws (not included).

Mounting into a 1-Gang Electrical Box

NOTES:

- The DM-NAX-AUD-USB should only be mounted with a RACO® 3 in. x 2 in. x 2 in. gangable metal switch box with eight 0.5 in. knockouts and plaster ears (catalog ID #420), as it was designed to fit the box dimensions and knockout placements. Alternative metal switch boxes should not be used as they may have different knockout placements, which can lead to issues running the PoE connection to the unit due to cable bend radius restrictions.
- For thermal performance reasons, fully enclosed plastic back boxes should not be used with the DM-NAX-AUD-USB. In installations where an enclosed back box is not required, the DM-NAX-AUD-USB can be installed into most single gang metal or plastic mud rings.
- Connector boots should not be used on CAT5e (or greater) cables being connected to the DM-NAX-AUD-USB to avoid cable bend radius issues.

To mount the device into a 1-gang electrical box:

- Using a Phillips screwdriver, remove the two screws from the top and bottom panels nearer to the front panel of the device.
- Align the included polycarbonate front panel label with the front panel of the device so the holes in the label line up with the 5-pin connectors.

- Using a Phillips screwdriver and the included M3 flat head screws, secure the included single gang electrical box adapter bracket to the top and bottom panels of the device.

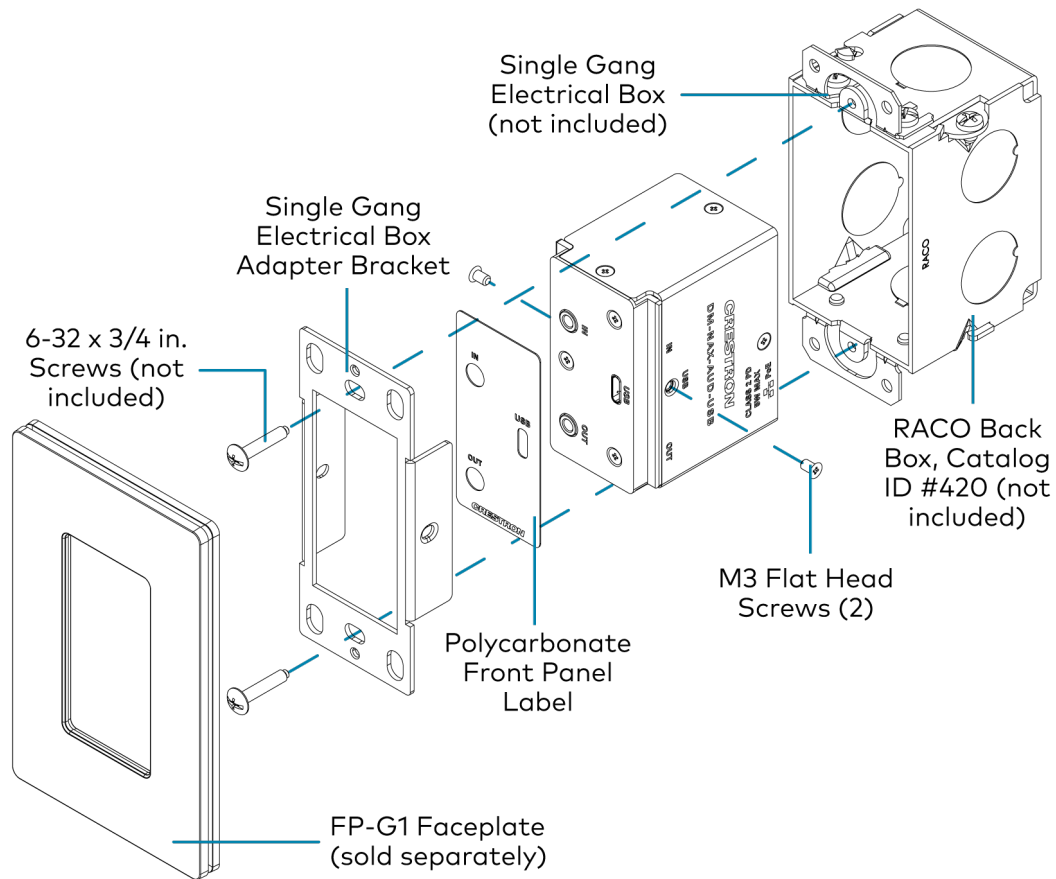

- Using a Phillips screwdriver and two 6-32 x 3/4 in., truss head screws (not included), attach the wall plate adapter bracket to the electrical box.
- Using a Phillips screwdriver and two 6-32 x 1/4 in., flat head screws (not included), attach a [FP-G1](#) decorator style faceplate (sold separately) to the wall plate.

Mounting onto a Rack Rail

To mount the device onto a rack rail:

- Using a Phillips screwdriver, remove the two screws from the top and bottom panels nearer to the front panel of the device.

2. Using a Phillips screwdriver and the included M3 flat head screws, secure the included single gang electrical box adapter bracket to the top and bottom panels of the device.

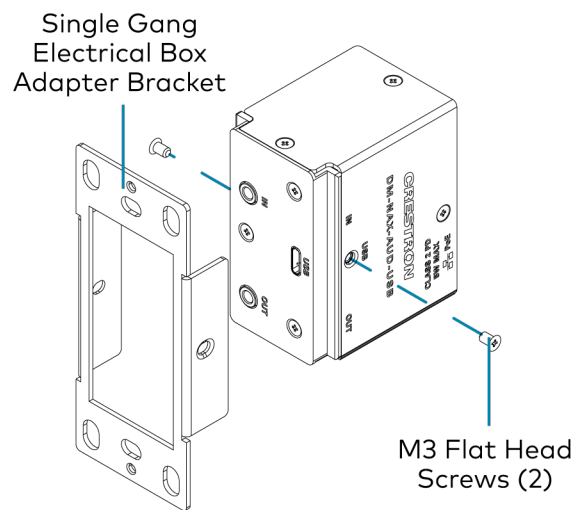

3. Position the wall plate horizontally so that the holes in the left or right mounting flange align with the holes in the rack rail.

4. Secure the wall plate to the rack rail using two mounting screws (not included).

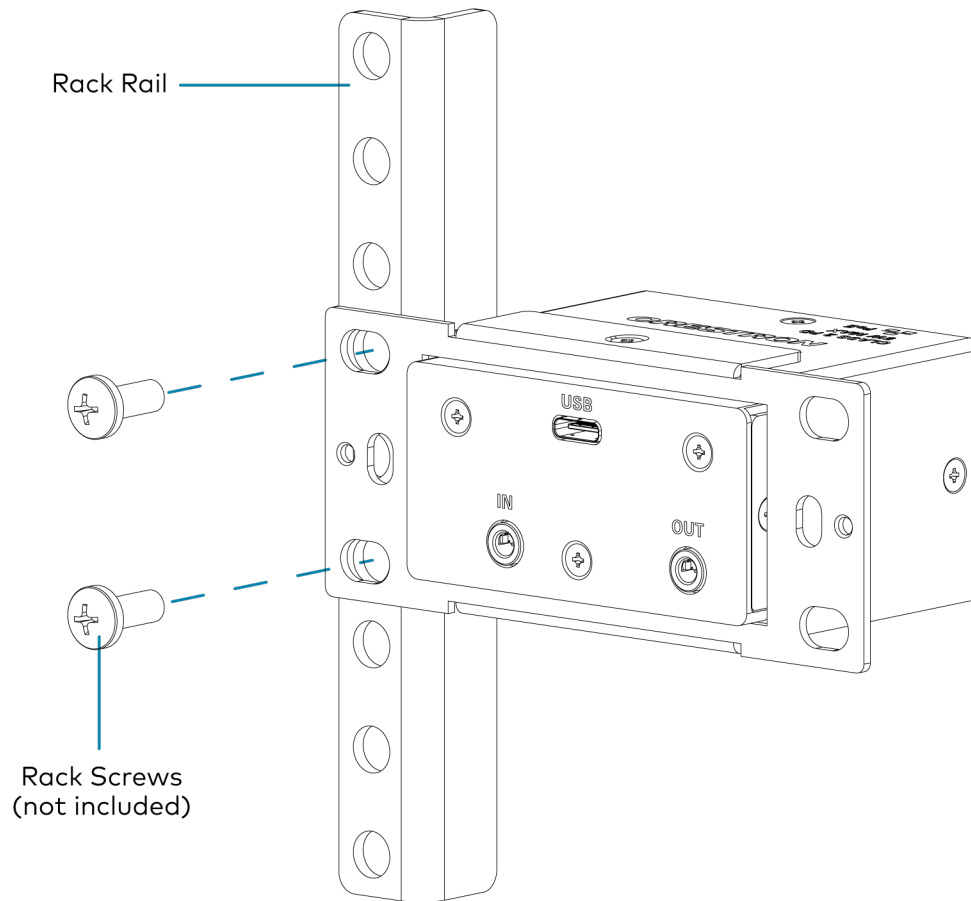

Connect the Device

Make connections to the front and rear panels of the DM-NAX-AUD-USB:

Rear Panel

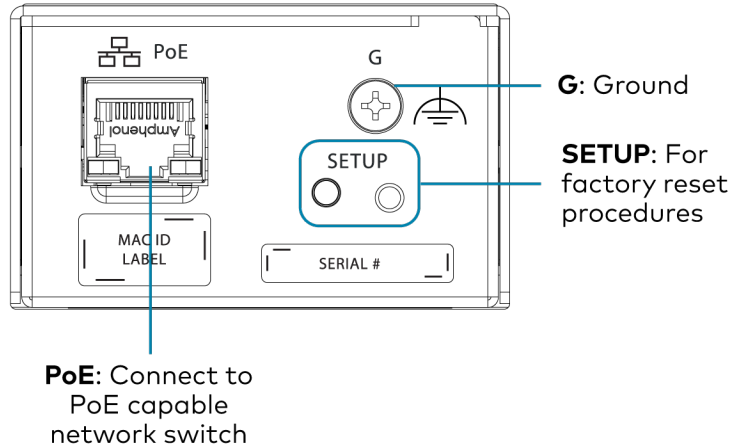

NOTE: PoE is a PoE powered device (PD) port. In order for the port to receive PoE, it must be connected to a PoE compliant Ethernet switch.

Connect a PoE capable network switch to the **PoE** port.

Front Panel

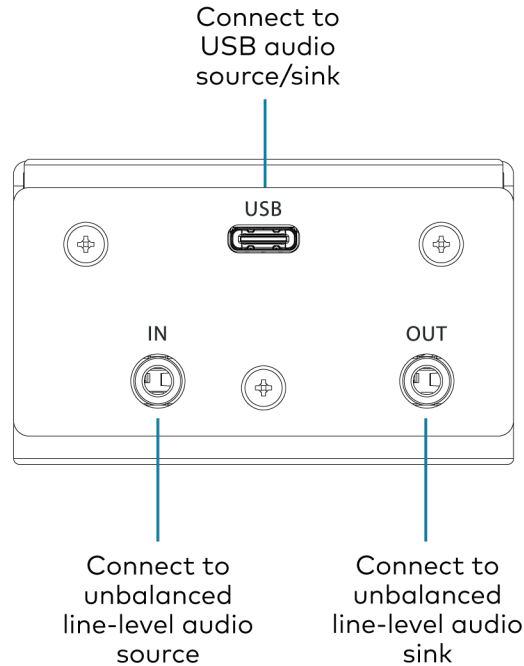

Connect a USB audio source to the **USB** port using a USB Type-C male connector .

Connect an unbalanced line-level audio source to the **INPUT** TRS port.

Connect an unbalanced line-level audio sink device to the **OUTPUT** TRS port.

Reset the Device

A network reset or factory restore may be performed when troubleshooting.

CAUTION: These procedures should only be performed as a last resort to recover an unresponsive device. Both the Network Reset and Factory Restore procedure will clear certain device settings that cannot be recovered once the procedure is complete. Before performing these procedures, please contact Crestron True Blue Support via phone, email or chat as described at www.crestron.com/support.

Network Reset

1. Ensure the device is powered on.
2. Press and hold the **SETUP** button for up to 15 seconds until the **SETUP** LED flashes red.

The device will reboot, and the default network settings will be reset. The device will be reverted to its default hostname, with DHCP enabled, and no static IP set.

Factory Restore

1. Turn off the device by disconnecting the power cable from the device.
2. Press and hold the **SETUP** button and then reconnect the power cable while still holding the **SETUP** button. Continue holding the **SETUP** button for up to 30 seconds until the **SETUP** LED flashes.

The device will reboot, and all the factory default settings will be restored, such as audio settings, multicast addressing, etc.

CAUTION: Performing a factory restore will clear all settings from the device configuration.

DM-NAX-BTIO-1G Installation

Refer to the following sections to install the DM-NAX-BTIO-1G.

- [In the Box on page 129](#)
- [Mount the Device on page 129](#)
- [Connect the Device on page 132](#)
- [Reset the Device on page 132](#)

In the Box

Qty. Description

1	DM-NAX-BTIO-1G
---	----------------

Additional Items

- | | |
|---|-----------------------------------------------------|
| 1 | Metal mounting bracket, steel (2016054) |
| 2 | Screw, 06-32, 1/4 in., Pan Head, Phillips (2007218) |
| 2 | Screws, 6-32 x 3/4 in., Truss Head, Combo (2009211) |

Mount the Device

The DM-NAX-BTIO-1G can be mounted under a table or into a 1-gang electrical box.

Mounting under a Table

To mount the device under a table:

1. Align the included right angle surface mount bracket with the front panel of the device.
2. Using a Phillips screwdriver and the two included 6-32 x 1/4 in. pan head screws, attach the mounting bracket to the device.

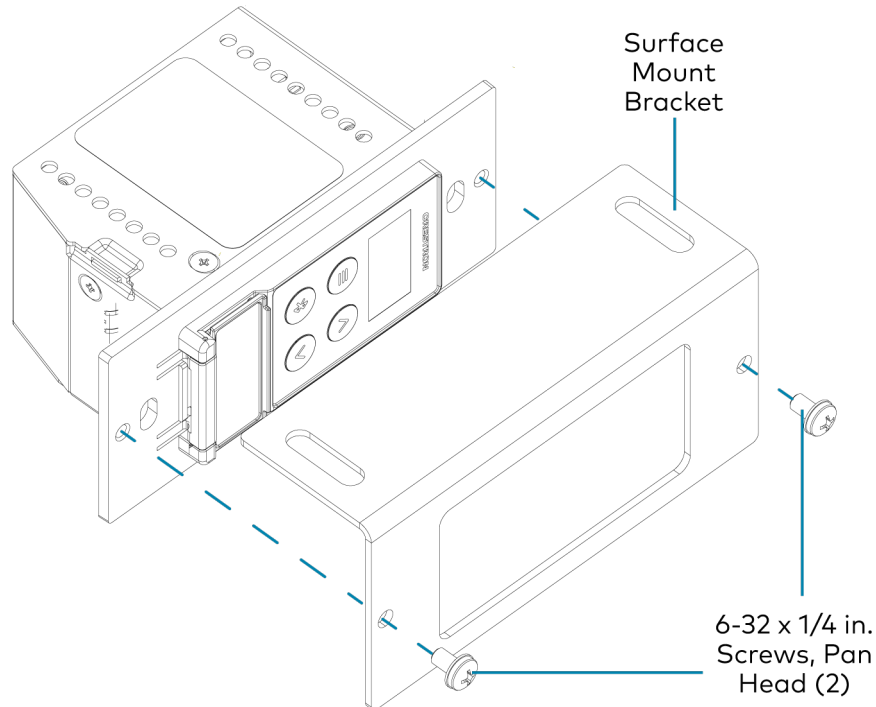

3. Secure the device to the underside of a table using the appropriate mounting screws (not included).

Mounting into a 1-Gang Electrical Box

NOTES:

- The DM-NAX-BTIO-1G should only be mounted with a RACO® 3 in. x 2 in. x 2 in. gangable metal switch box with eight 0.5 in. knockouts and plaster ears (catalog ID #420), as it was designed to fit the box dimensions and knockout placements. Alternative metal switch boxes should not be used as they may have different knockout placements, which can lead to issues running the PoE connection to the unit due to cable bend radius restrictions.
- For thermal performance reasons, fully enclosed plastic back boxes should not be used with the DM-NAX-BTIO-1G. In installations where an enclosed back box is not required, the DM-NAX-BTIO-1G can be installed into most single gang metal or plastic mud rings.
- Connector boots should not be used on CAT5e (or greater) cables being connected to the DM-NAX-BTIO-1G to avoid cable bend radius issues.

To mount the wall plate into a 1-gang electrical box:

1. Using a Phillips screwdriver and two 6-32 x 3/4 in., truss head screws, attach the wall plate to the electrical box.
2. Using a Phillips screwdriver and two 6-32 x 1/4 in., flat head screws (not included), attach a [FP-G1](#) decorator style faceplate (sold separately) to the wall plate.

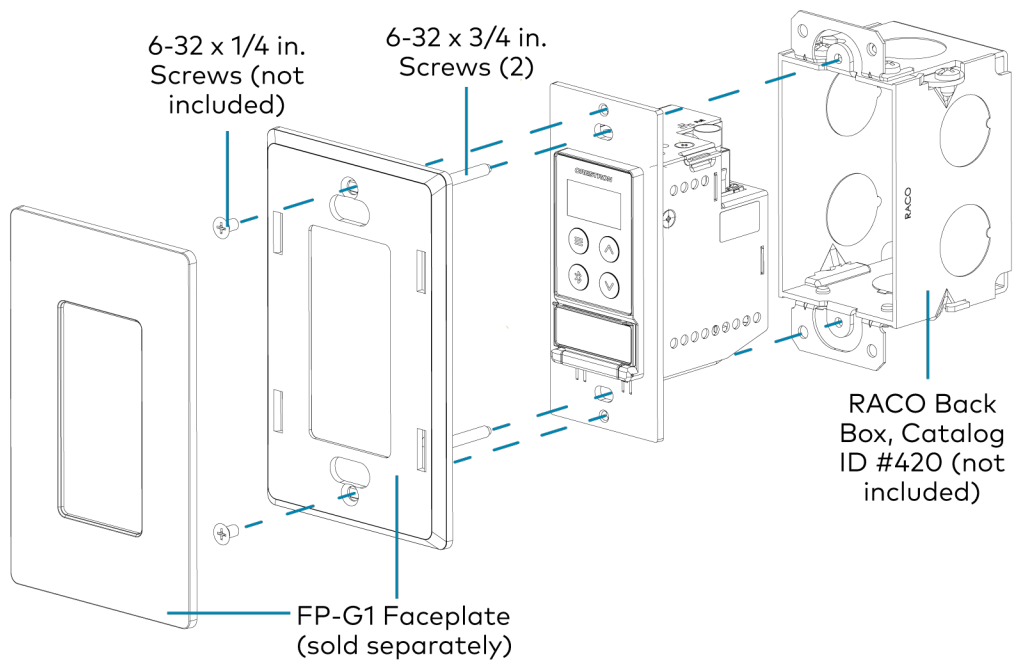

Connect the Device

Make connections to the front and top panels of the DM-NAX-BTIO-1G:

Top Panel

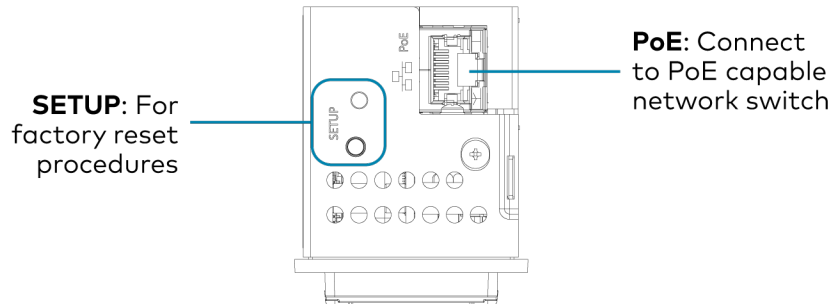

NOTE: PoE is a PoE powered device (PD) port. In order for the port to receive PoE, it must be connected to a PoE compliant Ethernet switch.

Connect a PoE capable network switch to the **PoE** port.

Front Panel

Connect an unbalanced line-level audio input to the **INPUT** TRS port.

Connect an unbalanced line-level audio output to the **OUTPUT** TRS port.

Reset the Device

A network reset or factory restore may be performed when troubleshooting.

CAUTION: These procedures should only be performed as a last resort to recover an unresponsive device. Both the Network Reset and Factory Restore procedure will clear certain device settings that cannot be recovered once the procedure is complete. Before performing these procedures, please contact Crestron True Blue Support via phone, email or chat as described at www.crestron.com/support.

Network Reset

1. Ensure the device is powered on.
2. Press and hold the **SETUP** button for up to 15 seconds until the **SETUP** LED flashes red.

The device will reboot, and the default network settings will be reset. The device will be reverted to its default hostname, with DHCP enabled, and no static IP set.

Factory Restore

1. Turn off the device by disconnecting the power cable from the device.
2. Press and hold the **SETUP** button and then reconnect the power cable while still holding the **SETUP** button. Continue holding the **SETUP** button for up to 30 seconds until the **SETUP** LED flashes.

The device will reboot, and all the factory default settings will be restored, such as audio settings, multicast addressing, etc.

CAUTION: Performing a factory restore will clear all settings from the device configuration.

Configuration

The following products can be configured:

- [DM-NAX-2XLRI-1G on page 135](#)
- [DM-NAX-8ZSA on page 189](#)
- [DM-NAX-16AIN on page 357](#)
- [DM-NAX-4ZSA-50 on page 247](#)
- [DM-NAX-4ZSP on page 304](#)
- [DM-NAX-AMP-X300 on page 385](#)
- [DM-NAX-AUD-IO on page 451](#)
- [DM-NAX-AUD-USB on page 510](#)
- [DM-NAX-BTIO-1G on page 569](#)

DM-NAX-2XLRI-1G

This section describes how to configure the DM-NAX-2XLRI-1G.

Web Interface Configuration

The DM-NAX-2XLRI-1G web interface allows you to view status information and configure network and device settings.

Access the Web Interface

To access the web interface, do either of the following:

- [Access the Web Interface with a Web Browser on page 136](#)
- [Access the Web Interface With the Crestron Toolbox™ Application on page 138](#)

The web interface is accessed from a web browser. The following table lists operating systems and their corresponding supported web browsers.

Operating System and Supported Web Browsers

OPERATING SYSTEM	SUPPORTED WEB BROWSERS
Windows® operating system	Chrome™ web browser, version 31 and later Firefox® web browser, version 31 and later Internet Explorer web browser, version 11 and later Microsoft Edge web browser
macOS® operating system	Safari® web browser, version 6 and later Chrome web browser, version 31 and later Firefox web browser, version 31 and later

Access the Web Interface with a Web Browser

1. Enter the IP address of the DM-NAX-2XLRI-1G into a web browser.

NOTE: To obtain the IP address, use the **Device Discovery Tool** option in Crestron Toolbox™ application or an IP scanner application.

2. If you are creating a user account for the first time, do the following; otherwise, skip to step 3.
 - a. Enter a username in the **Username** field.
 - b. Enter a password in the **Password** field.
 - c. Re-enter the same password in the **Confirm Password** field.

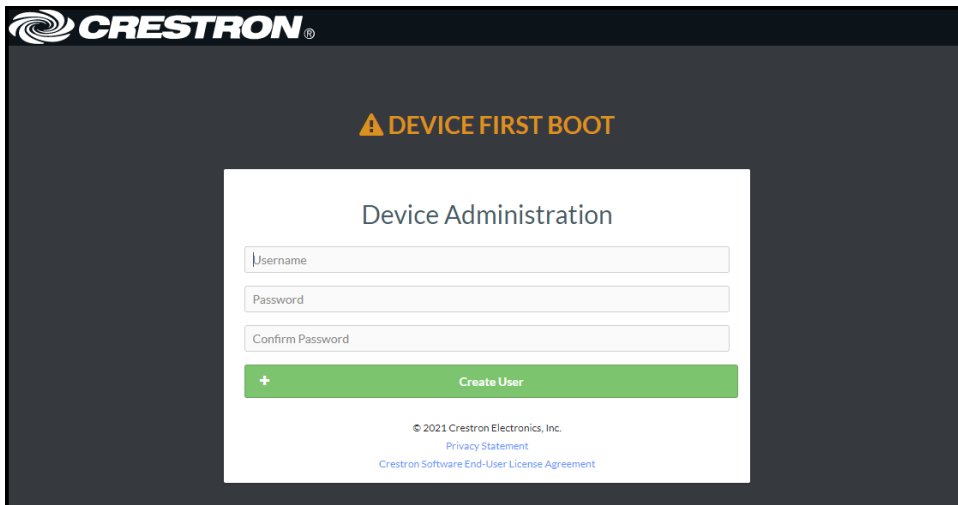

CRESTRON®

⚠ DEVICE FIRST BOOT

Device Administration

Username

Password

Confirm Password

+ Create User

© 2021 Crestron Electronics, Inc.
[Privacy Statement](#)
[Crestron Software End-User License Agreement](#)

- d. Select **Create User**. The Device Administration page appears.

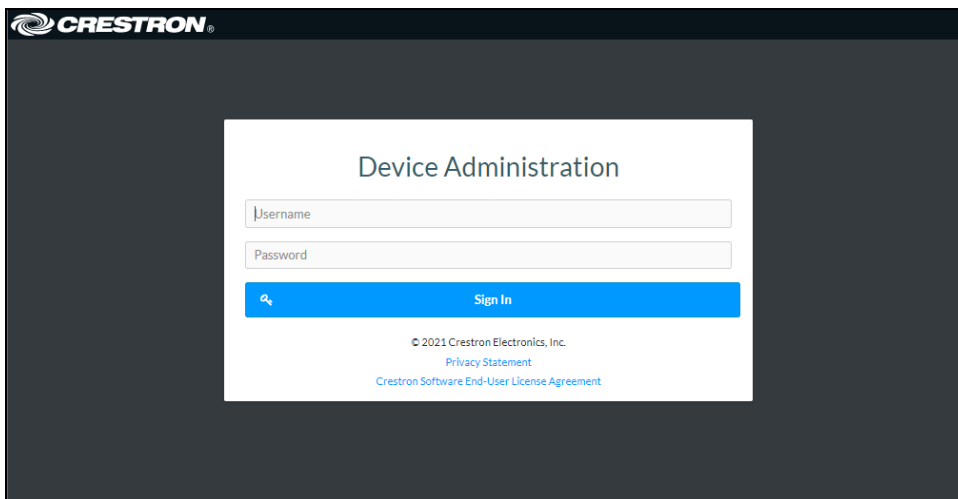

CRESTRON®

Device Administration

Username

Password

🔍 Sign In

© 2021 Crestron Electronics, Inc.
[Privacy Statement](#)
[Crestron Software End-User License Agreement](#)

3. Enter the username in the **Username** field.
4. Enter the password in the **Password** field.
5. Select **Sign In**.

Access the Web Interface With the Crestron Toolbox™ Application

To access the web interface by opening a web browser from the Crestron Toolbox™ application:

1. Open the Crestron Toolbox application.
2. From the **Tools** menu, select **Device Discovery Tool**. You can also access the Device Discovery Tool by selecting the Device Discovery Tool icon  in the Crestron Toolbox toolbar. The DM-NAX-2XLRI-1G is discovered and listed in the device list on the left side of the screen. The associated host name, IP address, and firmware version are also displayed.

NOTE: If there is security software running on the computer, a security alert might be displayed when the Crestron Toolbox application attempts to connect to the network. Make sure to allow the connection, so that the Device Discovery Tool can be used.

3. In the Device Discovery Tool list, select the device.
4. Enter the device credentials in the **Authentication Required** dialog that opens, then select **Log In**.
5. Select **Web Configuration**.

Action

The **Action** drop-down menu is displayed at the top right side of the interface and provides quick access to common device functions:

- [Save Changes on page 139](#)
- [Revert on page 139](#)
- [Reboot on page 140](#)
- [Restore to Factory Default Settings on page 140](#)
- [Update Firmware on page 140](#)
- [Download Logs on page 141](#)
- [Manage Certificates on page 141](#)

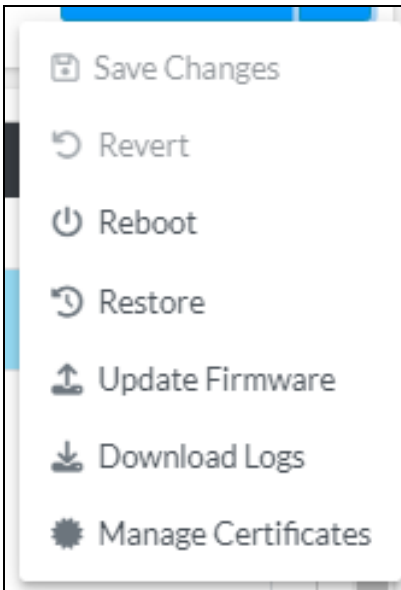

Save Changes

Select **Save Changes** to save any changes made to the configuration settings.

Revert

Select **Revert** to revert the device back to the last saved configuration settings.

Reboot

Certain changes to the settings may require the DM-NAX-2XLRI-1G to be rebooted to take effect. To reboot the device:

1. Select **Reboot** in the **Action** drop-down menu. The **Confirmation** message box appears.

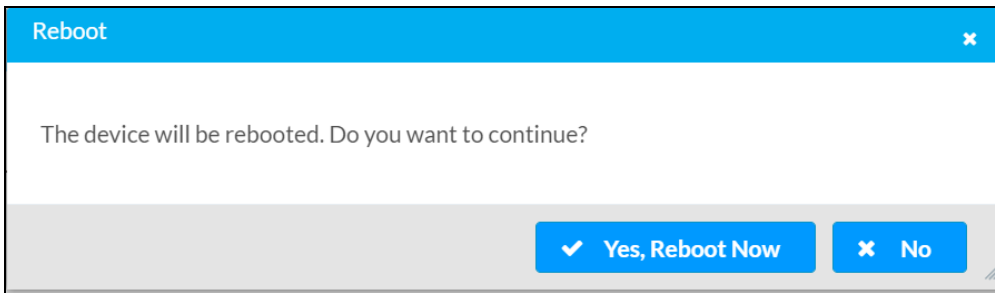

2. Select **Yes, Reboot Now** to reboot the device. The **Reboot** message box appears. Wait for the device reboot to complete before attempting to reconnect to the device.

Restore to Factory Default Settings

1. Select **Restore** in the **Action** drop-down menu to restore the settings of the DM-NAX-2XLRI-1G to factory defaults.

NOTE: When settings are restored, all settings, including the network settings, will revert to the factory default. If a static IP address is set, restoring the device to factory default settings will revert the IP address to the default DHCP mode.

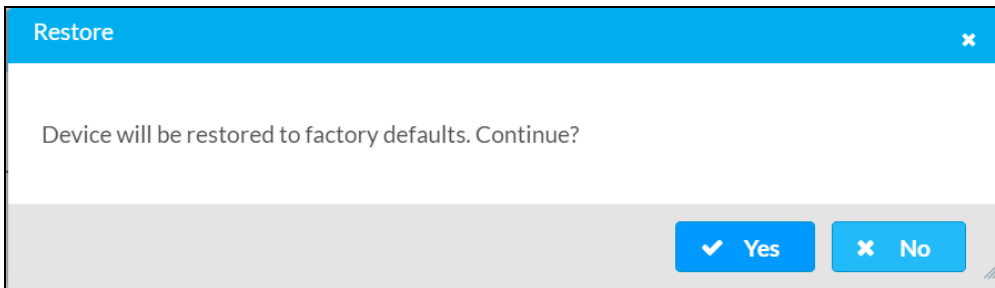

2. Select **Yes** in the **Confirmation** dialog to restore the DM-NAX-2XLRI-1G to factory settings. Select **No** to cancel the restore operation.

A dialog is displayed again, indicating that the restore process was successful and that the device rebooted.

You can also restore to factory settings by pressing and holding the **SETUP** button on the rear panel of the device with power disconnected then connect the power supply and continue to hold **SETUP** button for 30 seconds.

Update Firmware

1. Select **Update Firmware** in the **Action** drop-down menu.
2. In the **Firmware Upgrade** dialog, select **+ Browse**.

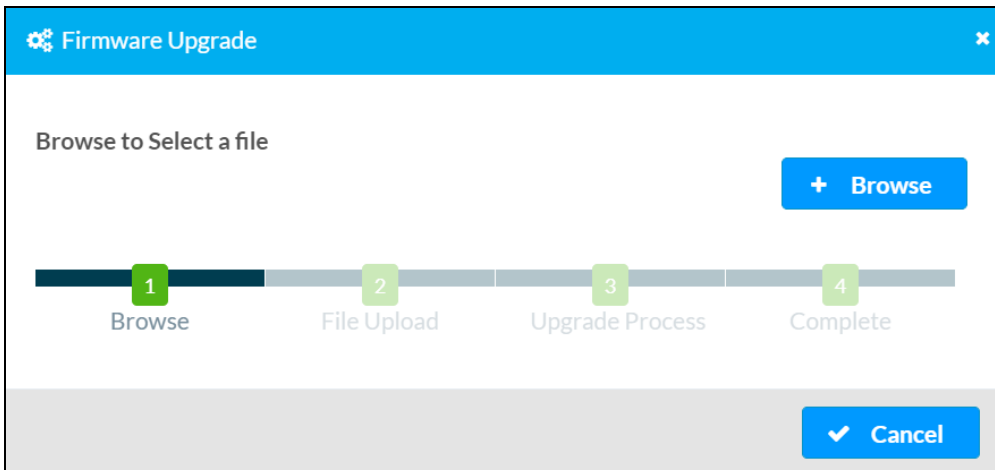

3. Locate and select the desired firmware file, then select **Open**. The selected firmware file name is displayed in the **Firmware Upgrade** dialog.
4. Select **Load** and wait for the progress bar to complete and for **OK** to become selectable.
5. Select **OK**. The device with new firmware can now be accessed.

Download Logs

Select **Download Logs** in the **Action** drop-down menu to download the device message logs for diagnostic purposes.

The log file is downloaded to the Downloads folder of the PC.

Manage Certificates

Use the **Manage Certificates** dialog to add, remove, and manage certificates used in 802.1x and other protected networks.

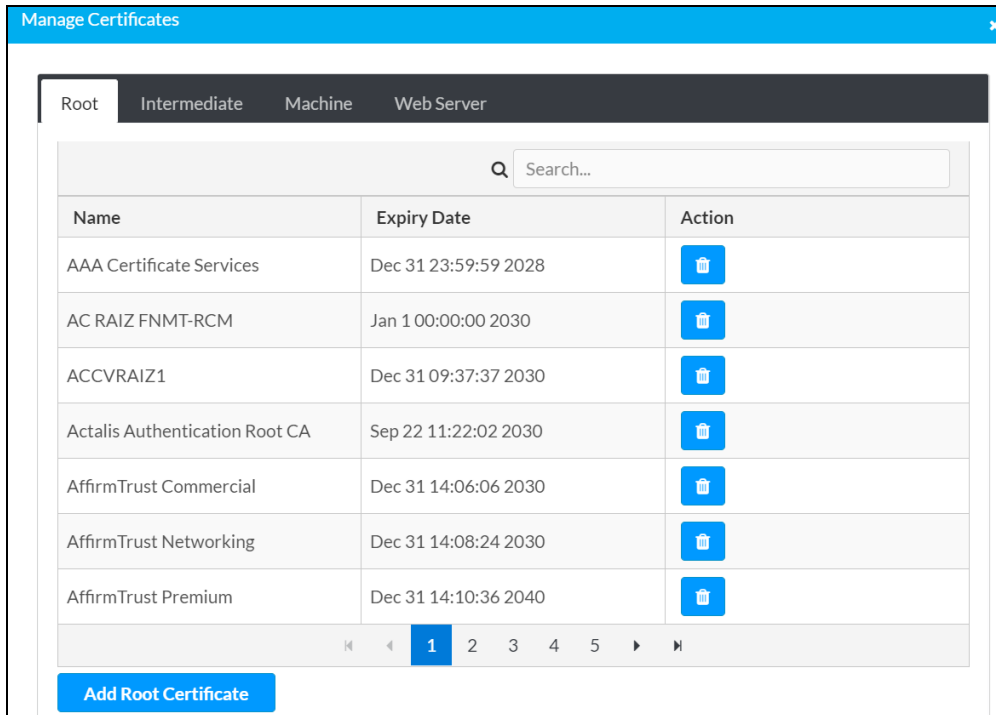

Select **Manage Certificates** in the **Action** drop-down menu. The following certificate tabs are displayed:

- **Root:** The Root certificate is used by the DM-NAX-2XLRI-1G to validate the network's authentication server. The DM-NAX-2XLRI-1G has a variety of Root certificates, self-signed by trusted CAs (Certificate Authorities) preloaded into the device. Root certificates must be self-signed.
- **Intermediate:** The Intermediate store holds non self-signed certificates that are used to validate the authentication server. These certificates will be provided by the network administrator if the network does not use self-signed Root certificates.
- **Machine:** The machine certificate is an encrypted PFX file that is used by the authentication server to validate the identity of the DM-NAX-2XLRI-1G. The machine certificate will be provided by the network administrator, along with the certificate password. For 802.1x, only one machine certificate can reside on the device.
- **Web Server:** The Web Server certificate is a digital file that contains information about the identity of the web server.

To Add Certificates

1. Select the corresponding certificate tab.
2. Select **Add Root Certificate**.
3. Select **+ Browse**.
4. Locate and select the file, then select **Open**.

NOTE: If the certificate is a Machine Certificate, enter the password provided by the network administrator.

5. Select **OK**. This will add the certificate to the list box, displaying the file name and expiration date. The certificate is now available for selection and can be loaded to the device.

To Delete Certificates

1. Select the corresponding certificate tab.
2. Select the trashcan icon  in the **Actions** column to delete the certificate.
3. Select **Yes** when prompted to delete the certificate or **No** to cancel the deletion.

Status

The **Status** page is the first page displayed when opening the interface of the DM-NAX-2XLRI-1G. It displays general information about the DM-NAX-2XLRI-1G (such as Model Name, Firmware Version, and Serial Number), current network settings (such as Host Name and IP Address, etc.), and input and output ports' current status.

The **Status** page can be accessed at any time by selecting the **Status** tab of the DM-NAX-2XLRI-1G interface.

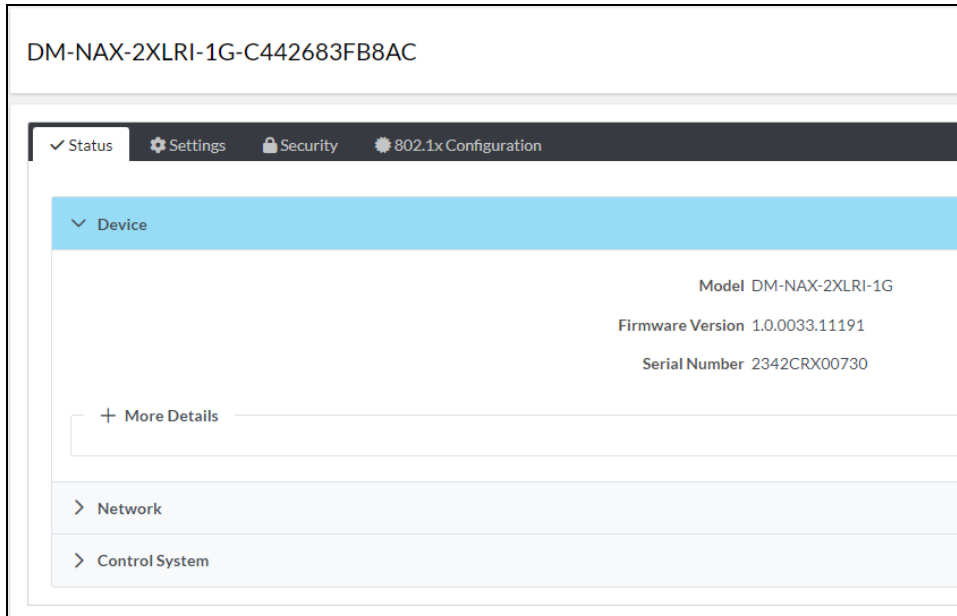

Information displayed on the **Status** tab is organized into different sections.

Device

The **Device** section displays the **Model**, **Firmware Version**, and **Serial Number** of the DM-NAX-2XLRI-1G.

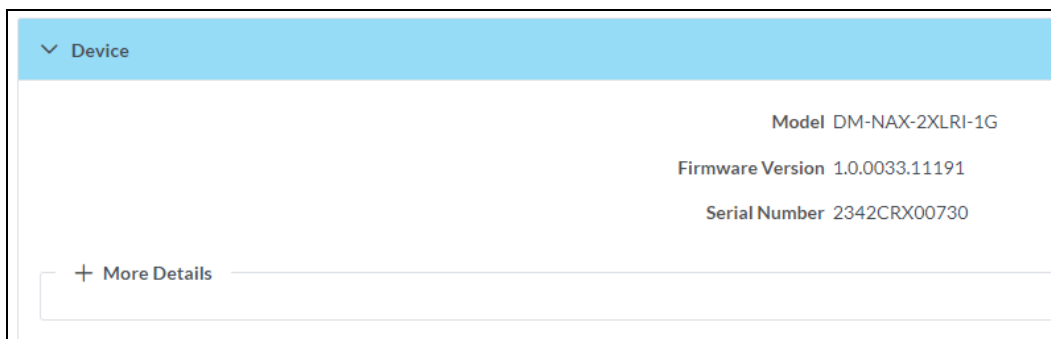

Select **+ More Details** to review additional information about the DM-NAX-2XLRI-1G.

More Details

DM-NAX-2XLRI-1G	1.0.0033.11191
Build	Feb 13 2024 (531246)
Updater	1.0.0033.11191
Bootloader	1.00.00
CCUI Version	1.1327.1
XIOSDK	3.8.2
IoTSDK	1.11.0
Build time	11:19:07
Product ID	0x7A07
Revision ID	0x0200
HDCP2X-SKE	HDCP2X-SKE [v9.0000.00000,#FFFFFFFFF]
PRE-BOOT	[v9.0000.00000]
BOOTLOADER	[v9.0000.00000]
ctrl-extclk-in-pps	Driver v1.1
ctrl-prod-info	Driver v3.0
PUF	1.0.0033.11191
Forced Auth Mode	True

Network

The **Network** section displays network-related information about the DM-NAX-2XLRI-1G, including the Hostname, Domain Name, and DNS Servers.

Network

Hostname	DM-NAX-2XLRI-1G-C442683FB8AC
Domain Name	lan
DNS Servers	192.168.1.1(DHCP)

Adapter 1

DHCP	On
IP Address	192.168.1.231
Subnet Mask	255.255.255.0
Default Gateway	192.168.1.1
Link Active	true
MAC Address	c4.42.68.3f.b8.ac

NOTE: By default, the host name of the DM-NAX-2XLRI-1G consists of the model name followed by the MAC address of the device. For example, DM-NAX-2XLRI-1G-00107FB58088.

Select **+ Adapter 1** to display an expanded section that shows additional information. If **+ Adapter 1** is selected, select **- Adapter 1** to collapse the section.

Control System

The **Control System** section displays connection information, consisting of the following:

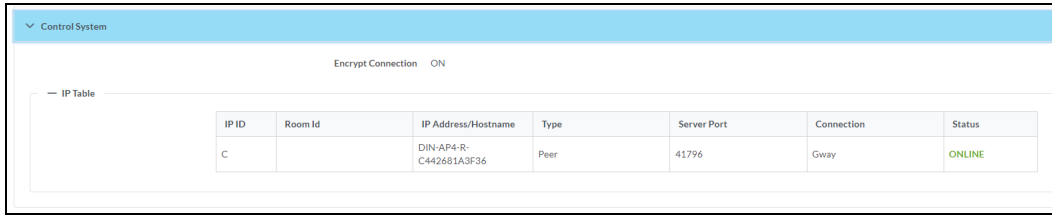

The screenshot shows a web interface for the Control System. At the top, there is a blue header with a dropdown arrow and the text "Control System". Below the header, there is a toggle switch for "Encrypt Connection" which is currently set to "ON". Underneath, there is a section titled "IP Table" which contains a table with the following data:

IP ID	Room Id	IP Address/Hostname	Type	Server Port	Connection	Status
C		DIN-AP4-R- C442681A3F36	Peer	41796	Gway	ONLINE

- **Encrypt Connection:** ON or OFF
- **IP ID:** Reports the currently used IP ID of the DM-NAX-2XLRI-1G
- **IP Address/Hostname:** The IP address of the control system
- **Room ID:** Displays the room ID
- **Status:** OFFLINE or ONLINE

Settings

The **Settings** page enables configuration of the DM-NAX-2XLRI-1G settings. The **Settings** page can be accessed at any time by selecting the **Settings** tab of the DM-NAX-2XLRI-1G interface.

Many options in the **Settings** page are exclusive to a specific device mode: Residential or Commercial. The DM-NAX-2XLRI-1G is in Commercial mode by default.

This section provides the following information:

- [Commercial Mode on page 147](#)
- [Residential Mode on page 164](#)

Commercial Mode

This section provides the following information:

- [System Setup on page 147](#)
- [Commissioning on page 152](#)
- [Output Channels on page 153](#)
- [Input Channels on page 156](#)
- [DM NAX Streams on page 159](#)
- [Mixing on page 162](#)

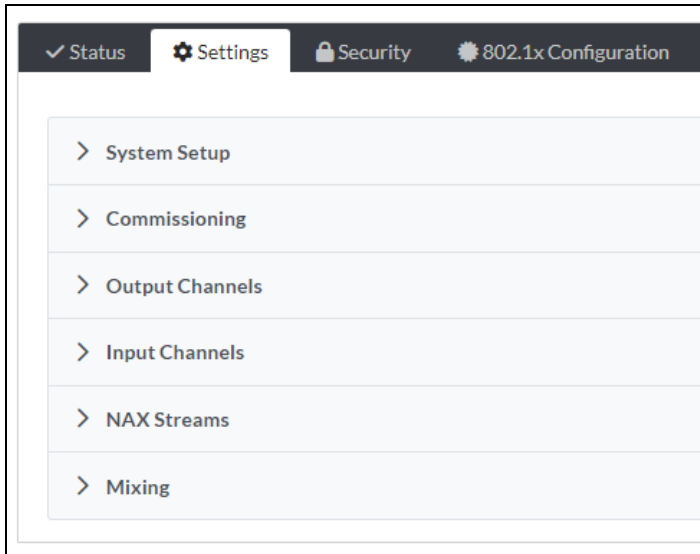

System Setup

The **System Setup** section contains settings for **Date/Time**, **Auto Update**, **Network**, and **Control System**.

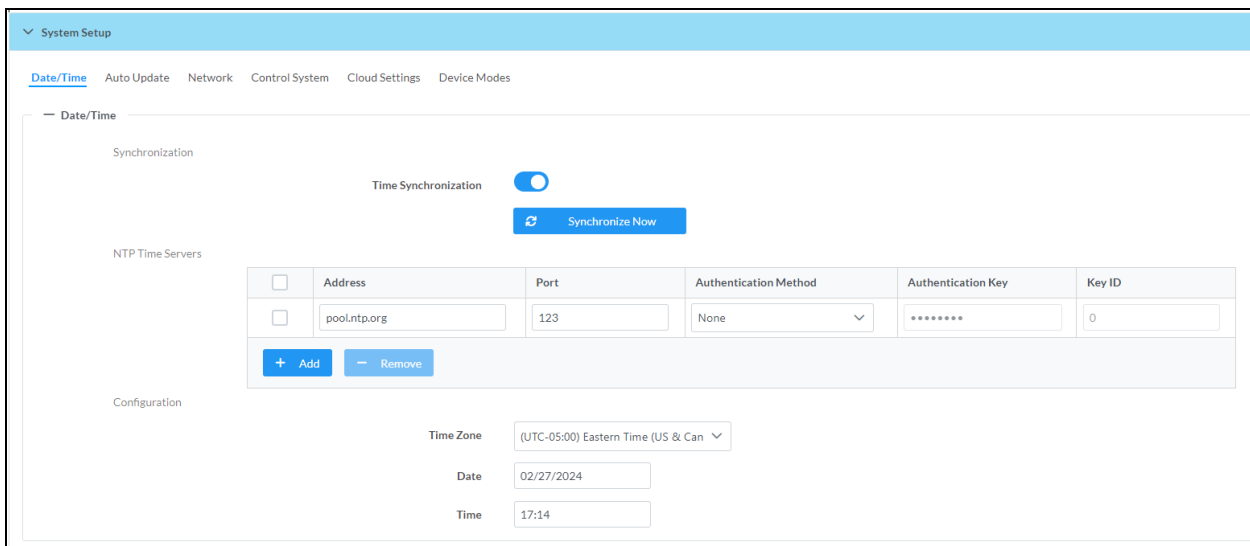

Date/Time

Use the **Date/Time** tab to configure the date and time settings of the DM-NAX-2XLRI-1G.

— Date/Time

Synchronization

Time Synchronization

 Synchronize Now

NTP Time Servers

<input type="checkbox"/>	Address	Port	Authentication Method	Authentication Key	Key ID
<input type="checkbox"/>	pool.ntp.org	123	None	*****	0

+ Add - Remove

Configuration

Time Zone: (UTC-05:00) Eastern Time (US & Can) ▾

Date: 02/21/2024

Time: 12:40

Time Synchronization

1. Set the **Time Synchronization** toggle to the right position to enable or left position to disable time synchronization. By default, time synchronization is enabled.
2. In the **NTP Time Servers** table, enter the URL of a NTP (Network Time Protocol) or SNTP (Simple Network Time Protocol) server. Up to three time servers can be added on a device.
3. Select **Synchronize Now** to perform time synchronization between the device's internal clock and the time server.

Time Configuration

1. Open the **Time Zone** drop-down menu to select the applicable time zone.
2. In the **Date** field, enter the current date.
3. In the **Time (24hr Format)** field, enter the current time in 24-hour format.

Select **Save Changes** to save the settings.

Select **Revert** from the **Action** drop-down menu to revert to the previous settings without saving.

Auto Update

The DM-NAX-2XLRI-1G can automatically check for and install firmware updates at scheduled intervals via the Auto Update feature.

The screenshot shows the 'Auto Update' configuration interface. It includes the following elements:

- Auto Update:** A toggle switch that is currently turned on (to the right).
- Custom URL:** A toggle switch that is currently turned off (to the left).
- Custom URL Path:** A text input field containing the URL `https://crestrondevicefiles.blob.core.win`.
- Schedule:**
 - Day of Week:** A dropdown menu currently set to 'Daily'.
 - Time of Day:** A text input field containing '02:07'.
 - Poll Interval:** A text input field containing '0', followed by the label 'Minutes'.
- Update Now:** A blue button located at the bottom right of the configuration area.

1. Set the **Auto Update** toggle to the right position to enable Auto Update.
2. Define the URL to download the updates by doing either of the following:
 - a. Use the default URL to download the updates from the Crestron server.
 - b. Use a custom URL. Set the **Custom URL** toggle to the right position to enable a custom URL. In the **Custom URL Path** text box, enter the path to a custom manifest file in the FTP or SFTP URL format. Use the Crestron Auto Update Tool to generate a custom manifest file, then store the file on an FTP (File Transfer Protocol) or SFTP (Secure File Transfer Protocol) server.
3. Set a schedule for the automatic firmware update by doing either of the following:
 - a. Select the desired **Day of Week** and **Time of Day** (24-hour format) values.
 - b. Set the **Poll Interval** by entering a value from **60** to **65535** minutes. A value of **0** disables the Poll Interval.
4. Select **Save Changes**.

Selecting **Update Now** causes the device to check for a firmware update immediately. If a schedule was set in step 4 above, that schedule still remains in effect.

Network

The **Network** tab contains network-related settings for the DM-NAX-2XLRI-1G, including the Hostname, Domain, Primary Static DNS, and Secondary Static DNS.

The screenshot shows the Network configuration interface for Adapter 1. The settings are as follows:

Field	Value
Hostname *	DM-NAX-2XLRI-1G-C442683FB8AC
Domain	lan
Primary Static DNS	192.168.1.1(DHCP)
Secondary Static DNS
DHCP Enabled	<input checked="" type="checkbox"/>
IP Address	192.168.1.231
Subnet Mask	255.255.255.0
Default Gateway	192.168.1.1

NOTE: By default, the hostname of the DM-NAX-2XLRI-1G consists of the model name followed by the MAC address of the device. For example, DM-NAX-2XLRI-1G-00107FB58088.

Adapter 1

The Adapter 1 subheading contains settings for DHCP, IP Address, Subnet Mask, and Default Gateway of Ethernet adapter 1 on the rear panel of the device.

NOTE: DM NAX devices' internal processes use IP addresses in the 10.10.10.xxx range. This IP range should be avoided when addressing DM NAX devices to prevent conflicts.

Set the **DHCP** toggle to enabled (right) or disabled (left) to specify whether the IP address of the DM-NAX-2XLRI-1G is to be assigned by a DHCP (Dynamic Host Configuration Protocol) server.

- **Enabled:** When DHCP is enabled (default setting), the IP address of the DM-NAX-2XLRI-1G is automatically assigned by a DHCP server on the local area network (LAN).
- **Disabled:** When DHCP is disabled, manually enter information in the following fields:
 - **Primary Static DNS:** Enter a primary DNS IP address.
 - **Secondary Static DNS:** Enter a secondary DNS IP address.
 - **IP Address:** Enter a unique IP address for the DM-NAX-2XLRI-1G.
 - **Subnet Mask:** Enter the subnet mask that is set on the network.
 - **Default Gateway:** Enter the IP address that is to be used as the network's gateway.

To save any new network entries, select **Save Changes**.

Control System

IP ID	IP Address/Hostname	Room Id
C	DIN-AP4-R-C442681A3F36	Room Id

1. Select **Encrypt Connection** to navigate to the **Security** tab to configure encryption settings.
 - a. Enter the username in the **Control System Username** field.
 - b. Enter the password in the **Control System Password** field.
2. Select **+ Add** to add an IP table entry to the **IP Table**.
 - a. Enter the Room ID in the **Room ID** field.
 - b. Enter the IP ID of the DM-NAX-2XLRI-1G in the **IP ID** field.
 - c. Enter the IP address or hostname of the control system in the **IP Address/Hostname** field.
3. Select **Save Changes** to save the new entries. The Control System Save message box appears, indicating that the control system settings were saved successfully. Select **Revert** to revert to the previous settings without saving.

Cloud Settings

Cloud Configuration Service Connection

Set the **Cloud Settings** toggle to enabled (right) or disabled (left) to specify whether the DM-NAX-2XLRI-1G can communicate with the XiO Cloud® platform.

Device Modes

Use the **Device Modes** tab to configure the **Application Mode** of the DM-NAX-2XLRI-1G.

Application Mode: Commercial (Advanced)

Application Mode determines which options and controls are available.

- Select **Residential (Standard)** or **Commercial (Advanced)**. A **Reboot** confirmation message box appears.

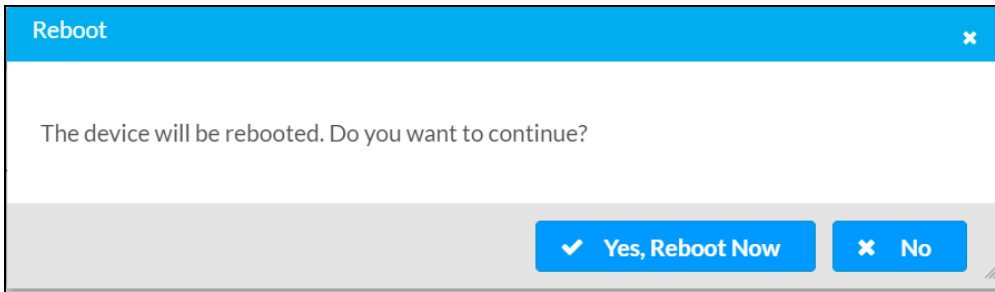

- Select **Yes, Reboot Now** to reboot the device into the selected mode. The **Reboot** message box appears.
- Wait for the device reboot to complete before attempting to reconnect to the device.

By default, the DM-NAX-2XLRI-1G is set to **Commercial (Advanced)** mode.

Commissioning

The **Commissioning** section provides a quick way to automatically assign multicast addresses to the device's internal audio-over-IP stream transmitters.

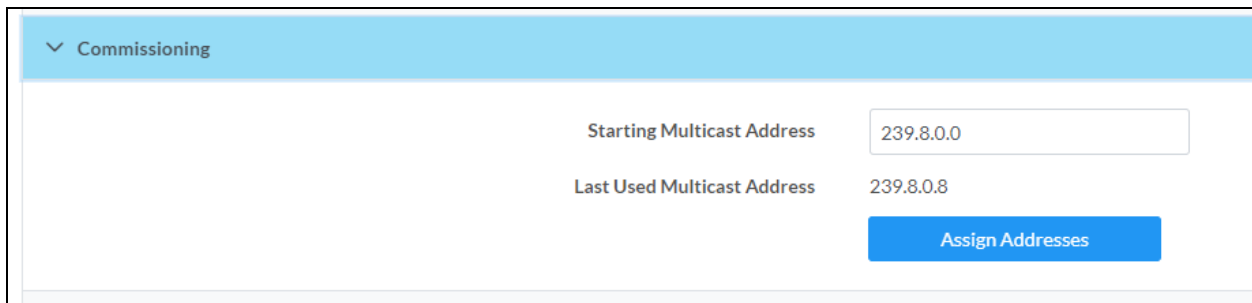

Select **Assign Addresses** to give each DM NAX transmitter in the DM-NAX-2XLRI-1G a unique multicast address beginning with the specified **Starting Multicast Address**. The valid range for **Starting Multicast Address** is 239.8.0.0 to 239.255.255.254.

NOTE: This will begin transmitting multicast traffic on your network. Refer to [Audio-over-IP Network Design on page 632](#) for details on proper audio-over-IP network management.

Output Channels

The **Zones** section contains the **Volume** and **Mute** settings for all zone outputs of the device, as well as an **Edit** option for more advanced settings within each zone.

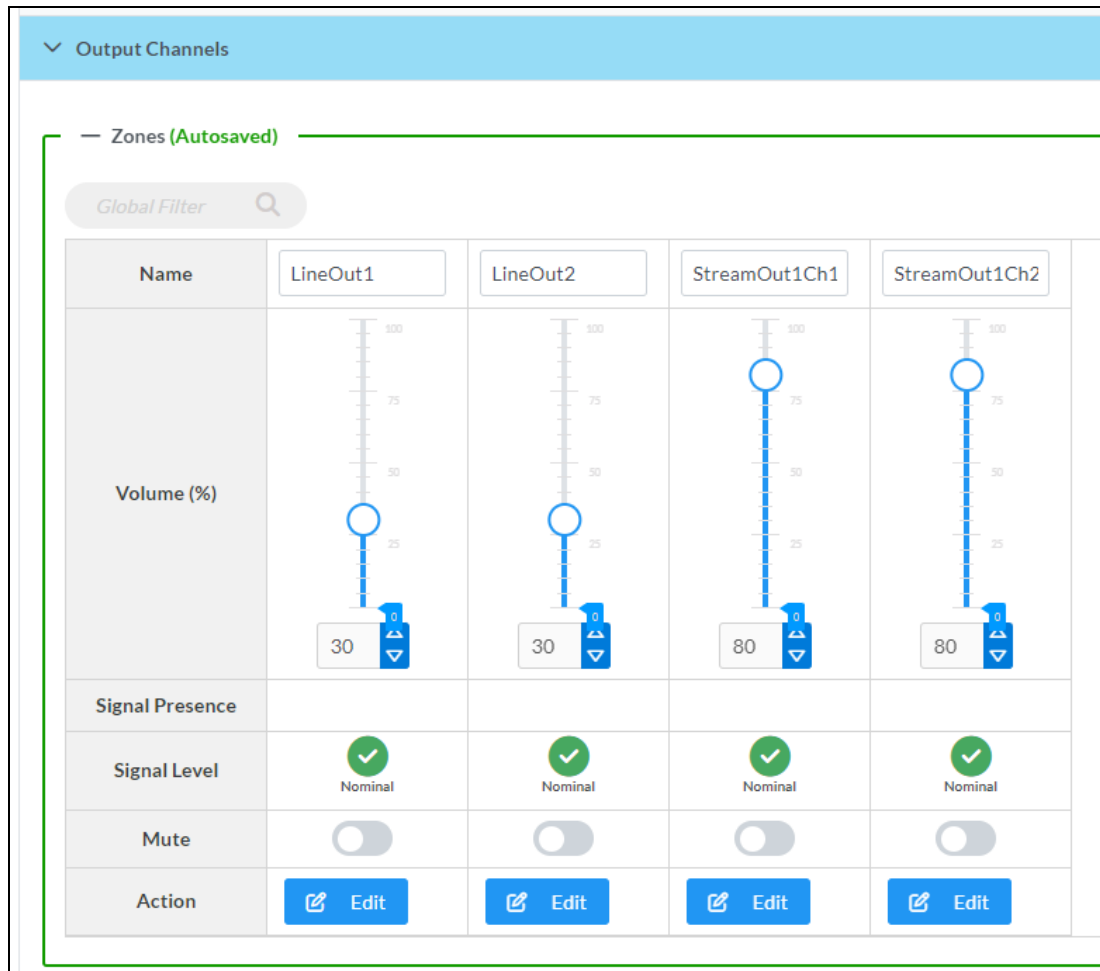

The screenshot shows the 'Output Channels' interface. At the top, there is a 'Global Filter' search bar. Below it, a section titled 'Zones (Autosaved)' contains a table with four columns representing different output channels: LineOut1, LineOut2, StreamOut1Ch1, and StreamOut1Ch2. Each column has a volume slider and a numerical input field. The 'Signal Presence' row shows empty cells. The 'Signal Level' row shows green checkmarks and the word 'Nominal'. The 'Mute' row shows greyed-out toggle switches. The 'Action' row shows blue 'Edit' buttons with a pencil icon.

Name	LineOut1	LineOut2	StreamOut1Ch1	StreamOut1Ch2
Volume (%)	 30	 30	 80	 80
Signal Presence				
Signal Level	 Nominal	 Nominal	 Nominal	 Nominal
Mute				
Action				

Signal Presence indicates whether or not an audio signal is detected in that zone.

Signal Level indicates if the signal is **Clipping** or **Nominal** (non-clipping).

- **Nominal:** The signal level is within normal operating bounds and below the clipping threshold.
- **Clipping:** The signal level is clipping or above the -3 dB warning threshold and in danger of clipping.

Give each zone a friendly name using the **Name** column of the **Zones** table. If the device is paired with a control system, these names may be overwritten by the control system's program.

To configure the zone volume, do one of the following:

- Move the **Volume** slider up to increase or down to decrease the zone volume.
- Use the **%** arrows to increase or decrease the zone volume. Values range from 0 to 100%, adjustable in increments of 1%.
- Manually enter a value in the **Volume** field.

To mute all audio output from a zone, select its respective **Mute**. To unmute the zone, select **Muted**.

Select **Edit** to view additional **Zone** and **Output** options.

Zone Settings

To configure the settings for an output channel, select **Edit**. The **Edit Zone** window appears.



Zone

Select **Zone** to access the settings for **Delay**.

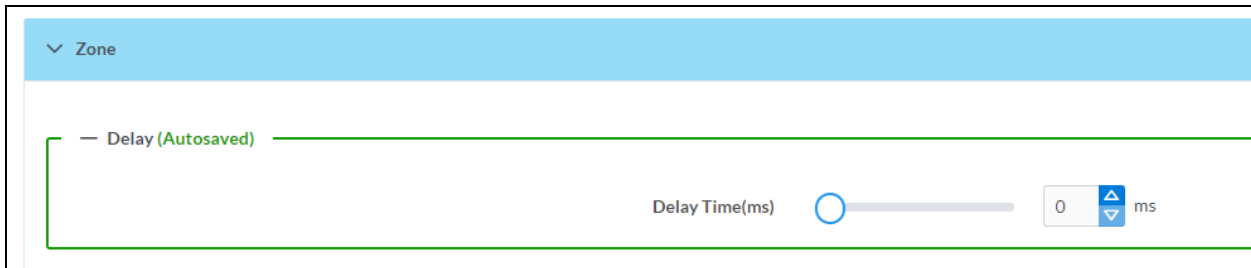

Delay

To set the delay, do one of the following:

- Move the **Delay Time(ms)** slider to the right to increase or to the left to decrease the delay time.
- Use the **ms** arrows to increase or decrease the delay. Values range from 0 ms to 85 ms, adjustable in increments of 1 ms.
- Manually enter a value in the **Delay Time(ms)** field.

NOTE: The Delay feature is only available on the line level output channels.

Output

Select **Output** to access the settings for **Minimum/Maximum Volume** and **Signal**.

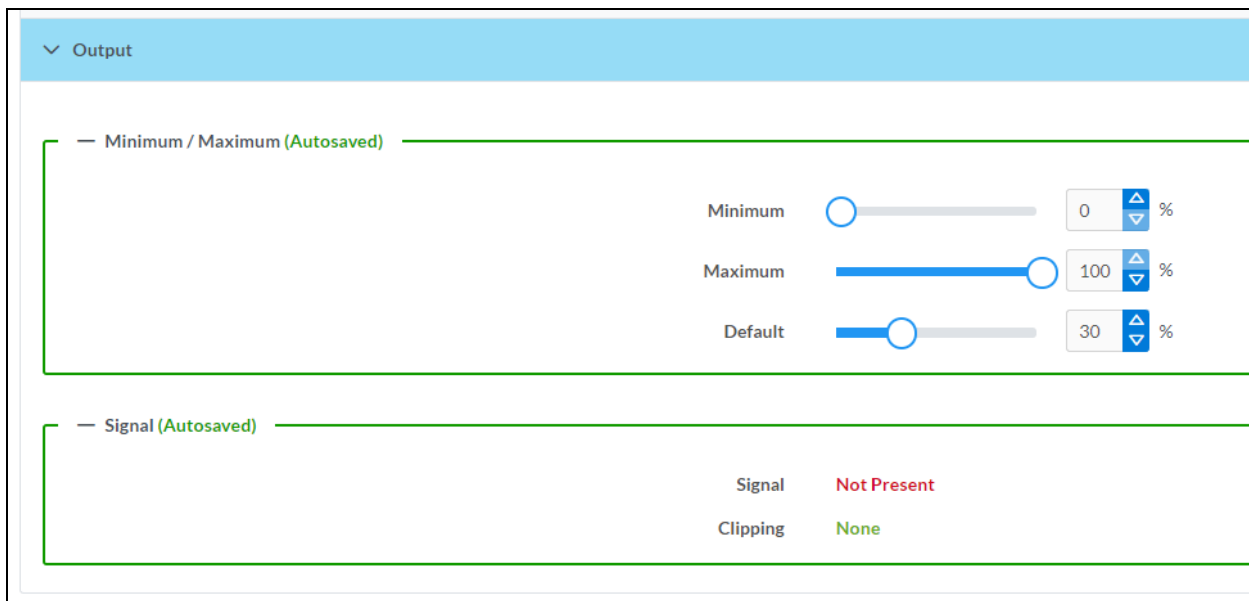

Minimum/Maximum Volume



1. To set the minimum volume of the zone, do one of the following:
 - Move the **Minimum** slider to the right to increase or to the left to decrease the minimum volume.
 - Use the **%** arrows to increase or decrease the minimum volume. Values range from 0 to 50%, adjustable in increments of 1%.
 - Manually enter a value in the **Minimum** field.
2. To set the maximum volume of the zone, do one of the following:
 - Move the **Maximum** slider to the right to increase or to the left to decrease the maximum volume.
 - Use the **%** arrows to increase or decrease the maximum volume. Values range from 70 to 100%, adjustable in increments of 1%.
 - Manually enter a value in the **Maximum** field.

NOTE: When a **Minimum** and **Maximum** volume are set, the 1-100% range represented by the **Zone** and **Default** volume controls are scaled to the range set. For example, if a **Minimum** of 10% and a **Maximum** of 80% are set for a zone, the 1-100% range of the **Zone** volume control is scaled to the 10%-80% range set as the **Minimum** and **Maximum**.

3. To set the default volume of the zone, do one of the following:
- Move the **Default** slider to the right to increase or to the left to decrease the default volume.
 - Use the **%** arrows to increase or decrease the default volume. Values range from 0 to 50%, adjustable in increments of 1%.
 - Manually enter a value in the **Default** field.

NOTE: The **Default** volume is applied as the **Zone** volume any time the zone receives a source route and no source was previously routed to that zone.

Signal

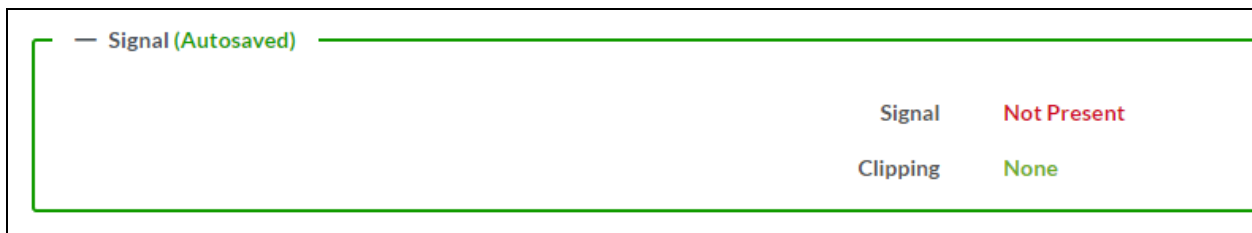

The **Signal** section is a read-only field that displays the **Signal** and **Clipping** status of the zone output.

- If an output signal is present but not clipping, **Signal** will display **Present** in green and **Clipping** will display **None** in green.
- If an output signal is present and clipping, **Signal** will display **Present** in green and **Clipping** will display **Present** in red.
- If no output signal is detected, **Signal** will display **Not Present** in red and **Clipping** will display **None** in green.

Input Channels

The **Input Channels** section is used to configure the **Name**, **Compensation**, and **Mute** attributes of the front panel XLR inputs on the DM-NAX-2XLRI-1G.

Input Channels

— Analog Inputs (Autosaved)

Name	XLR1	XLR2	StreamIn1Ch1	StreamIn1Ch2
Analog Gain (db)	17	17		
Compensation (db)				
Signal Present				
Signal Level				
Mode	Line	Line		
Phantom Power	<input type="checkbox"/>	<input type="checkbox"/>		
Mute	<input type="checkbox"/>	<input type="checkbox"/>	<input type="checkbox"/>	<input type="checkbox"/>
Action				

Configure Inputs

1. If needed, enter a friendly name for each input in its **Name** field.
2. To set an analog gain value for a given input, use the **db** arrows to increase or decrease the compensation. Values range from 0 dB to 60 dB, adjustable in increments of 1 dB.
3. To set a level compensation adjustment for a given input, do one of the following:
 - Move the **Compensation** slider up to increase or down to decrease the level compensation. Compensation increases or decreases the level of the incoming audio signal on any of the physical inputs on the device's rear panel.
 - Use the **db** arrows to increase or decrease the compensation. Values range from -10 dB to 10 dB, adjustable in increments of 1 dB.
 - Manually enter a value in the **Compensation** field.
4. To switch between microphone level and line level input signals, expand the **Mode** drop-down and select the desired input signal level. By default, the XLR inputs are both set to **Line** level.
5. Set a channel's **Phantom Power** toggle to the right to enable +48V phantom power. Set the channel's **Phantom Power** toggle to the left to disable phantom power. By default, **Phantom Power** is disabled, and can only be enabled while the **Mode** of the channel is set to **Mic**.

- To mute the signal from the corresponding input, set the **Mute** toggle to the right. To disable the mute, set the **Mute** toggle to the left. By default, **Mute** is disabled.

Monitor the device's input signals using the text indicators in the **Signal Present** and **Clipping Detected** columns:

- **Signal Presence** indicates whether or not a signal is detected in that zone.
- **Clipping Detected** indicates if the signal is **Clipping** or **Nominal** (non-clipping).

Select **Edit** to open the equalizer for a given input channel.

Equalizer Settings

The screenshot shows the 'Equalizer Settings (Autosaved)' interface for the XLR1 input. It features a table with five columns representing different frequency bands (Band01 to Band05). Each band has a vertical gain slider, a dropdown menu for the filter type (set to 'EQ'), and numerical input fields for frequency and bandwidth. Additionally, there are bypass toggle switches and 'Reset' buttons for each band.

Band	Band01	Band02	Band03	Band04	Band05
Gain	0	0	0	0	0
Type	EQ	EQ	EQ	EQ	EQ
Frequency	32	64	125	250	500
Bandwidth	0.33	0.33	0.33	0.33	0.33
Bypass	<input type="checkbox"/>	<input type="checkbox"/>	<input type="checkbox"/>	<input type="checkbox"/>	<input type="checkbox"/>
Actions	Reset	Reset	Reset	Reset	Reset

Each XLR input channel of the DM-NAX-2XLRI-1G has a dedicated five-band equalizer that can be fully customized to tune the input signal to the needs of an install. Each band can have a discrete gain, filter type, center frequency, and bandwidth set, and can also be bypassed.

To configure a given equalizer band:

- To set a band's gain, do one of the following:
 - Move the **Gain** slider up to increase or down to decrease the gain.
 - Use the arrows to increase or decrease the gain. Values range from -40 dB to 20 dB, adjustable in increments of 0.1 dB.
 - Manually enter a value in the **Gain** field.

2. Select a filter type from the **Type** drop-down menu. By default, all bands are set to the **EQ** filter type. Some filter types will disable other settings in their respective band while enabled. For example, selecting the **LowPass** filter type for a band will disable that band's **Gain** and **Bandwidth** settings, since the **LowPass** filter applies a fixed roll-off slope at a set frequency. The available filter types are:
 - **EQ:** a fully parametric filter that can boost or cut a range of frequencies.
 - **Notch:** a parametric filter designed to more precisely cut a frequency or range of frequencies. A notch filter can achieve a narrower bandwidth than the standard **EQ** parametric filter type.
 - **TrebleShelf:** a filter that boosts or cuts all frequencies above a set frequency by a set gain.
 - **BassShelf:** a filter that boosts or cuts all frequencies below a set frequency by a set gain.
 - **LowPass:** a filter that fully cuts all frequencies above a set frequency using a fixed roll-off slope of -12 dB per octave.
 - **HighPass:** a filter that fully cuts all frequencies below a set frequency using a fixed roll-off slope of -12 dB per octave.
3. Set a center frequency for the equalizer band to tune a specific portion of the audible frequency spectrum. To set the center frequency, do one of the following:
 - Use the arrows to increase or decrease the frequency. Values range from 20 Hz to 20 kHz, adjustable in increments of 1 Hz. Each band has a default center frequency that will be applied if **Reset** at the bottom of the band is selected.
 - Manually enter a value in the **Frequency** field.
4. Set a bandwidth to determine how wide of a frequency range is effected by the equalizer band. To set the bandwidth, do one of the following:
 - Use the arrows to increase or decrease the bandwidth. Values range from 0.1 octaves to 4.0 octaves, adjustable in increments of 0.1 octave.
 - Manually enter a value in the **Bandwidth** field.
5. The individual Bypass controls allow you to bypass a single band of equalization at a time for more granular A/B testing of a single filter. Set a band's **Bypass** toggle to the right position to bypass that band. Set the toggle to the left position to disable the bypass. By default, **Bypass** is disabled.
6. Each equalizer band has a **Reset** that will reapply the default settings for that band.

Select **Done** to return to the **Settings** tab of the web user interface.

DM NAX Streams

The local inputs of the DM-NAX-2XLRI-1G can be made available as a DM NAX audio-over-IP stream. This single two channel stream will encode XLR input 1 as the left channel, and XLR input 2 as the right channel.

Select **NAX Streams** to expand the tab and display the following information.

NAX Streams

This Device is the Leader PTP Clock Source No

PTP Clock Leader MAC Address 00.10.7f.9c.11e9

PTP Priority

- Transmitters (Autosaved)

Audio Source	Stream	Nax Stream Address	Nax Stream Name	Status	Actions
StreamOut1Ch1	Stream01	0.0.0.0	Stream01c4.42.68.3fb8.ac	Stream Stopped	▶ ⚙

- Receivers (Autosaved)

Zone Name	Stream	Current Stream Address	Requested Stream Address	Status	Actions
StreamIn1Ch1	Stream01	0.0.0.0	0.0.0.0 <input style="font-size: 0.6em;" type="text"/>	Stream Stopped	▶ ⚙

- **Device is Leader PTP Clock Source** indicates whether the DM NAX device's PTP clock is the leader clock on the network. **Yes** will be displayed in green when the local DM-NAX-2XLRI-1G's clock is the PTP leader clock and **No** will be displayed in red when another PTP clock on the network is operating as the leader clock.
- **Leader Clock Status** displays the Leader Clock ID of the device on the network that is currently acting as the leader clock.
- **PTP Priority:** This sets the priority of the local DM NAX device's PTP clock relative to other clocks on the network. The default setting is 254 (one increment higher than the lowest possible value) so that the DM-NAX-2XLRI-1G will only operate as the leader clock if no other PTP leader is present on the network. Valid values range from 1 to 255.

Configure Transmitters

To configure the DM NAX transmit stream:

1. Enter a valid multicast address in the **NAX Stream Address** field.
2. Enter a name in the **NAX Stream Name** field by which the stream can be identified. This stream name is associated with the DM NAX stream's multicast address by other DM NAX or AES67 devices, like a device hostname that resolves to a given IP address.
3. **Status** indicates whether a stream is transmitting or not. When the stream has started or stopped, the **Status** column will update accordingly.
4. Select the configure icon in the **Actions** column. The **Configure** dialog appears:

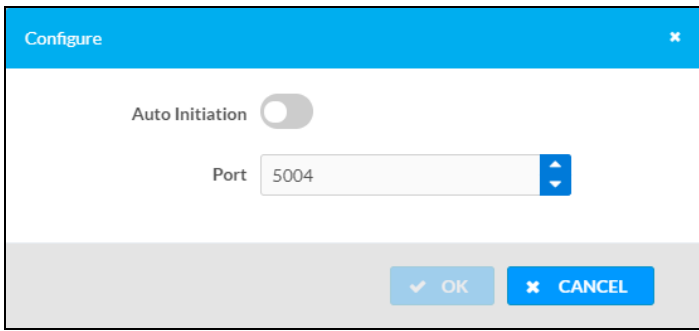

5. Set the **Auto Initiation** toggle to the right position to enable auto initiation. Set the toggle to the left position to disable auto initiation.
 - If **Auto Initiation** is enabled for a given stream, the stream will begin transmitting automatically and will be available as a multicast stream on your network at the specified multicast address.
 - If **Auto Initiation** is disabled for the input, the stream will not begin transmitting until it is manually initiated.
6. To set the port number, do one of the following:
 - Use the arrows to increase or decrease the port number by increments of 1.
 - Manually enter a port number in the **Port** field. The default port number for DM NAX streams is 5004.
7. Select **OK** to save or select **Cancel** to cancel the changes.

Configure Receivers

1. Enter the multicast address of a transmitting stream in the **Requested Stream Address** field to subscribe the receiver to the stream.
2. Select the configure icon  in the **Actions** column. The **Configure** dialog appears:

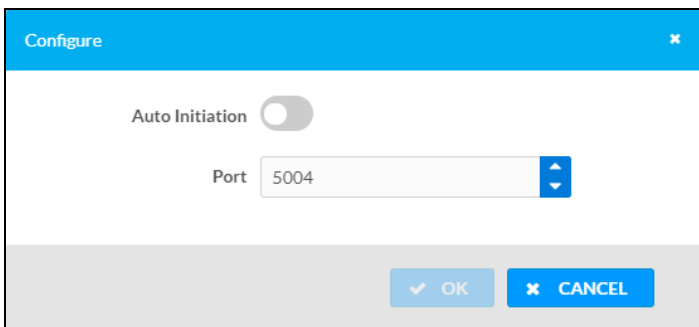

3. Set the **Auto Initiation** toggle to the right position to enable auto initiation. Set the toggle to the left position to disable auto initiation.
 - If **Auto Initiation** is enabled, the stream will begin automatically when the receiver subscribes to the transmitter.
 - If **Auto Initiation** is disabled, the stream will not begin until it is manually initiated.

4. To set the port number, do one of the following:
 - Use the arrows to increase or decrease the port number by increments of 1.
 - Manually enter a port number in the **Port** field. The default port number is 5004.
5. Select **OK** to save or select **Cancel** to cancel the changes.

Mixing

The **Mixing** matrix is used to route a local input or AES67 stream to an output on the DM-NAX-2XLR1-1G.

NOTE: To receive an AES67 stream from Dante devices, see [OLH 1001151](#).

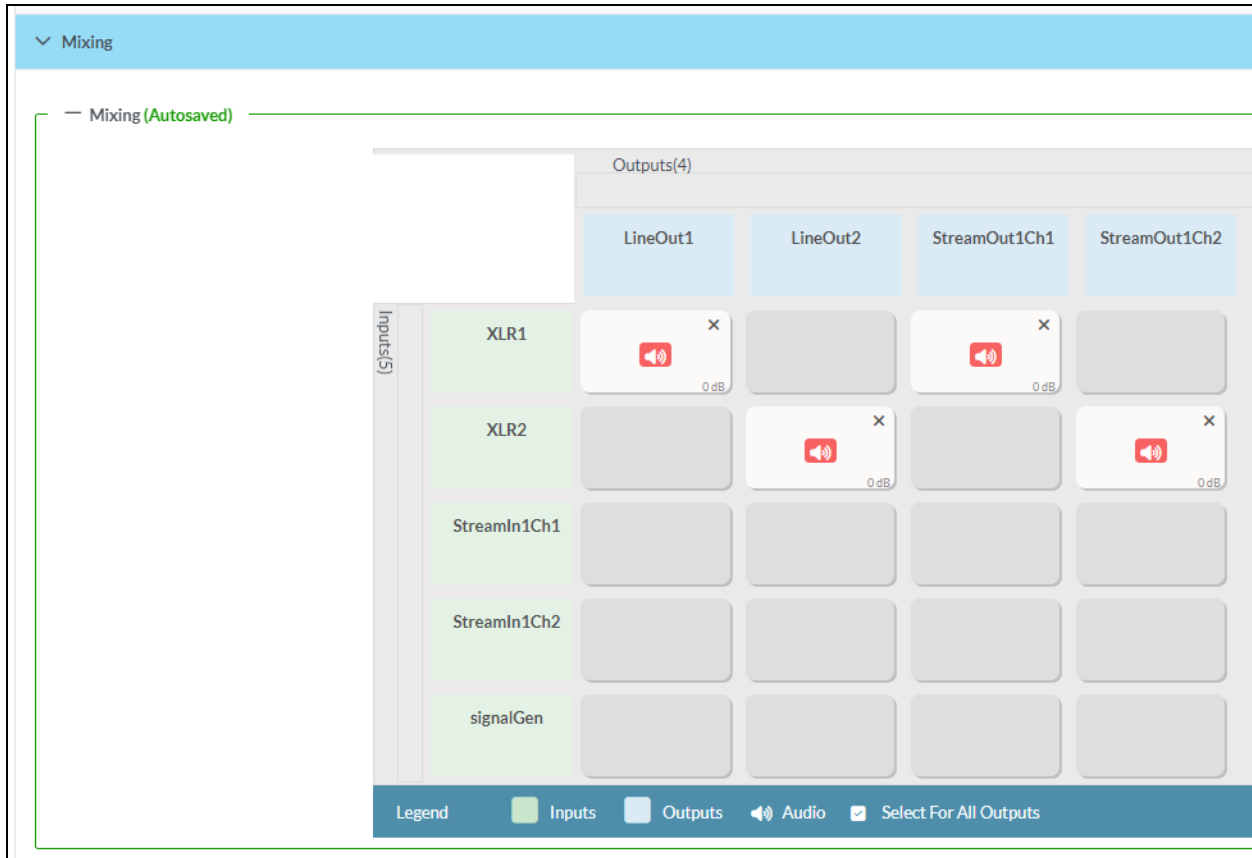

To route inputs to outputs on the device:

- Select the cells corresponding to the desired output that are to be paired for routing. Once a route is made, appears. The input that you have selected for a given row will route to the output corresponding to that row in the matrix.
- To break a given route select or .

Each output can have any number of inputs routed to it. To adjust the mix setting for a route, select the **dB** value of the cell, then do one of the following:

- Move the slider up to increase or down to decrease the mix level.
- Use the arrows to increase or decrease the mix level.

- Manually enter a value in the field.

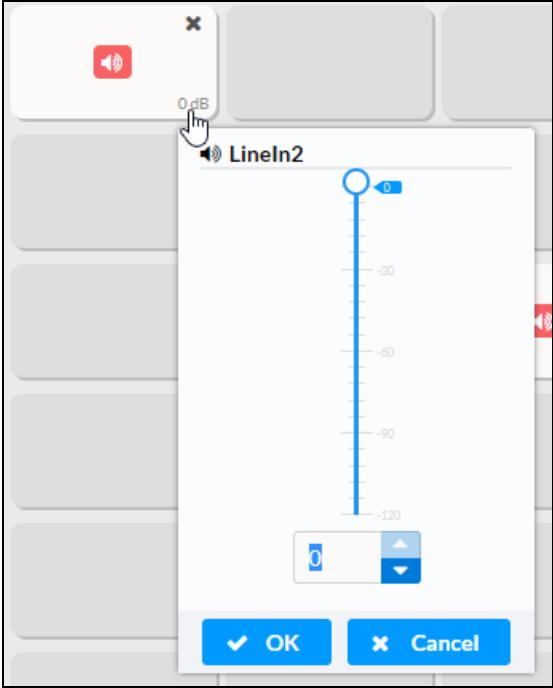

Residential Mode

This section provides the following information:

- [System Setup on page 164](#)
- [Commissioning on page 168](#)
- [Output Channels on page 169](#)
- [Inputs on page 174](#)
- [NAX Streams on page 175](#)
- [Routing on page 178](#)

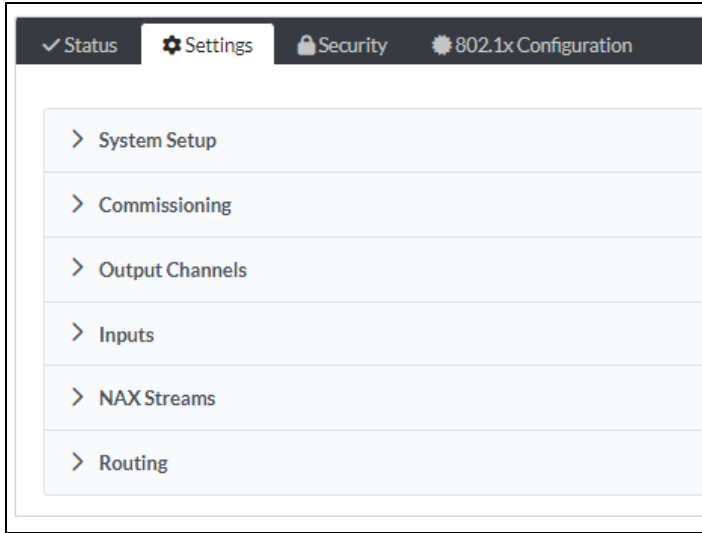

System Setup

The **System Setup** section displays information about the Date/Time, Auto Update, Network, Control System, Cloud Settings, and Device Modes.

Date/Time

Use the **Date/Time** section to configure the date and time settings of the DM-NAX-2XLRI-1G.

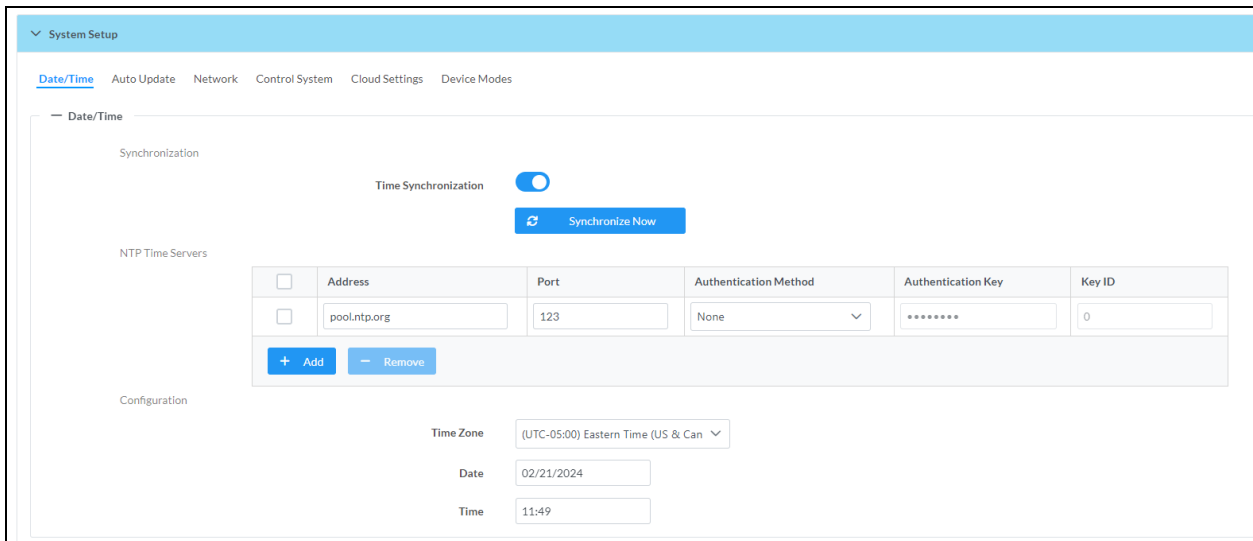

Time Synchronization

1. Set the **Time Synchronization** toggle to the right position to enable or left position to disable time synchronization. By default, time synchronization is enabled.
2. In the **NTP Time Servers** table, enter the URL of a NTP (Network Time Protocol) or SNTP (Simple Network Time Protocol) server. Up to three time servers can be added on a device.
3. Select **Synchronize Now** to perform time synchronization between the device's internal clock and the time server.

Time Configuration

1. Open the **Time Zone** drop-down menu to select the applicable time zone.
2. In the **Date** field, enter the current date.
3. In the **Time (24hr Format)** field, enter the current time in 24-hour format.

Select **Save Changes** to save the settings.

Select **Revert** from the **Action** drop-down menu to revert to the previous settings without saving.

Auto Update

The DM-NAX-2XLRI-1G can automatically check for and install firmware updates at scheduled intervals via the Auto Update feature.

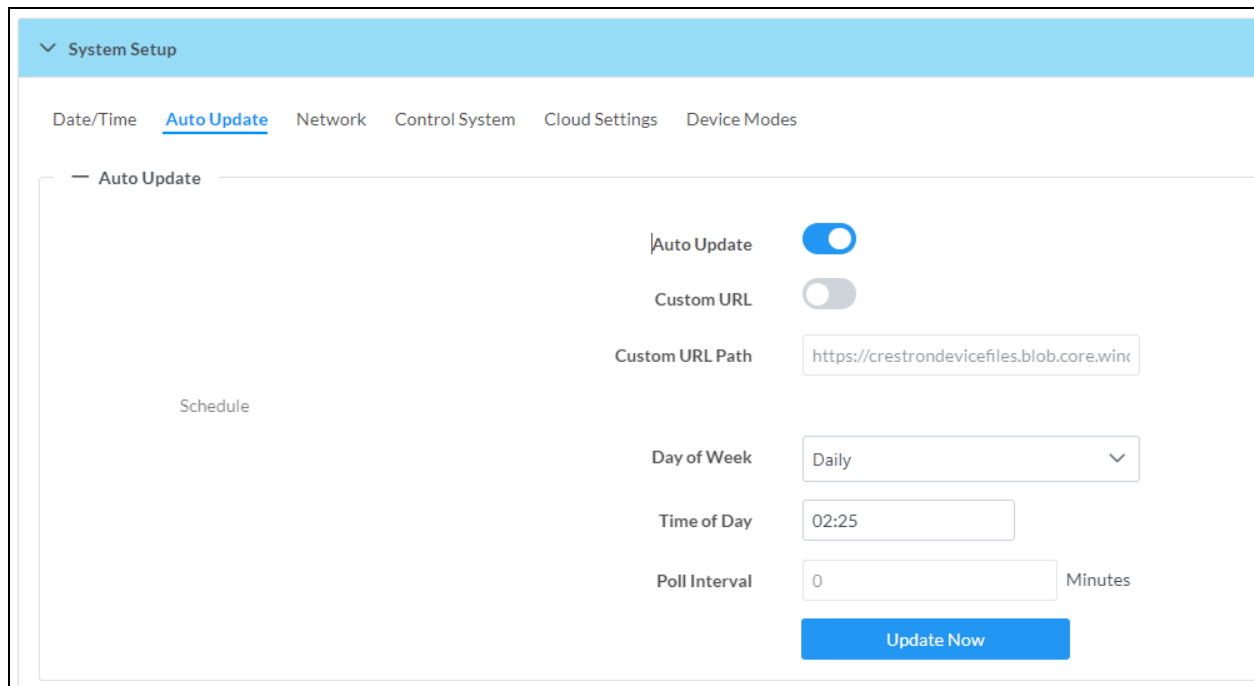

The screenshot shows the 'Auto Update' configuration page within the 'System Setup' menu. The page has a light blue header with 'System Setup' and a sub-header with 'Date/Time', 'Auto Update', 'Network', 'Control System', 'Cloud Settings', and 'Device Modes'. The 'Auto Update' section is active. It features a 'Schedule' area on the left and a configuration area on the right. The configuration area includes: 'Auto Update' (toggle, turned on), 'Custom URL' (toggle, turned off), 'Custom URL Path' (text input field with 'https://crestrondevicefiles.blob.core.win'), 'Day of Week' (dropdown menu with 'Daily' selected), 'Time of Day' (text input field with '02:25'), and 'Poll Interval' (text input field with '0' and 'Minutes' label). A blue 'Update Now' button is at the bottom right.

1. Set the **Auto Update** toggle to the right position to enable Auto Update.
2. Define the URL to download the updates by doing either of the following:

- a. Use the default URL to download the updates from the Crestron server.
 - b. Use a custom URL. Set the **Custom URL** toggle to the right position to enable a custom URL. In the **Custom URL Path** text box, enter the path to a custom manifest file in the FTP or SFTP URL format. Use the Crestron Auto Update Tool to generate a custom manifest file, then store the file on an FTP (File Transfer Protocol) or SFTP (Secure File Transfer Protocol) server.
3. Set a schedule for the automatic firmware update by doing either of the following:
 - a. Select the desired **Day of Week** and **Time of Day** (24-hour format) values.
 - b. Set the **Poll Interval** by entering a value from **60** to **65535** minutes. A value of **0** disables the Poll Interval.
 4. Select **Save Changes**.

Selecting **Update Now** causes the device to check for a firmware update immediately. If a schedule was set in step 4 above, that schedule still remains in effect.

Network

The **Network** section contains network-related settings for the DM-NAX-2XLRI-1G, including the Hostname, Domain, Primary Static DNS, and Secondary Static DNS.

— Network

	Hostname *	<input type="text" value="DM-NAX-2XLRI-1G-C442683FB8AC"/>
	Domain	<input type="text" value="lan"/>
	Primary Static DNS	<input type="text" value="192.168.1.1(DHCP)"/>
	Secondary Static DNS	<input type="text" value=""/>
Adapter 1	DHCP Enabled	<input checked="" type="checkbox"/>
	IP Address	<input type="text" value="192.168.1.231"/>
	Subnet Mask	<input type="text" value="255.255.255.0"/>
	Default Gateway	<input type="text" value="192.168.1.1"/>

NOTE: By default, the host name of the DM-NAX-2XLRI-1G consists of the model name followed by the MAC address of the device. For example, DM-NAX-2XLRI-1G-00107FB58088.

Adapter 1

The Adapter 1 subheading contains settings for DHCP, IP Address, Subnet Mask, and Default Gateway of Ethernet adapter 1 on the rear panel of the device.

NOTE: DM NAX devices' internal processes use IP addresses in the 10.10.10.xxx range. This IP range should be avoided when addressing DM NAX devices to prevent conflicts.

Set the **DHCP** toggle to enabled (right) or disabled (left) to specify whether the IP address of the DM-NAX-2XLRI-1G is to be assigned by a DHCP (Dynamic Host Configuration Protocol) server.

- **Enabled:** When DHCP is enabled (default setting), the IP address of the DM-NAX-2XLRI-1G is automatically assigned by a DHCP server on the local area network (LAN).
- **Disabled:** When DHCP is disabled, manually enter information in the following fields:
 - **Primary Static DNS:** Enter a primary DNS IP address.
 - **Secondary Static DNS:** Enter a secondary DNS IP address.
 - **IP Address:** Enter a unique IP address for the DM-NAX-2XLRI-1G.
 - **Subnet Mask:** Enter the subnet mask that is set on the network.
 - **Default Gateway:** Enter the IP address that is to be used as the network's gateway.

To save any new network entries, select **Save Changes**.

Control System

The screenshot displays the 'Control System' configuration page. At the top, there is a navigation bar with 'System Setup' and several tabs: 'Date/Time', 'Auto Update', 'Network', 'Control System' (which is selected), 'Cloud Settings', and 'Device Modes'. Below the navigation bar, the main content area is titled 'Control System'. It features a blue 'Encrypt Connection' button. Underneath this, there is an 'IP Table' section. The table has three columns: 'IP ID', 'IP Address/Hostname', and 'Room Id'. The table is currently empty, displaying 'No records found'. At the bottom of the table, there are two buttons: '+ Add' and 'x Remove'.

1. Select **Encrypt Connection** to navigate to the **Security** tab to configure encryption settings.
 - a. Enter the username in the **Control System Username** field.
 - b. Enter the password in the **Control System Password** field.
2. Select **+ Add** to add an IP table entry to the **IP Table**.
 - a. Enter the Room ID in the **Room ID** field.
 - b. Enter the IP ID of the DM-NAX-2XLRI-1G in the **IP ID** field.
 - c. Enter the IP address or hostname of the control system in the **IP Address/Hostname** field.
3. Select **Save Changes** to save the new entries. The **Control System Save** message box appears, indicating that the control system settings were saved successfully. Select **Revert** to revert to the previous settings without saving.

Cloud Settings



Set the **Cloud Settings** toggle to enabled (right) or disabled (left) to specify whether the DM-NAX-2XLRI-1G can communicate with the XiO Cloud® platform.

Device Modes

Use the **Device Modes** section to configure the **Application Mode**.

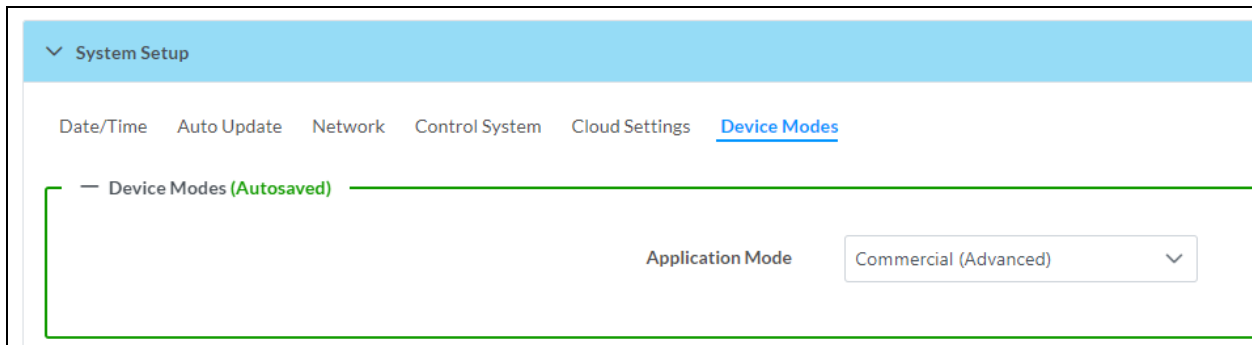

- **Application Mode:** The Application Mode determines which options and controls are available.
 - Select **Residential (Standard)** or **Commercial (Advanced)**. A **Reboot** confirmation message box appears.

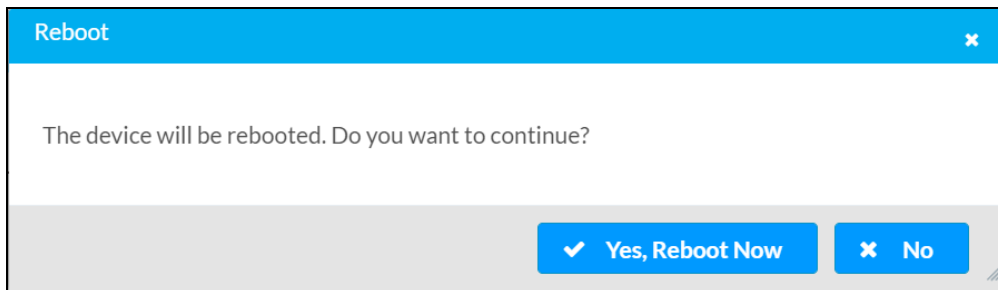

- Select **Yes, Reboot Now** to reboot the device into the selected mode. The **Reboot** message box appears.
- Wait for the device reboot to complete before attempting to reconnect to the device.

Commissioning

The **Commissioning** section provides a quick way to automatically assign multicast addresses to the device's internal audio-over-IP stream transmitters.

Commissioning

Starting Multicast Address: 239.69.19.1

Last Used Multicast Address: 239.69.19.1

Assign Addresses

Select **Assign Addresses** to give each DM NAX transmitter in the DM-NAX-2XLRI-1G a unique multicast address beginning with the specified **Starting Multicast Address**. The valid range for **Starting Multicast Address** is 239.8.0.0 to 239.127.255.254.

NOTE: This will begin transmitting multicast traffic on your network. Refer to [Audio-over-IP Network Design on page 632](#) for details on proper audio-over-IP network management.

Output Channels

The **Output Channels** section contains the **Volume** and **Mute** settings for all zone outputs of the device, as well as a **Configure** option for more advanced settings within each zone.

Output Channels

Zones (Autosaved)

Global Filter

Name	Volume	Mute	Action
LineOut	30 %	Mute	Configure

Give each zone a friendly name using the **Name** column of the **Zones** table. If the device is paired with a control system, these names may be overwritten by the control system's program.

To configure the zone volume, do one of the following:

- Move the **Volume** slider to the right to increase or to the left to decrease the zone volume.
- Use the **%** arrows to increase or decrease the zone volume. Values range from 0 to 100%, adjustable in increments of 1%.
- Manually enter a value in the **Volume** field.

To mute all audio output from a zone, select its respective **Mute**. To unmute the zone, select **Muted**.

Zone Settings

To configure zone settings, select **Configure** (**Configure**). The **Edit Zone** window appears.

Zone

Select **Zone** to access the settings for **Balance**, and **Delay**.

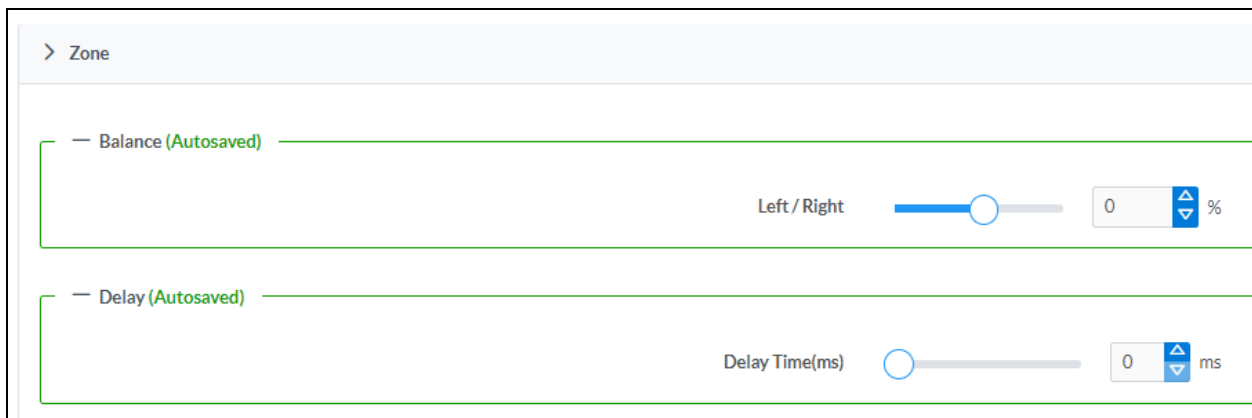

Balance

To adjust the left/right balance of the stereo output signal, do one of the following:

- Move the **Balance** slider to the right to shift the stereo balance to the right channel or to the left to shift the balance to the left.
- Use the arrows to adjust the balance left or right. The up arrow shifts the balance to the right while the down arrow shifts the balance to the left.
- Manually enter a value in the **Balance** field. Values range from -50 to 50, adjustable in increments of 1. Positive values shift the balance to the right while negative values shift the balance to the left.

Delay

To set the delay, do one of the following:

- Move the **Delay Time(ms)** slider to the right to increase or to the left to decrease the delay time.
- Use the **ms** arrows to increase or decrease the delay. Values range from 0 ms to 85 ms, adjustable in increments of 1 ms.
- Manually enter a value in the **Delay Time(ms)** field.

Output

Select **Output** to access the settings for **Minimum/Maximum Volume**, **Stereo/Mono**, **Signal**, **Bussing**, **Volume Offset**, and **Signal Generator**.

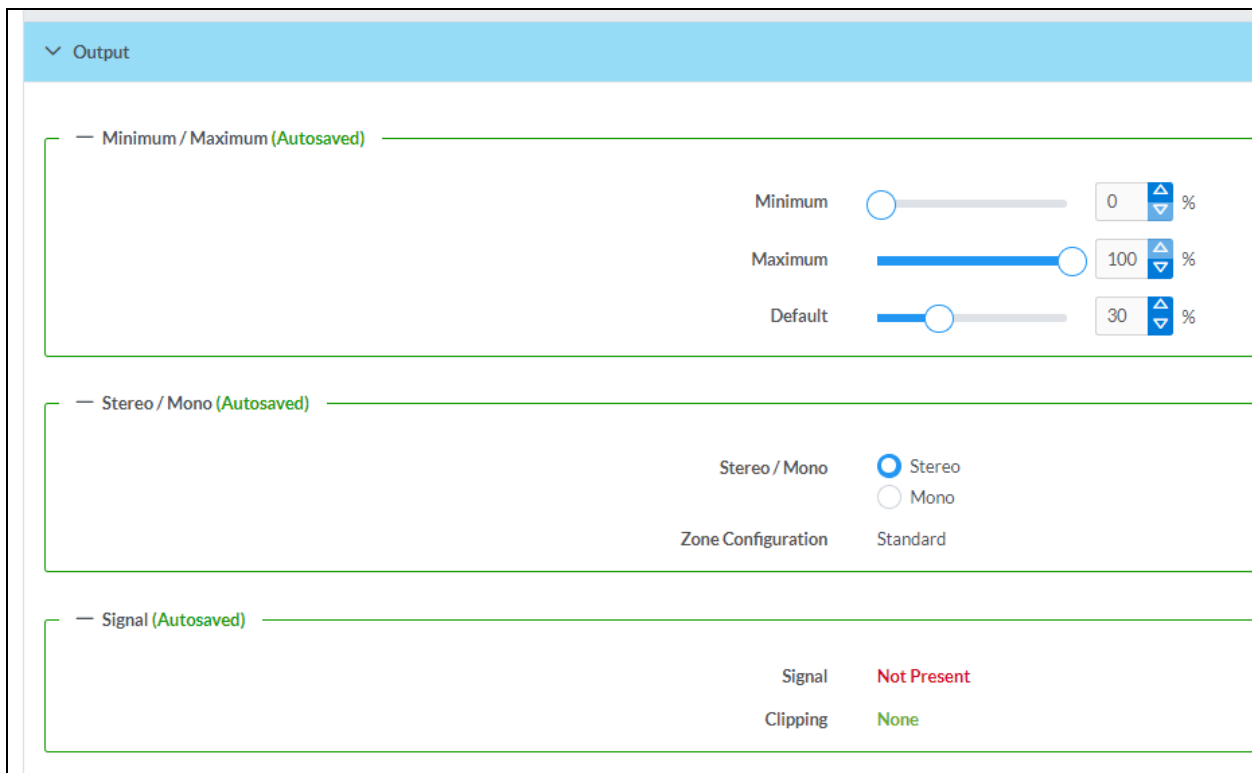

Minimum/Maximum Volume

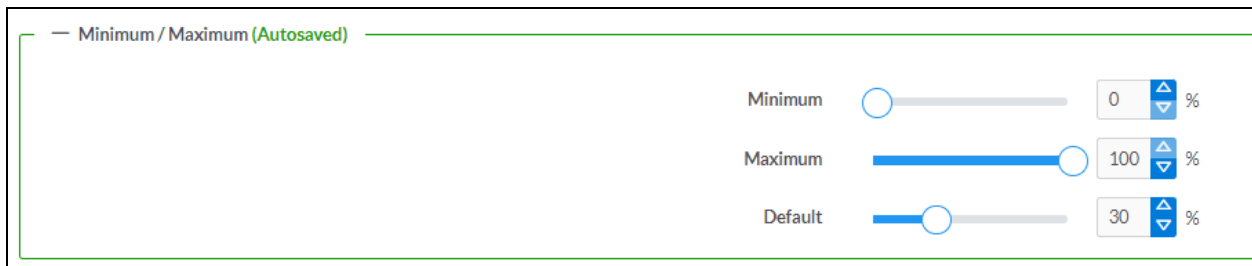

1. To set the minimum volume of the zone, do one of the following:
 - Move the **Minimum** slider to the right to increase or to the left to decrease the minimum volume.
 - Use the **%** arrows to increase or decrease the minimum volume. Values range from 0 to 50%, adjustable in increments of 1%.
 - Manually enter a value in the **Minimum** field.

- To set the maximum volume of the zone, do one of the following:
 - Move the **Maximum** slider to the right to increase or to the left to decrease the maximum volume.
 - Use the **%** arrows to increase or decrease the maximum volume. Values range from 70 to 100%, adjustable in increments of 1%.
 - Manually enter a value in the **Maximum** field.

NOTE: When a **Minimum** and **Maximum** volume are set, the 1-100% range represented by the **Zone** and **Default** volume controls are scaled to the range set. For example, if a **Minimum** of 10% and a **Maximum** of 80% are set for a zone, the 1-100% range of the **Zone** volume control is scaled to the 10%-80% range set as the **Minimum** and **Maximum**.

- To set the default volume of the zone, do one of the following:
 - Move the **Default** slider to the right to increase or to the left to decrease the default volume.
 - Use the **%** arrows to increase or decrease the default volume. Values range from 0 to 50%, adjustable in increments of 1%.
 - Manually enter a value in the **Default** field.

NOTE: The **Default** volume is applied as the **Zone** volume any time the zone receives a source route and no source was previously routed to that zone.

Stereo/Mono

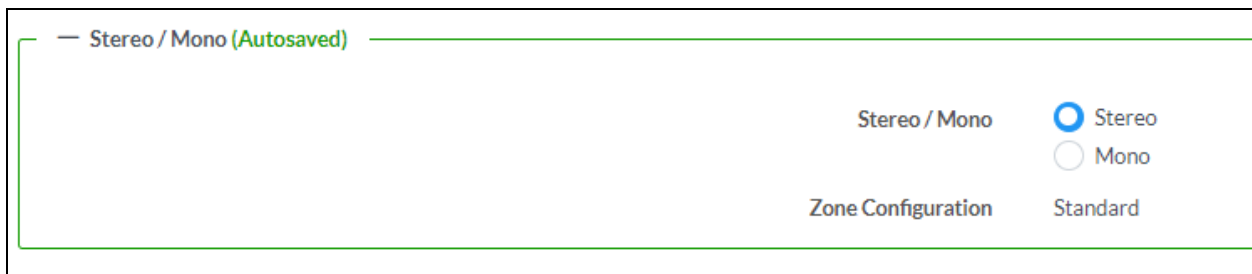

Select either **Stereo** or **Mono**. If **Stereo** is selected, both output channels can have independent audio content. If **Mono** is selected, both output channels receive the same audio content.

Signal

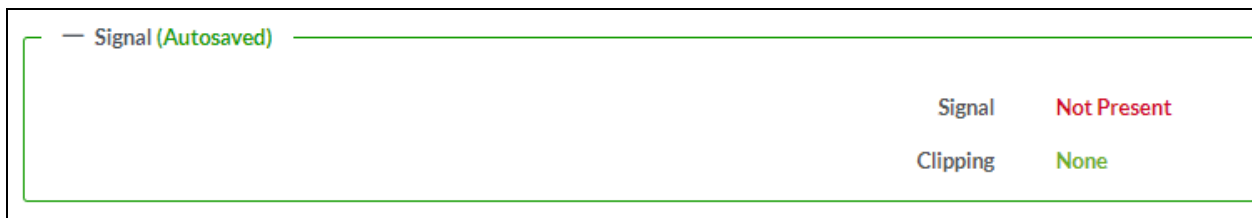

The **Signal** section is a read-only field that displays the **Signal** and **Clipping** status of the zone output.

- If an output signal is present but not clipping, **Signal** will display **Present** in green and **Clipping** will display **None** in green.
- If an output signal is present and clipping, **Signal** will display **Present** in green and **Clipping** will display **Present** in red.
- If no output signal is detected, **Signal** will display **Not Present** in red and **Clipping** will display **None** in green.

Bussing Volume Offset

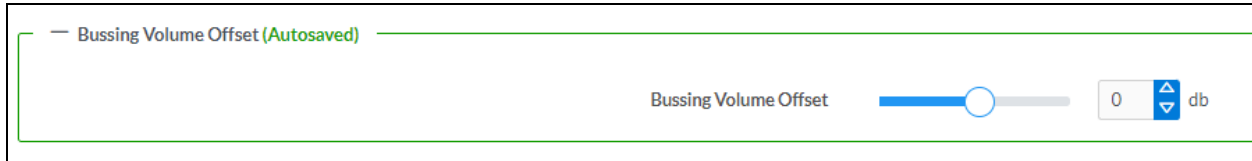

Bussing Volume Offset is an additional level compensation applied to the zone relative to any other zones it is grouped with via the **Bussing** feature.

To set the bussing volume offset, do one of the following:

- Move the **Bussing Volume Offset** slider to the right to increase or to the left to decrease the offset.
- Use the **db** arrows to increase or decrease the offset. Values range from -12 dB to 12 dB, adjustable in increments of 1 dB.
- Manually enter a value in the **Bussing Volume Offset** field.

Signal Generator

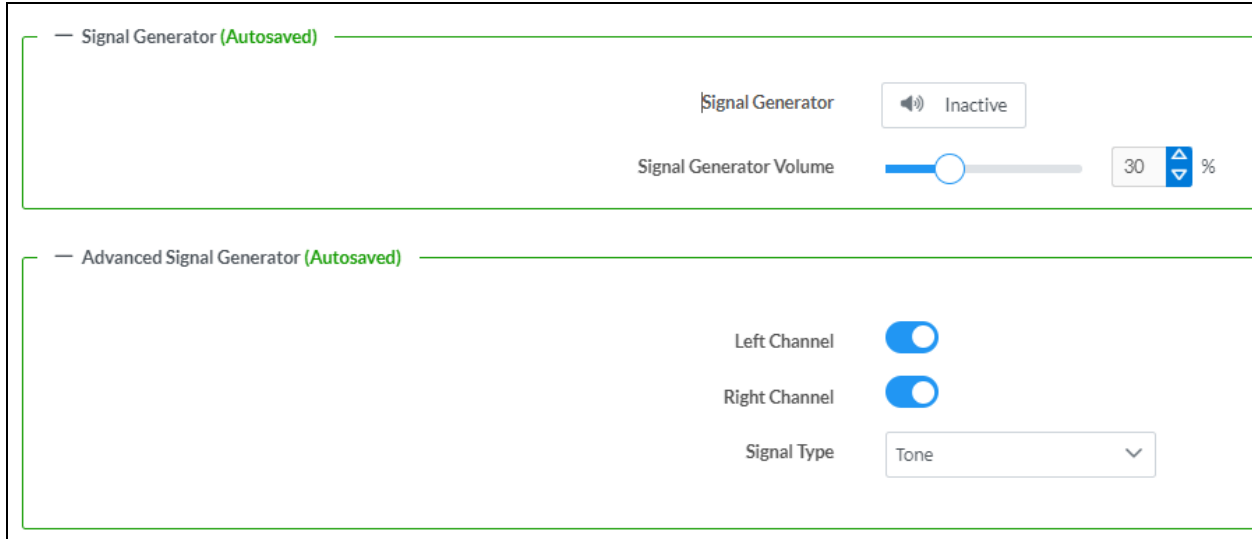

The DM-NAX-2XLRI-1G has a built-in signal generator that allows an integrator to send an audio signal to the output for testing purposes.

1. To route the signal generator to the zone output, select **Signal Generator** so that it displays **Active** and is highlighted in blue. To unroute the signal generator on the zone output, select **Signal Generator** again so that it displays **Inactive** and is highlighted in grey. By default, the signal generator is not routed to the zone output.
2. To adjust the signal generator's volume, do one of the following:
 - Move the **Signal Generator Volume** slider right to increase or left to decrease the volume.
 - Use the arrows to increase or decrease the signal generator volume. Values range from 0 to 100, adjustable in increments of 1.
 - Manually enter a value in the **Signal Generator Volume** field.

Advanced Signal Generator

The advanced signal generator settings control the signal type of the signal generator, and allow the left and right channel to be enabled or disabled independently of one another.

1. Set the **Left Channel** toggle to the right position to enable the left channel of the signal. Set the toggle to the left position to disable the left channel. By default, **Left Channel** is enabled.
2. Set the **Right Channel** toggle to the right position to enable the right channel of the signal. Set the toggle to the left position to disable the right channel. By default, **Right Channel** is enabled.
3. Select an audio test signal type from the **Signal Type** drop-down menu. The available signal types are:
 - **Tone**: Generates a 1 kHz sine wave tone.
 - **Pink Noise**: Generates pink noise.
 - **White Noise**: Generates white noise.

Select **Done** to return to the **Settings** tab of the web user interface.

Inputs

The **Inputs** section is used to configure the **Name**, **Compensation**, and **Mute** attributes of the available analog, digital, and media streaming inputs on the DM-NAX-2XLRI-1G.

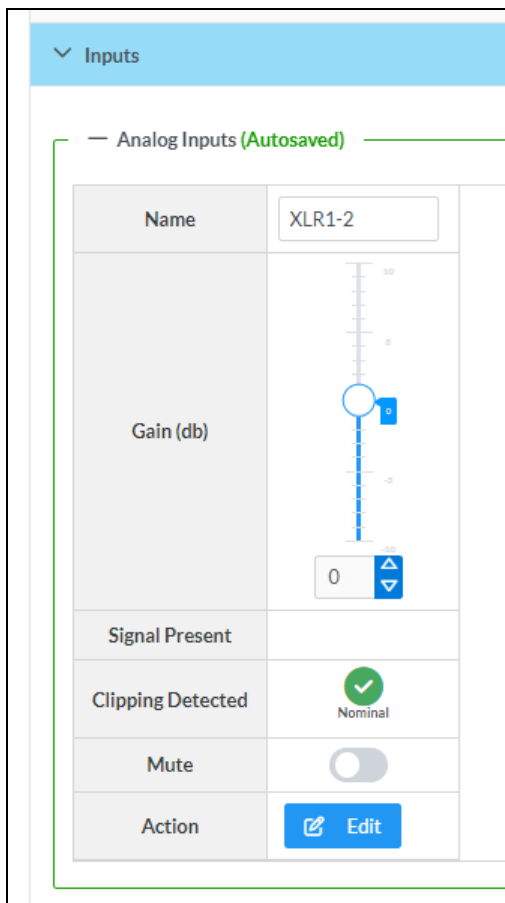

Configure Inputs

1. If needed, enter a friendly name for each input in its **Name** field.
2. To set a level compensation adjustment for a given input, do one of the following:
 - Move the **Compensation** slider up to increase or down to decrease the level compensation. Compensation increases or decreases the level of the incoming audio signal on any of the physical inputs on the device's rear panel.
 - Use the **db** arrows to increase or decrease the compensation. Values range from -10 dB to 10 dB, adjustable in increments of 1 dB.
 - Manually enter a value in the **Compensation** field.
3. To mute the signal from the corresponding input, set the **Mute** toggle to the right. To disable the mute, set the **Mute** toggle to the left. By default, **Mute** is disabled.

Monitor the device's input signals using the text indicators in the **Signal Present** and **Clipping Detected** columns:

- **Signal Presence** indicates whether or not a signal is detected in that zone.
- **Clipping Detected** indicates if the signal is **Clipping** or **Nominal** (non-clipping).

NAX Streams

The local inputs of the DM-NAX-2XLRI-1G can be made available as a DM NAX audio-over-IP stream. This single two channel stream will encode XLR input 1 as the left channel, and XLR input 2 as the right

channel.

Select **NAX Streams** to expand the tab and display the following information.

Audio Source	Stream	Nax Stream Address	Nax Stream Name	Status	Actions
StreamOut1Ch1	Stream01	0.0.0.0	Stream01c4.42.68.3fb8.ac	Stream Stopped	▶ ◻ ⚙

Zone Name	Stream	Current Stream Address	Requested Stream Address	Status	Actions
StreamIn1Ch1	Stream01	0.0.0.0	0.0.0.0	Stream Stopped	▶ ◻ ⚙

- **Device is Leader PTP Clock Source** indicates whether the device is the leader for PTP on the network. **Yes** will be displayed in green when the local DM-NAX-2XLRI-1G is the PTP leader clock and **No** will be displayed in red when another PTP clock on the network is operating as the leader clock.
- **Leader Clock Status** displays the Leader Clock ID of the device on the network that acts as the Leader Clock.
- **PTP Priority**: This sets the priority of the local DM NAX device's PTP clock relative to other clocks on the network. The default setting is 254 (one increment higher than the lowest possible value) so that the DM-NAX-2XLRI-1G will only operate as the leader clock if no other PTP leader is present on the network. Valid values range from 1 to 255.

Configure Transmitters

Audio Source	Stream	Nax Stream Address	Nax Stream Name	Status	Actions
IN1-IN2	Stream01	239.8.0.2	Stream01c4.42.68.18.54.47	Stream Started	▶ ◻ ⚙
IN3-IN4	Stream02	239.8.0.3	Stream02c4.42.68.18.54.47	Stream Started	▶ ◻ ⚙

To configure a DM NAX transmit stream:

1. Enter a valid multicast address in the **NAX Stream Address** field.
2. Enter a name in the **NAX Stream Name** field by which the stream can be identified. This stream name is associated with the DM NAX stream's multicast address by other DM NAX or AES67 devices, like a device hostname that resolves to a given IP address.
3. **Status** indicates whether a stream is transmitting or not. When the stream has started or stopped, the **Status** column will update accordingly.
4. Select the configure icon ⚙ in the **Actions** column. The **Configure** dialog appears:

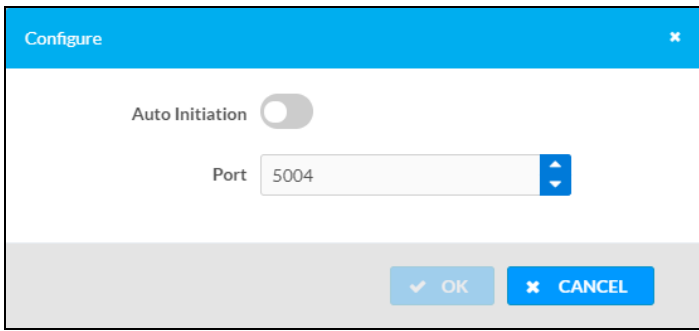

5. Set the **Auto Initiation** toggle to the right position to enable auto initiation. Set the toggle to the left position to disable auto initiation.
 - If **Auto Initiation** is enabled for a given stream, the stream will begin transmitting automatically and will be available as a multicast stream on your network at the specified multicast address.
 - If **Auto Initiation** is disabled for the input, the stream will not begin transmitting until it is manually initiated.
6. To set the port number, do one of the following:
 - Use the arrows to increase or decrease the port number by increments of 1.
 - Manually enter a port number in the **Port** field. The default port number for DM NAX streams is 5004.
7. Select **OK** to save or select **Cancel** to cancel the changes.

Configure Receivers

Zone Name	Stream	Current Stream Address	Requested Stream Address	Status	Actions
Zone_Amp1	Stream01	0.0.0.0	0.0.0.0 <input type="text"/>	Stream Stopped	<input type="button" value="▶"/> <input type="button" value="■"/> <input type="button" value="⚙"/>
Zone_Amp2	Stream02	0.0.0.0	0.0.0.0 <input type="text"/>	Stream Stopped	<input type="button" value="▶"/> <input type="button" value="■"/> <input type="button" value="⚙"/>

1. Enter the multicast address of a transmitting stream in the **Requested Stream Address** field to subscribe the receiver to the stream.
2. Select the configure icon  in the **Actions** column. The **Configure** dialog appears:

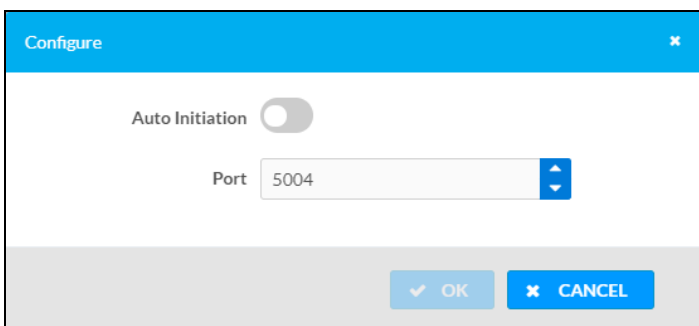





3. Set the **Auto Initiation** toggle to the right position to enable auto initiation. Set the toggle to the left position to disable auto initiation.
 - If **Auto Initiation** is enabled, the stream will begin automatically when the receiver subscribes to the transmitter.
 - If **Auto Initiation** is disabled, the stream will not begin until it is manually initiated.
4. To set the port number, do one of the following:
 - Use the arrows to increase or decrease the port number by increments of 1.
 - Manually enter a port number in the **Port** field. The default port number is 5004.
5. Select **OK** to save or select **Cancel** to cancel the changes.

Routing

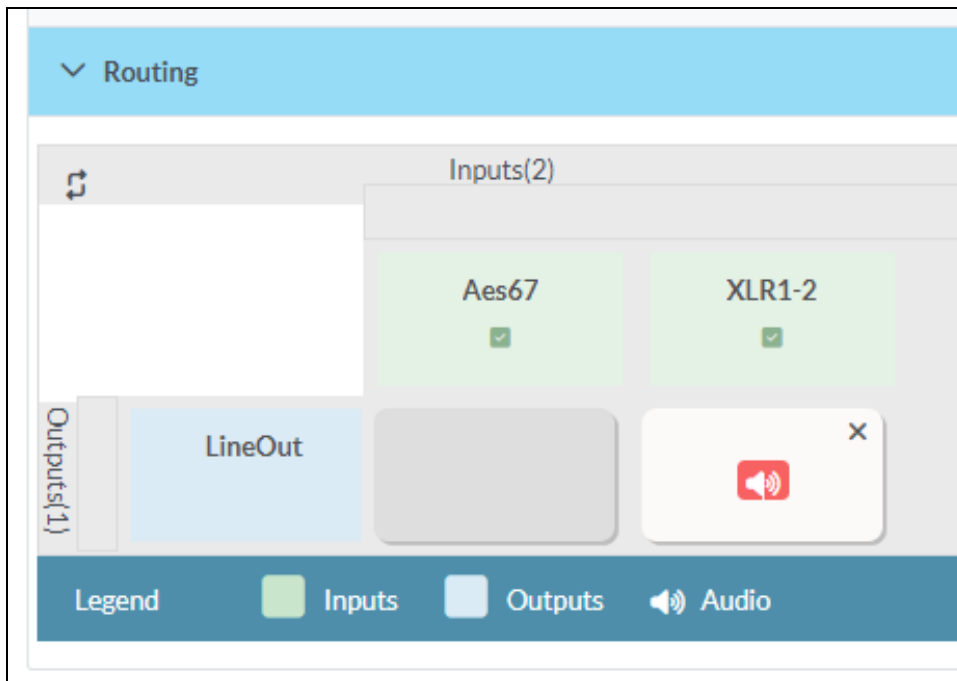
The **Routing** section is used to route a local input or AES67 stream to a Zone on the DM-NAX-2XLRI-1G.

NOTE: To receive an AES67 stream from Dante devices, see [OLH 1001151](#).



- To route an input to a zone, select the box in the routing matrix where the zone's row overlaps the corresponding input's column. Once a route is made,  appears.
- To break a given route select  or .
- To route a single input to all zones, select the  icon under the input's name.

Security

Select the **Security** tab to configure security for users and groups and to allow different levels of access to the DM-NAX-2XLRI-1G functions. By default, security is disabled.

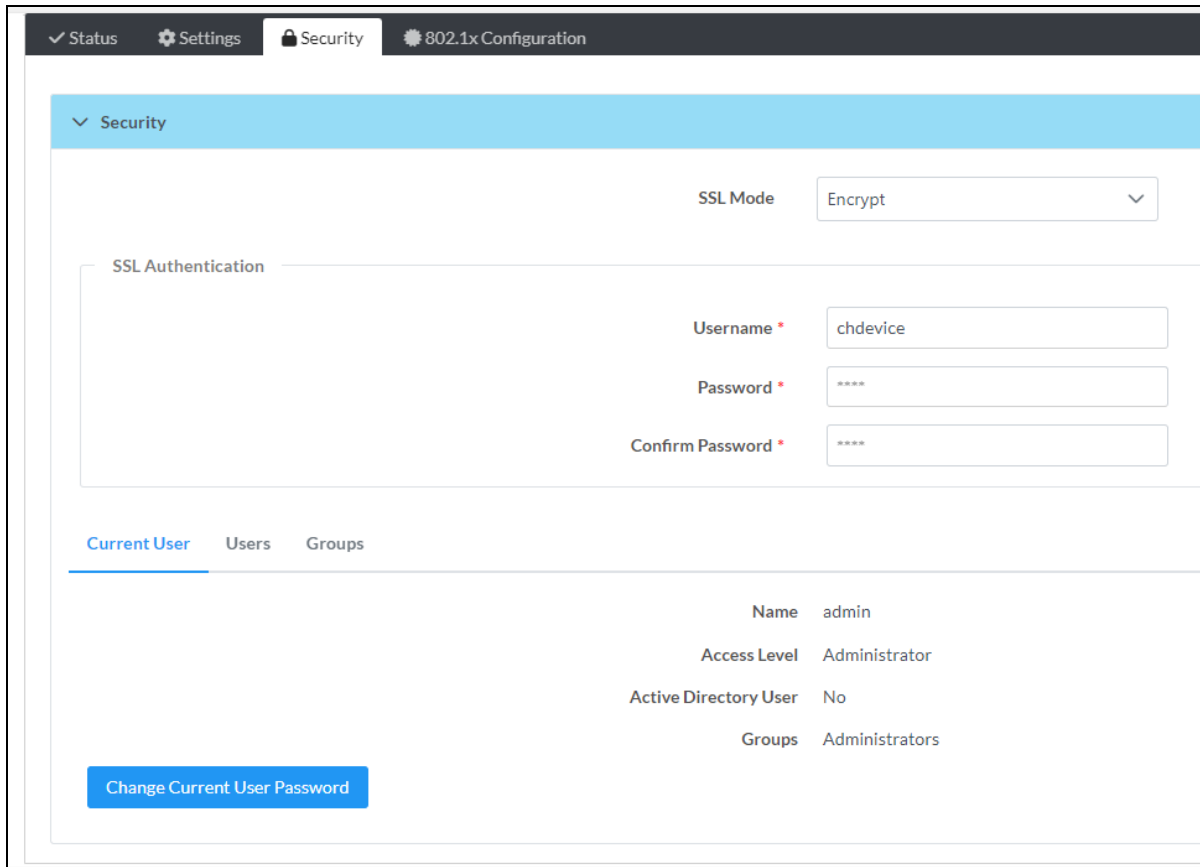

Select **Encrypt and Validate**, **Encrypt**, or **OFF** in the **SSL Mode** drop-down menu, to specify whether to use encryption. By default, SSL Mode is set to **OFF**.

Current User

Select the **Current User** tab to view read-only information or to change the password for the current user.

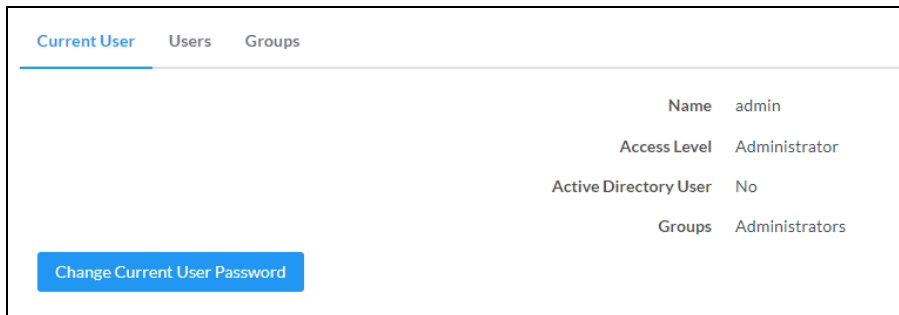

1. Select **Change Current User Password** to provide a new password for the current user.
2. In the **Change Password** dialog, enter the current password in the **Current Password** field, the new password in the **Password** field, and then re-enter the same new password in the **Confirm Password** field.

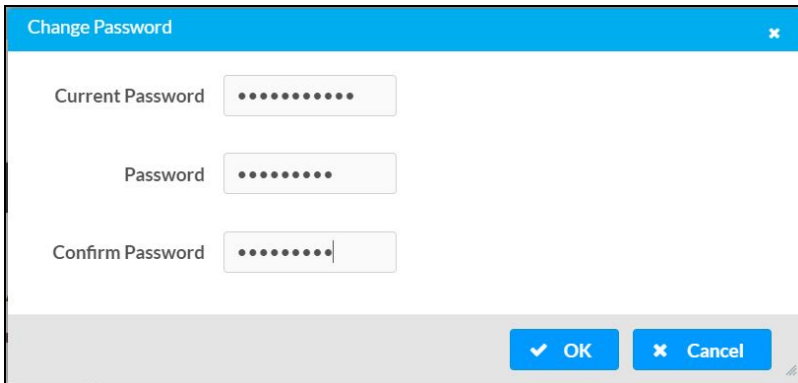

The image shows a 'Change Password' dialog box with a blue header and a close button. It contains three password input fields: 'Current Password', 'Password', and 'Confirm Password'. Each field is filled with dots. At the bottom, there are two buttons: 'OK' with a checkmark icon and 'Cancel' with an 'X' icon.

3. Select **OK** to save or select **Cancel** to cancel the changes.

Users

Select the **Users** tab to view and edit user settings. The **Users** tab can be used to add or remove local and Active Directory users and preview information about users.

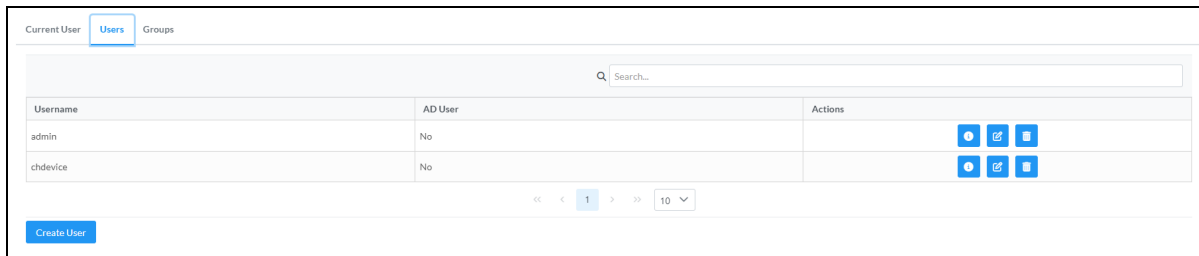

The image shows the 'Users' management interface. It has tabs for 'Current User', 'Users', and 'Groups'. A search bar is at the top. Below it is a table with columns for 'Username', 'AD User', and 'Actions'. The table lists two users: 'admin' and 'chdevice', both with 'AD User' status set to 'No'. The 'Actions' column for each user contains three icons: a magnifying glass, a document with a pencil, and a trash can. At the bottom of the table, there are navigation arrows and a page number '1' in a box, followed by a drop-down menu showing '10'.

Username	AD User	Actions
admin	No	[Icons]
chdevice	No	[Icons]

Use the **Search Users** field to enter search term(s) and display users that match the search criteria.

If users listed in the **Users** table span across multiple pages, navigate through the list of users by selecting a page number or by using the left or right arrows at the bottom of the **Users** pane to move forward or backward through the pages.

Each page can be set to display 5, 10, or 20 users by using the drop-down menu to the right of the navigation arrows.

Information about existing users is displayed in table format and the following details are provided for each user.

- **Username:** Displays the name of the user.
- **AD User:** Displays whether the user requires authentication using Active Directory.

Select the corresponding icon in the Actions column to view detailed user information or to delete the user.

To create a new user, select **Create User**.

Create a New Local User

1. Select **Create User** in the **Users** tab.
2. In the **Create User** dialog, enter the following:

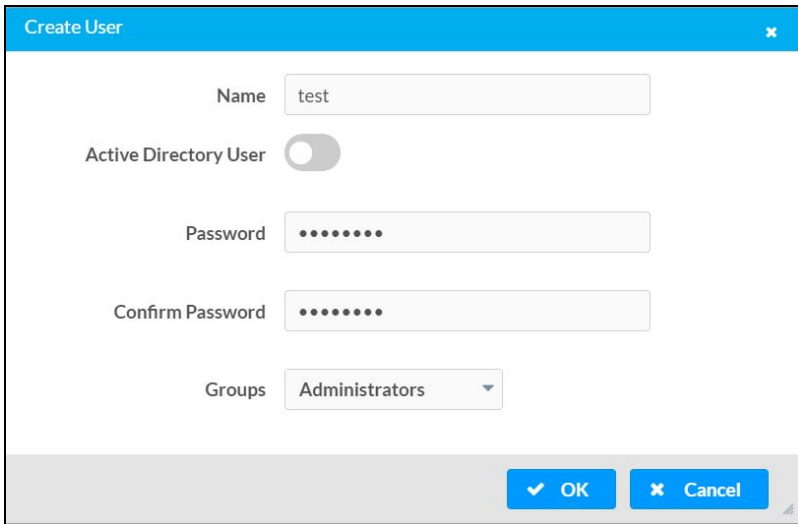

- a. Enter a user name in the **Name** field. A valid user name can consist of alphanumeric characters (letters a-z, A-Z, numbers 0-9) and the underscore "_" character.
- b. Enter a password in the **Password** field; re-enter the same password in the **Confirm Password** field.
- c. Assign the access level by selecting one or more groups from the **Groups** drop-down list.

NOTE: Make sure that the **Active Directory User** toggle is disabled.

3. Select **OK** to save or select **Cancel** to cancel the changes.

Add an Active Directory User

Users cannot be created or removed from the Active Directory server, but access can be granted to an existing user in the Active Directory server.

To grant access to an Active Directory user, you can either add the user to a local group on the DM-NAX-2XLRI-1G, or add the Active Directory group(s) that they are a member of to the DM-NAX-2XLRI-1G.

To add an Active Directory user.

1. Select **Create User**.
2. In the **Create User** dialog, enter the following.

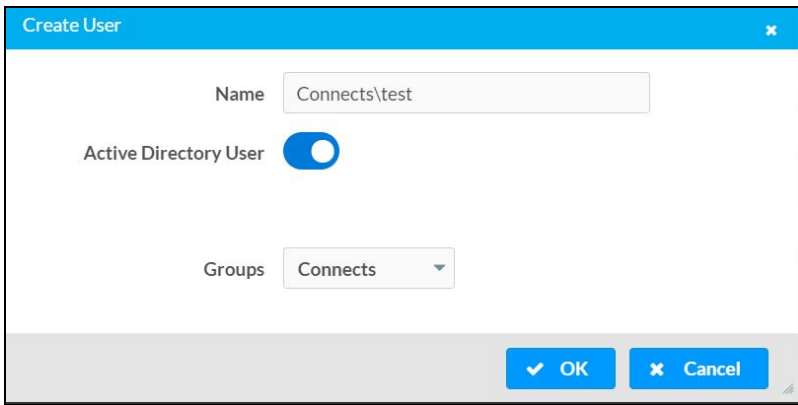

- a. Enter a user name in the **Name** field in the format "Domain\UserName", for example "crestronlabs.com\JohnSmith". Valid user names can contain alphanumeric characters (letters a-z, A-Z, numbers 0-9) and the underscore "_" character.
- b. Select one or more groups from the **Groups** drop-down list.

NOTE: Make sure that the **Active Directory User** toggle is set to enabled.

3. Select **OK** to save or select **Cancel** to cancel the changes.

Delete User

Select the trashcan icon  in the **Actions** column to delete the user. Select **Yes** when prompted to delete the user or **No** to cancel the deletion.

After a user is removed from a group, they lose any access rights associated with that group. Note that the user account is not deleted by the delete user operation.

View User Details

Select the information icon  in the **Actions** column to view information for the selected user. The **User Details** dialog displays the following information for the selected user.

- **Name:** Displays the name of the selected user.
- **Active Directory User:** Displays whether the user is an Active Directory user.
- **Group:** Displays group(s) the selected user is part of.

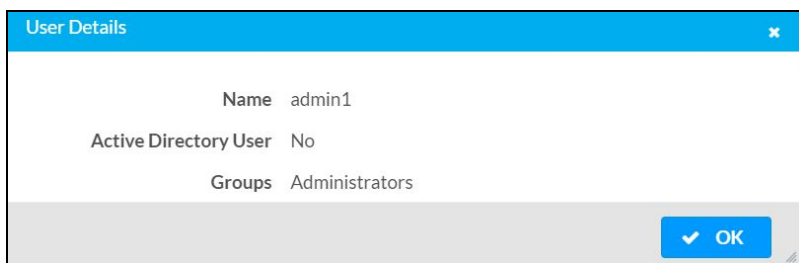

Select **OK** to close the **User Details** dialog and to return to the **Users** tab.

Update User Details

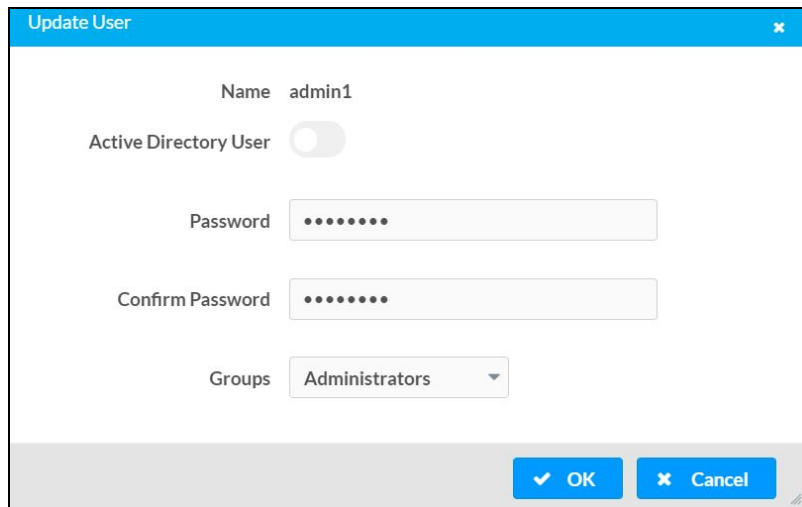

1. Select the edit icon  in the **Actions** column to update information for the selected user.
2. Enter a password in the **Password** field; re-enter the same password in the **Confirm Password** field.
3. Select one or more groups to assign the user to from the **Groups** drop-down list.
4. Select **OK** to save or select **Cancel** to cancel the changes.

The **Update User** dialog also displays the following read-only information for the selected user.









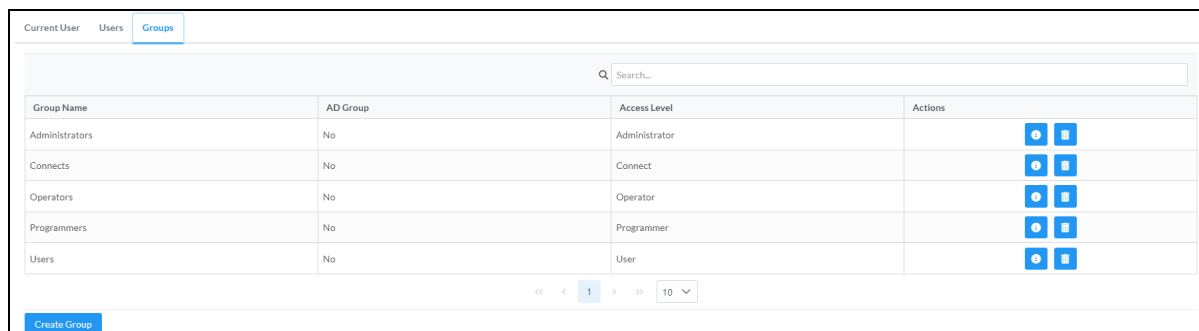

- **Name:** Displays the name of the user.
- **Active Directory User:** Displays whether the user is an Active Directory user.

Groups

Select the **Groups** tab to view and edit group settings. The **Groups** tab can be used to add local and Active Directory groups, remove local and Active Directory groups, and preview information about a group.

Use the **Search Groups** field to enter search term(s) and display groups that match the search criteria.





Group Name	AD Group	Access Level	Actions
Administrators	No	Administrator	 
Connects	No	Connect	 
Operators	No	Operator	 
Programmers	No	Programmer	 
Users	No	User	 

If groups listed in the **Groups** table span across multiple pages, navigate through the groups by selecting a page number or by using the left or right arrows at the bottom of the **Groups** pane to move forward or backward through the pages.

Additionally, each page can be set to display 5, 10, or 20 groups by using the drop-down menu to the right of the navigation arrows.

Existing groups are displayed in a table and the following information is provided for each group:

- **Group Name:** Displays the name of the group.
- **AD Group:** Displays whether the group requires authentication using Active Directory.
- **Access Level:** Displays the predefined access level assigned to the group (Administrator, Programmer, Operator, User, or Connect).

Select the corresponding icon in the **Actions** column to view detailed group information  or to delete  the selected group.

Select **Create Group** in the **Groups** tab to create a new group.

Create Local Group

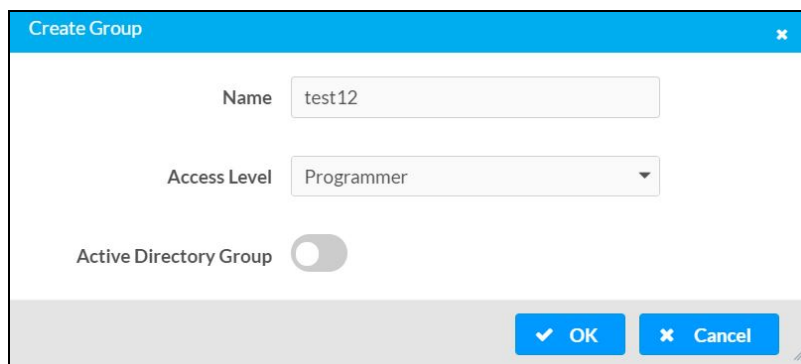

1. Select **Create Group**.
2. In the **Create Group** dialog, enter the following:
 - a. Enter the group name in the **Name** field.
 - b. Assign the group access level by selecting a predefined access level (Administrator, Connect, Operator, Programmer, User) from the **Access Level** drop-down list.

NOTE: Make sure that the **Active Directory Group** toggle is disabled.

3. Select **OK** to save. Select **Cancel** to cancel the changes.

Add Active Directory Group

A group cannot be created or removed from the Active Directory server, but access can be granted to an existing group in Active Directory.

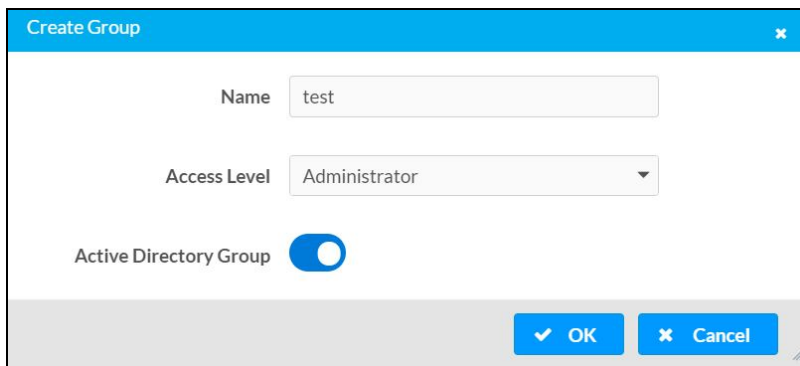

Once the group is added, all members of that group will have access to the DM-NAX-2XLRI-1G.

1. Select **Create Group**.
2. In the **Create Group** dialog enter the following:
 - a. Enter the group name in the **Name** field, for example "Engineering Group". Note that group names are case sensitive; a space is a valid character that can be used in group names.
3. Assign the group access level by selecting a predefined access level (Administrator, Connect, Operator, Programmer, User) from the **Access Level** drop-down list.

NOTE: Make sure that the **Active Directory Group** toggle is enabled.

4. Select **OK** to save. Select **Cancel** to cancel the changes.

Delete a Group

Select the trashcan icon  in the **Actions** column to delete a group. Select **Yes** when prompted to delete the group or **No** to cancel the deletion.

When a group is deleted, users in the group are not removed from the device or Active Directory server. However, because a user's access level is inherited from a group(s), users within the deleted group will lose access rights associated with the group.

View Group Details

Select the information icon  in the **Actions** column to view information for the selected group. The **Group Details** dialog lists the following information for the selected group.

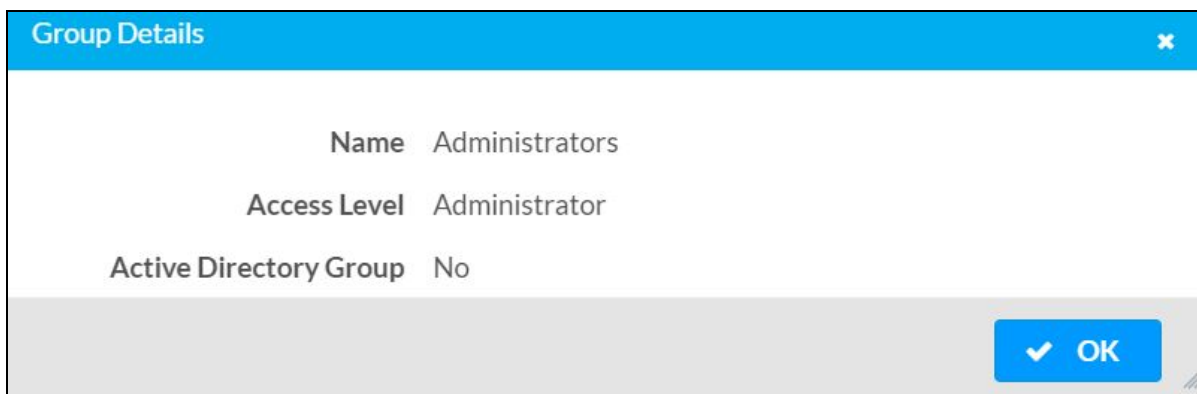

- **Name:** Displays the name of the group.
- **Access Level:** Displays the access level of the group and its users.
- **Active Directory Group:** Displays whether the group is an Active Directory group.

Select **OK** to close the **Group Details** dialog and to return to the **Groups** tab.

802.1x Configuration

The DM-NAX-2XLRI-1G has built-in support for the 802.1X standard (an IEEE network standard designed to enhance the security of wireless and Ethernet LANs. The standard relies on the exchange of messages between the device and the network's host, or authentication server), allowing communication with the authentication server and access to protected corporate networks.

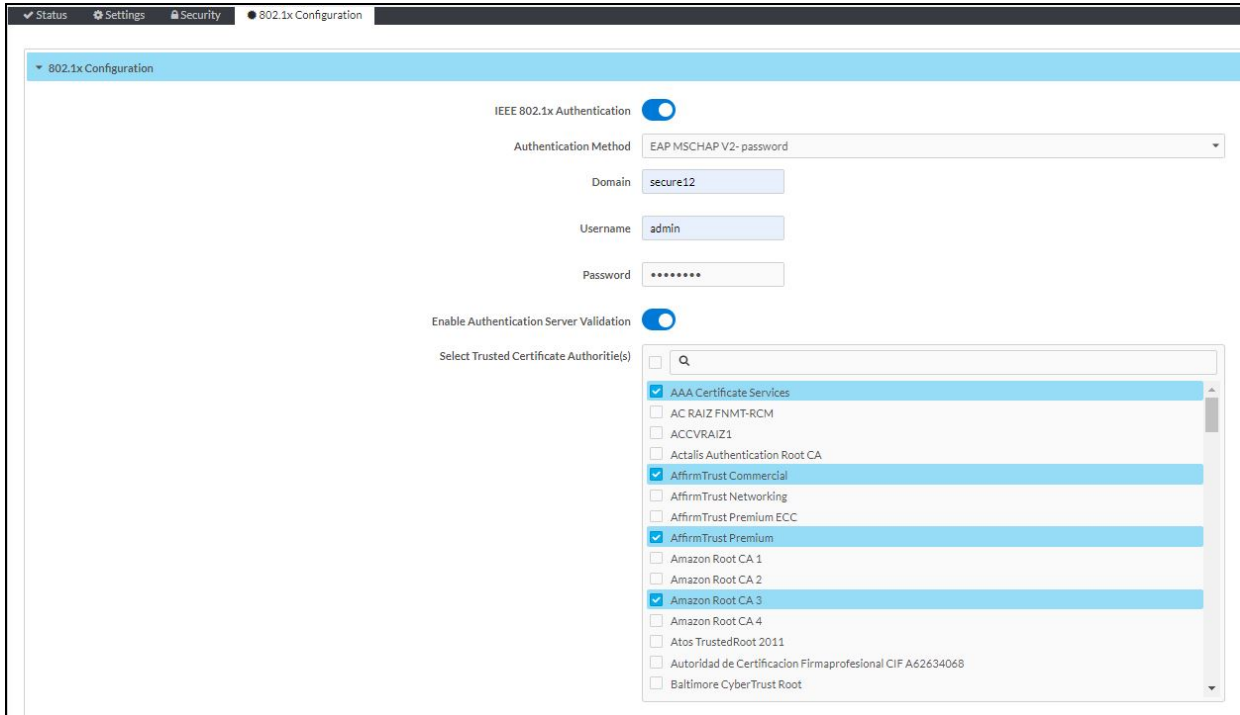

Configure DM-NAX-2XLRI-1G for 802.1X Authentication

1. Set the **IEEE 802.1X Authentication** toggle to enabled. This will enable all options on the 802.1X dialog.
2. Select the **Authentication method: EAP-TLS Certificate** or **EAP-MSCHAP V2 Password** according to the network administrator's requirement.
3. Do either one of the following:
 - Select **EAP-TLS Certificate**: Select **Action/Manage Certificates** to upload the required machine certificate. The machine certificate is an encrypted file that will be supplied by the network administrator, along with the certificate password.
 - Select **EAP-MSCHAP V2 Password**: Enter the username and password supplied by the network administrator into the **Username** and **Password** fields. This method does not require the use of a machine certificate, only the user name and password credentials.
4. If you enabled the **Enable Authentication Server Validation** option, this will enable the **Select Trusted Certificate Authority(ies)** list box which contains signed Trusted Certificate Authorities (CAs) preloaded into the DM-NAX-2XLRI-1G.

Select the check box next to each CA whose certificate can be used for server validation, as specified by the network administrator.

If the network does not use any of the listed certificates, the network administrator must provide a certificate, which must be uploaded manually via the **Manage Certificates** functionality.

5. If required, type the domain name of the network in the **Domain** field.
6. When the 802.1X settings are configured as desired, select **Save Changes** to save the changes to the device and reboot it. Select **Revert** to cancel any changes.

DM-NAX-8ZSA

This section describes how to configure the DM-NAX-8ZSA.

Web Interface Configuration

The DM-NAX-8ZSA web interface allows you to view status information and configure network and device settings.

Access the Web Interface

To access the web interface, do either of the following:

- [Access the Web Interface with a Web Browser on page 190](#)
- [Access the Web Interface With the Crestron Toolbox™ Application on page 192](#)

The web interface is accessed from a web browser. The following table lists operating systems and their corresponding supported web browsers.

Operating System and Supported Web Browsers

OPERATING SYSTEM	SUPPORTED WEB BROWSERS
Windows® operating system	Chrome™ web browser, version 31 and later Firefox® web browser, version 31 and later Internet Explorer web browser, version 11 and later Microsoft Edge web browser
macOS® operating system	Safari® web browser, version 6 and later Chrome web browser, version 31 and later Firefox web browser, version 31 and later

Access the Web Interface with a Web Browser

1. Enter the IP address of the DM-NAX-8ZSA into a web browser.

NOTE: To obtain the IP address, use the **Device Discovery Tool** option in Crestron Toolbox™ application or an IP scanner application.

2. If you are creating a user account for the first time, do the following; otherwise, skip to step 3.
 - a. Enter a username in the **Username** field.
 - b. Enter a password in the **Password** field.
 - c. Re-enter the same password in the **Confirm Password** field.

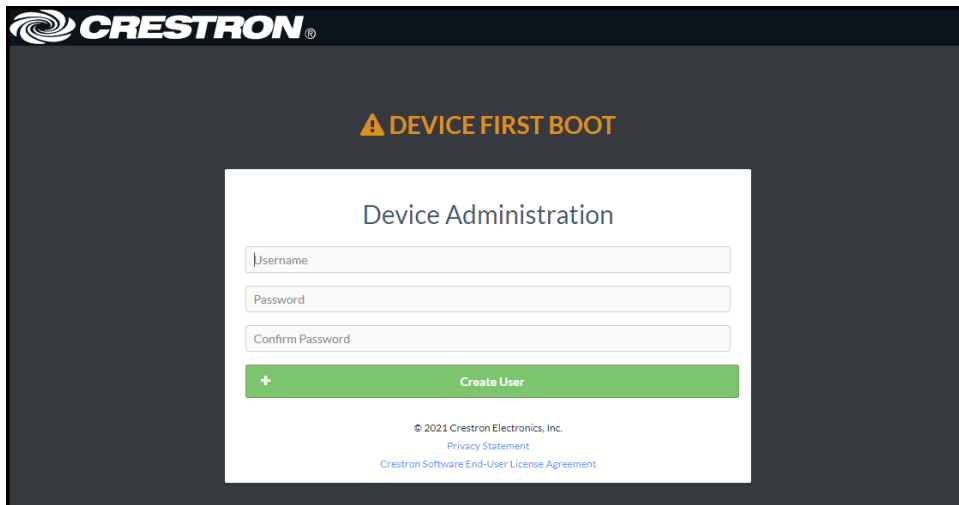

- d. Select **Create User**. The Device Administration page appears.

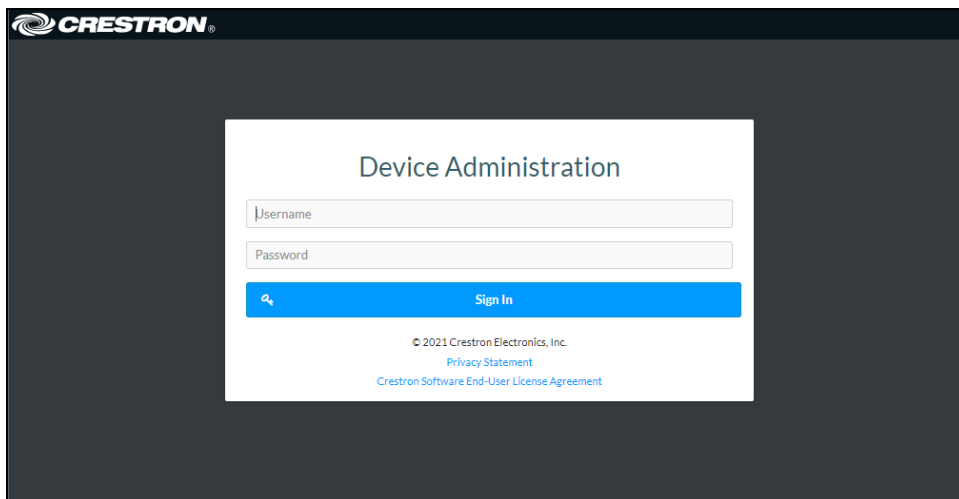

3. Enter the username in the **Username** field.
4. Enter the password in the **Password** field.
5. Select **Sign In**.

Access the Web Interface With the Crestron Toolbox™ Application

To access the web interface by opening a web browser from the Crestron Toolbox™ application:

1. Open the Crestron Toolbox application.
2. From the **Tools** menu, select **Device Discovery Tool**. You can also access the Device Discovery Tool by selecting the Device Discovery Tool icon  in the Crestron Toolbox toolbar. The DM-NAX-8ZSA is discovered and listed in the device list on the left side of the screen. The associated host name, IP address, and firmware version are also displayed.

NOTE: If there is security software running on the computer, a security alert might be displayed when the Crestron Toolbox application attempts to connect to the network. Make sure to allow the connection, so that the Device Discovery Tool can be used.

3. In the Device Discovery Tool list, select the device.
4. Enter the device credentials in the **Authentication Required** dialog that opens, then select **Log In**.
5. Select **Web Configuration**.

Action

The **Action** drop-down menu is displayed at the top right side of the interface and provides quick access to common device functions:

- [Save Changes on page 193](#)
- [Revert on page 193](#)
- [Reboot on page 194](#)
- [Restore to Factory Default Settings on page 194](#)
- [Update Firmware on page 194](#)
- [Download Logs on page 195](#)
- [Manage Certificates on page 195](#)
- [Manage Audio Profiles on page 197](#)
- [Download Configuration on page 198](#)
- [Upload Configuration on page 198](#)

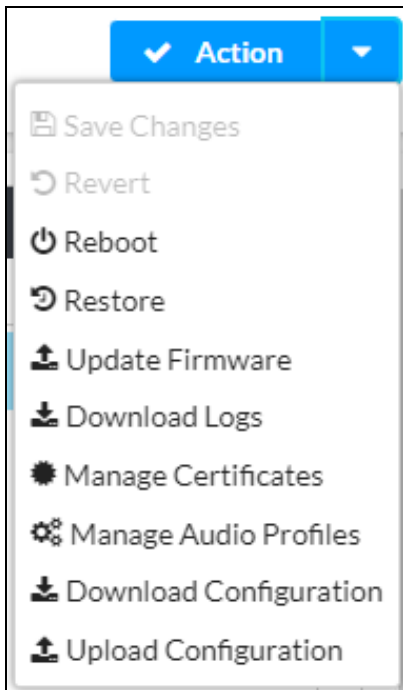

Save Changes

Select **Save Changes** to save any changes made to the configuration settings.

Revert

Select **Revert** to revert the device back to the last saved configuration settings.

Reboot

Certain changes to the settings may require the DM-NAX-8ZSA to be rebooted to take effect. To reboot the device:

1. Select **Reboot** in the **Action** drop-down menu. The **Confirmation** message box appears.

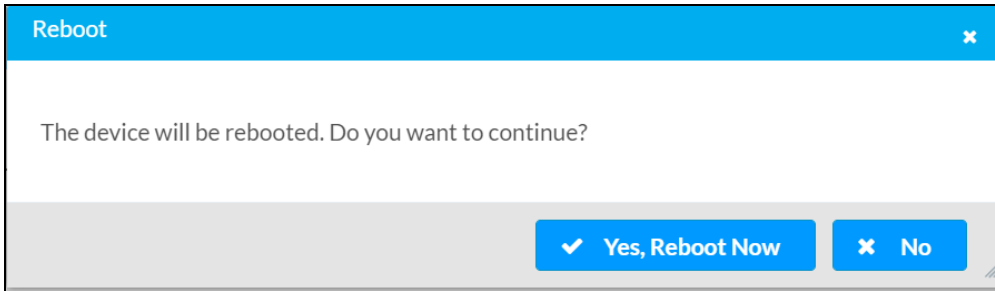

2. Select **Yes, Reboot Now** to reboot the device. The **Reboot** message box appears. Wait for the device reboot to complete before attempting to reconnect to the device.

Restore to Factory Default Settings

1. Select **Restore** in the **Action** drop-down menu to restore the settings of the DM-NAX-8ZSA to factory defaults.

NOTE: When settings are restored, all settings, including the network settings, will revert to the factory default. If a static IP address is set, restoring the device to factory default settings will revert the IP address to the default DHCP mode.

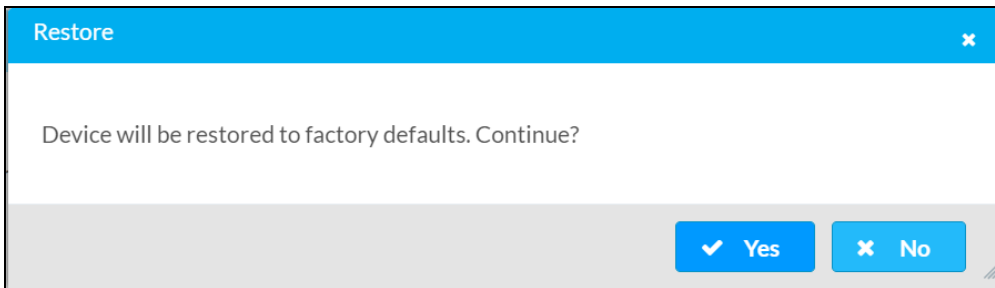

2. Select **Yes** in the **Confirmation** dialog to restore the DM-NAX-8ZSA to factory settings. Select **No** to cancel the restore operation.

A dialog is displayed again, indicating that the restore process was successful and that the device rebooted.

You can also restore to factory settings by pressing and holding the **SETUP** button on the rear panel of the device with power disconnected then connect the power supply and continue to hold **SETUP** button for 30 seconds.

Update Firmware

1. Select **Update Firmware** in the **Action** drop-down menu.
2. In the **Firmware Upgrade** dialog, select **+ Browse**.

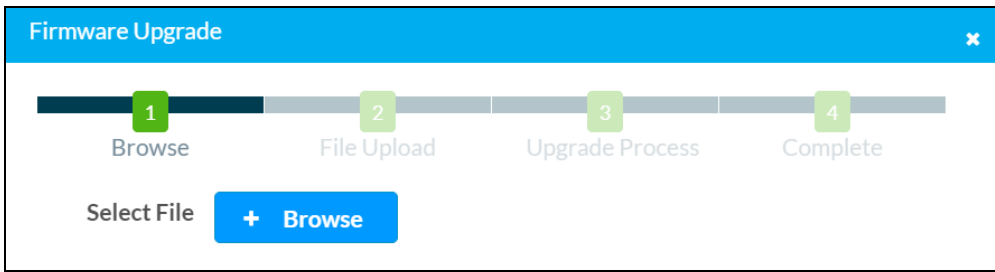

3. Locate and select the desired firmware file, and then select **Open**. The selected firmware file name is displayed in the **Firmware Upgrade** dialog.
4. Select **Load** and wait for the progress bar to complete and for **OK** to become selectable.
5. Select **OK**. The device with new firmware can now be accessed.

Download Logs

Select **Download Logs** in the **Action** drop-down menu to download the device message logs for diagnostic purposes.

The log file is downloaded to the Downloads folder of the PC.

Manage Certificates

Use the **Manage Certificates** dialog to add, remove, and manage certificates used in 802.1x and other protected networks.

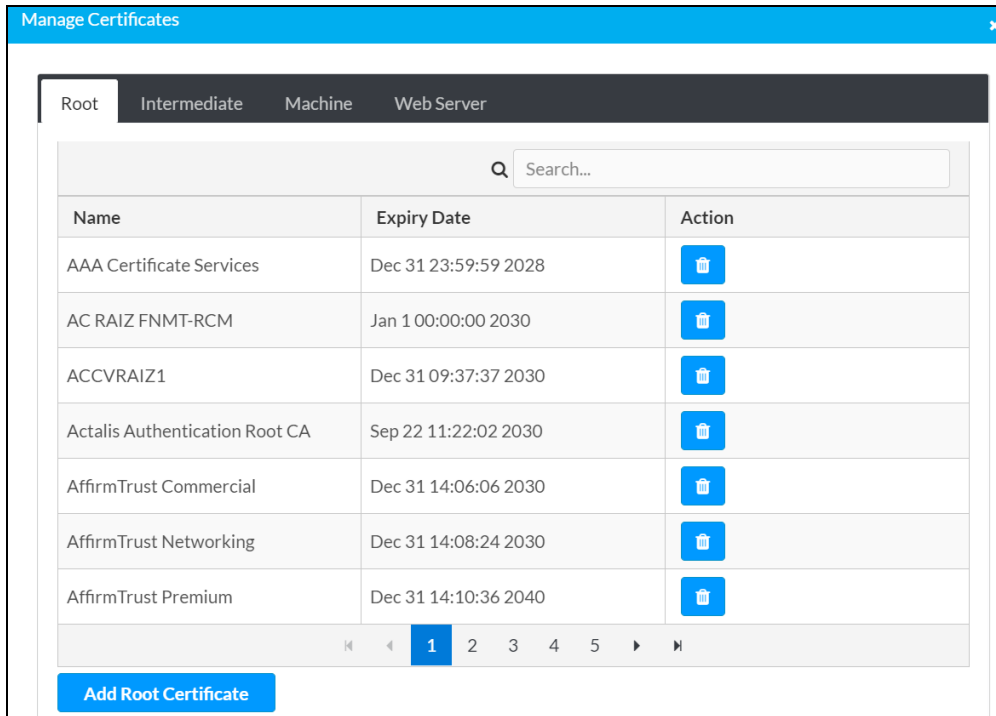

Select **Manage Certificates** in the **Action** drop-down menu. The following certificate tabs are displayed:

- **Root:** The Root certificate is used by the DM-NAX-8ZSA to validate the network's authentication server. The DM-NAX-8ZSA has a variety of Root certificates, self-signed by trusted CAs (Certificate Authorities) preloaded into the device. Root certificates must be self-signed.
- **Intermediate:** The Intermediate store holds non self-signed certificates that are used to validate the authentication server. These certificates will be provided by the network administrator if the network does not use self-signed Root certificates.
- **Machine:** The machine certificate is an encrypted PFX file that is used by the authentication server to validate the identity of the DM-NAX-8ZSA. The machine certificate will be provided by the network administrator, along with the certificate password. For 802.1x, only one machine certificate can reside on the device.
- **Web Server:** The Web Server certificate is a digital file that contains information about the identity of the web server.

To Add Certificates

1. Select the corresponding certificate tab.
2. Select **Add Root Certificate**.
3. Select **+ Browse**.
4. Locate and select the file, then select **Open**.

NOTE: If the certificate is a Machine Certificate, enter the password provided by the network administrator.

5. Select **OK**. This will add the certificate to the list box, displaying the file name and expiration date. The certificate is now available for selection and can be loaded to the device.

To Delete Certificates

1. Select the corresponding certificate tab.
2. Select the trashcan icon  in the **Actions** column to delete the certificate.
3. Select **Yes** when prompted to delete the certificate or **No** to cancel the deletion.

Manage Audio Profiles

Use the **Manage Audio Profiles** dialog to add, remove, and manage the audio profiles of speakers.

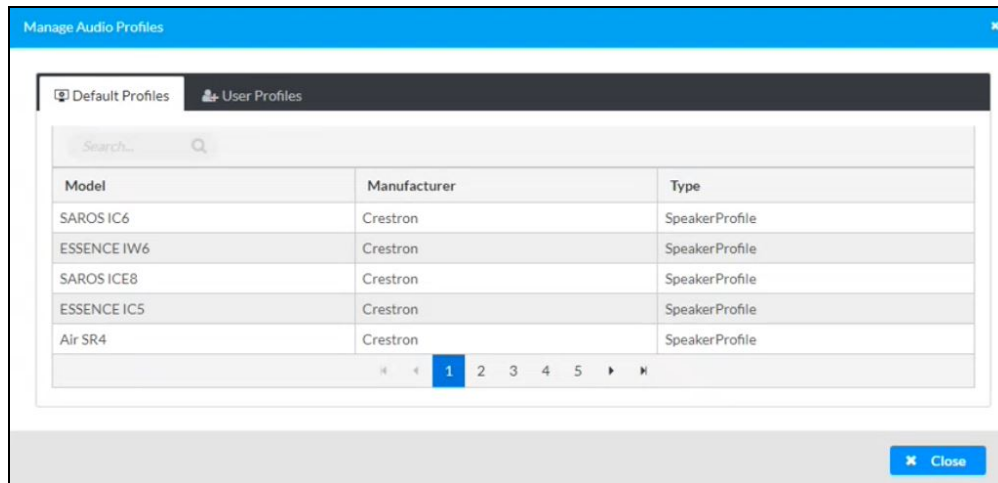

Select **Manage Audio Profiles** in the **Action** drop-down menu. The following audio profiles tabs are displayed, providing information such as **Model**, **Manufacturer**, and **Type** of the speaker profiles:

- **Default Profiles:** Lists the default library of included speaker profiles.
- **User Profiles:** Lists the custom, user loaded profiles, and allows them to be loaded and removed.

In the **Search** field, enter the speaker's profile name to search for the profile. The speaker profile matching the search criteria is displayed.

NOTE: To create a custom speaker profile, see [Online Help Article 1001820](#).

To Add a Speaker Profile

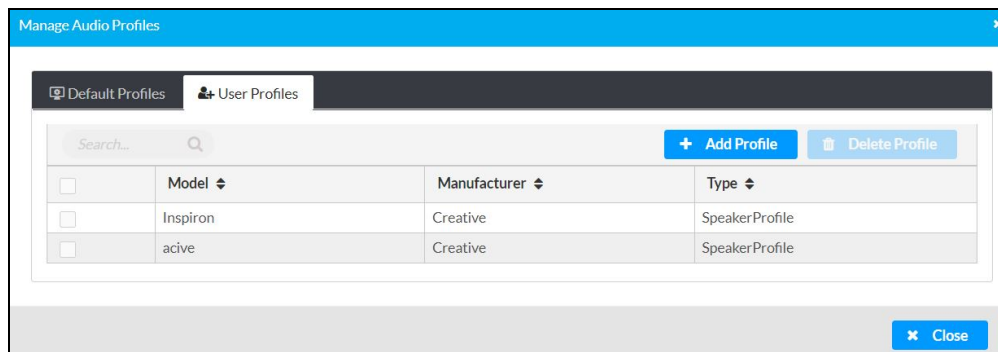

1. Select the **User Profiles** tab.
2. Select **+ Add Profiles**.
3. Select **+ Browse**.
4. Locate and select the .prof file, and then select **Open**.
5. Select **Upload**.

6. Select **OK**. This will add the profile to the list box.

The speaker profile is now available for selection and can be applied to the speaker.

To Delete a Speaker Profile

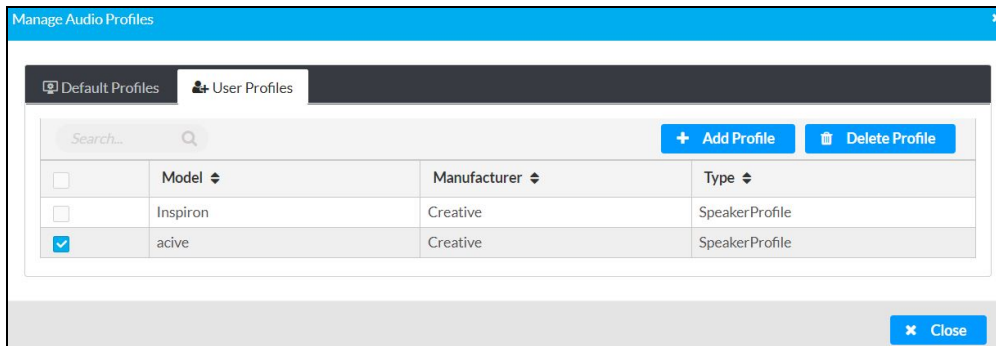

1. Select the **User Profiles** tab.
2. Select the checkbox corresponding to the audio profile that needs to be deleted.
3. Select **Delete Profile**.

The speaker profile is deleted.

Download Configuration

Select **Download Configuration** to download a TGZ file containing the settings data for the DM NAX device.

NOTE: User accounts for accessing the device, streaming service accounts, multicast addresses, and stream names are not saved in this configuration file.

Upload Configuration

1. Select **Upload Configuration** to upload a TGZ file that will overwrite the current settings of the DM NAX device with a saved configuration.

CAUTION: Be sure to load a TGZ file for the same DM NAX device type while using the Load Configuration feature. For example, if loading a TGZ file to a DM-NAX-8ZSA, be sure that the TGZ file originated from a DM-NAX-8ZSA.

2. Select **Browse** to navigate to the desired TGZ file in your file browser. Select the file, then select **Open**.

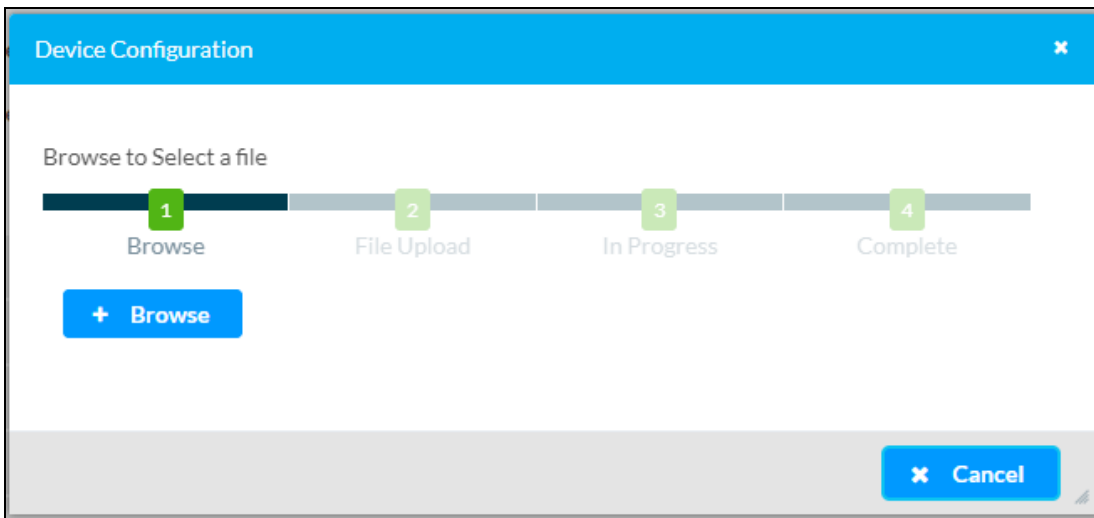

3. Select **Upload** to begin the file upload process. A progress bar will indicate the status of the configuration file upload.

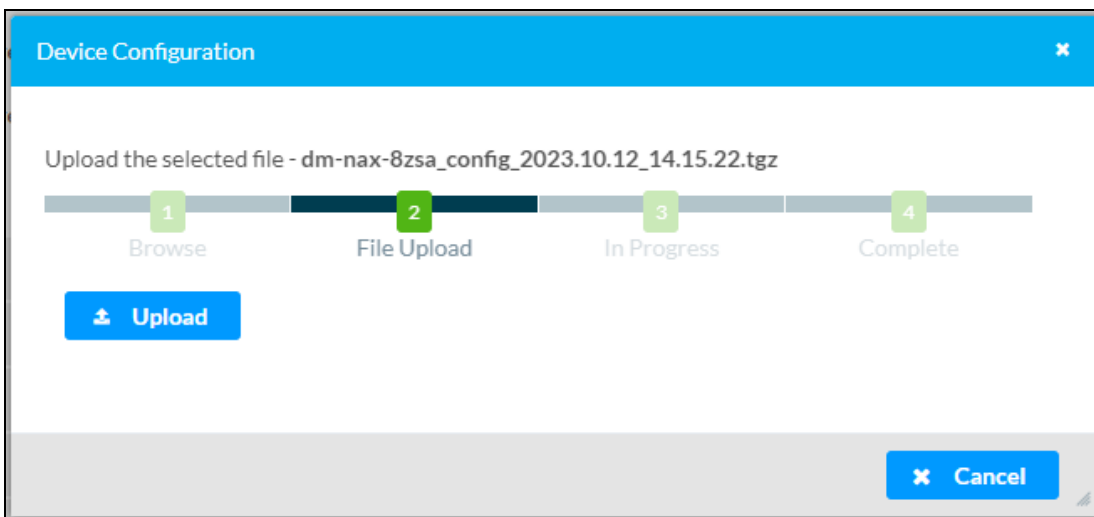

- Once the upload is complete, the device will require a reboot. Select **Yes, Reboot Now** to begin the reboot, or select **No** to return to the web UI.

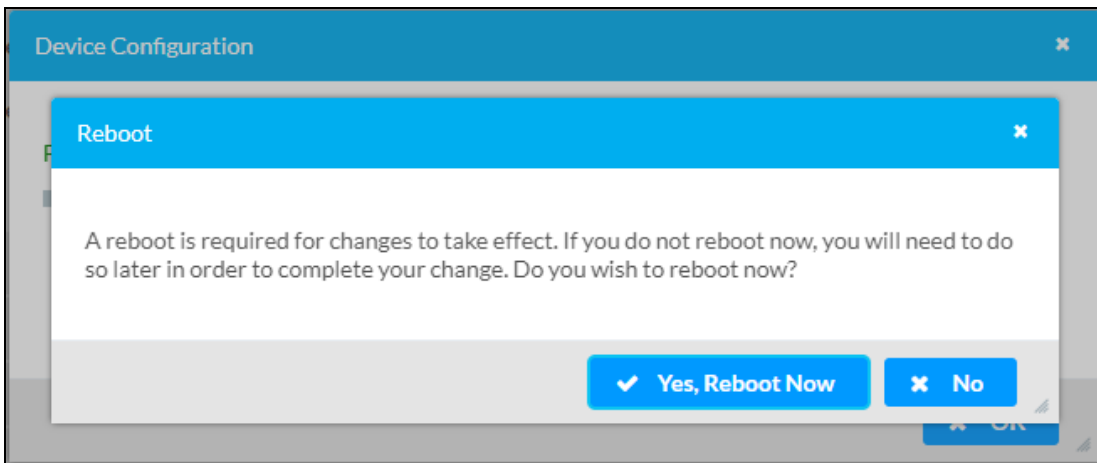

NOTE: Any changes made after the configuration file upload, but before a device reboot, may be overwritten when the device is rebooted.

Status

The **Status** page is the first page displayed when opening the interface of the DM-NAX-8ZSA. It displays general information about the DM-NAX-8ZSA (such as **Model Name**, **Firmware Version**, and **Serial Number**), current network settings (such as **Host Name** and **IP Address**, etc.), and input and output ports' current status.

The **Status** page can be accessed at any time by selecting the **Status** tab of the DM-NAX-8ZSA interface.

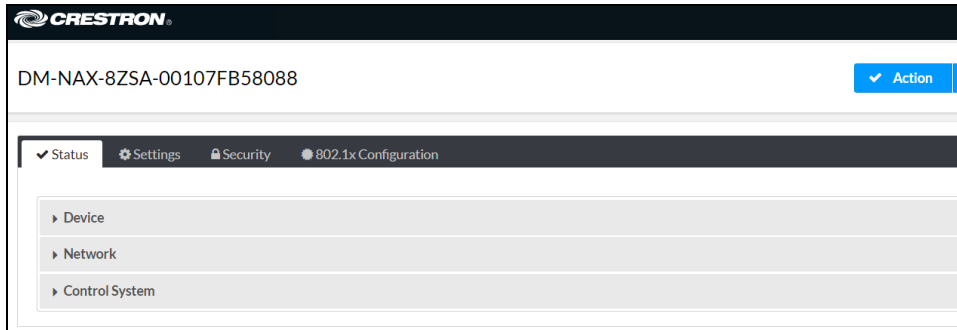

Information displayed on the **Status** tab is organized into different sections.

Device

The **Device** section displays the **Model**, **Firmware Version**, and **Serial Number** of the DM-NAX-8ZSA.

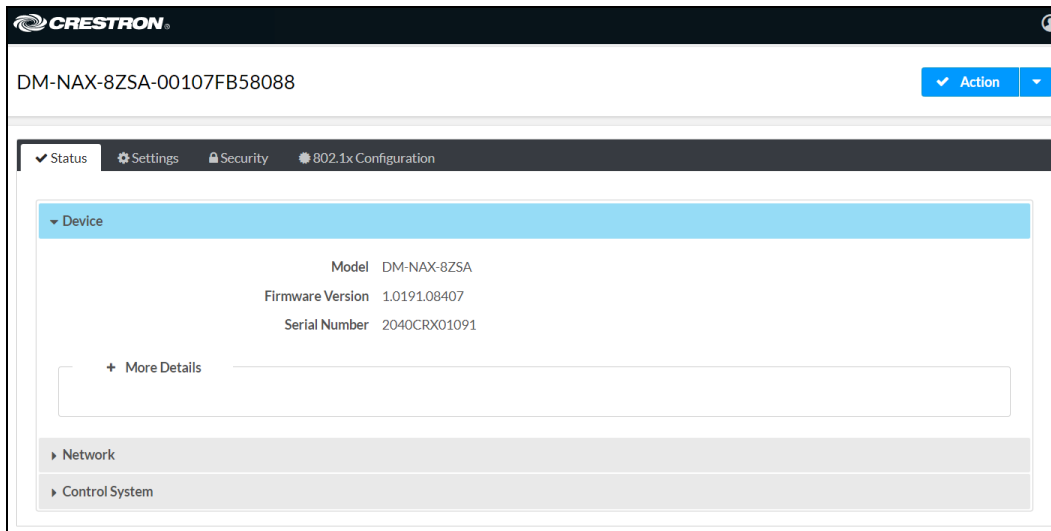

Select **+ More Details** to review additional information about the DM-NAX-8ZSA.

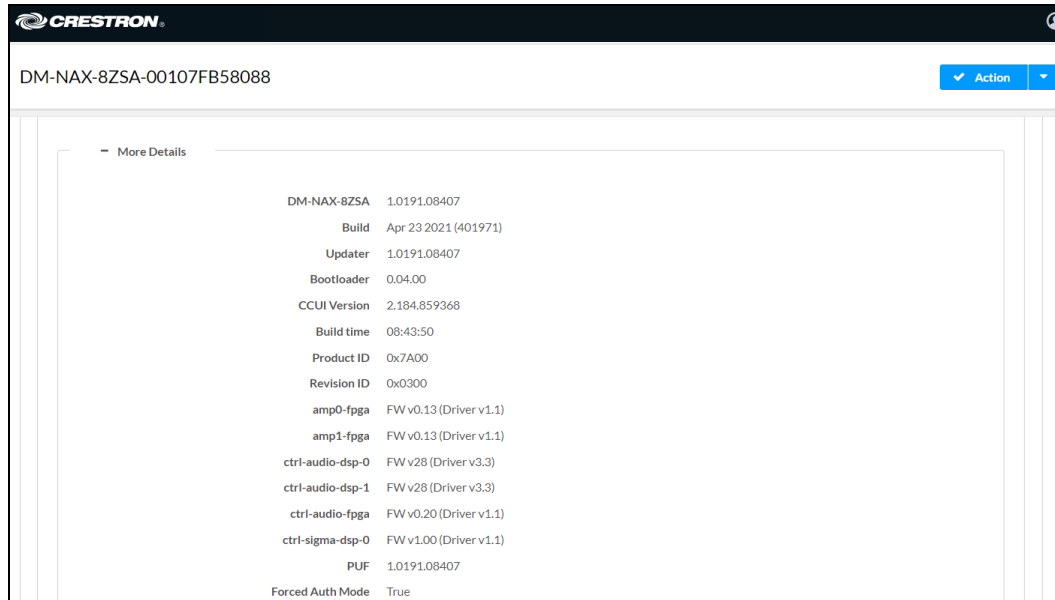

Network

The **Network** section displays network-related information about the DM-NAX-8ZSA, including the Hostname, Domain Name, and DNS Servers.

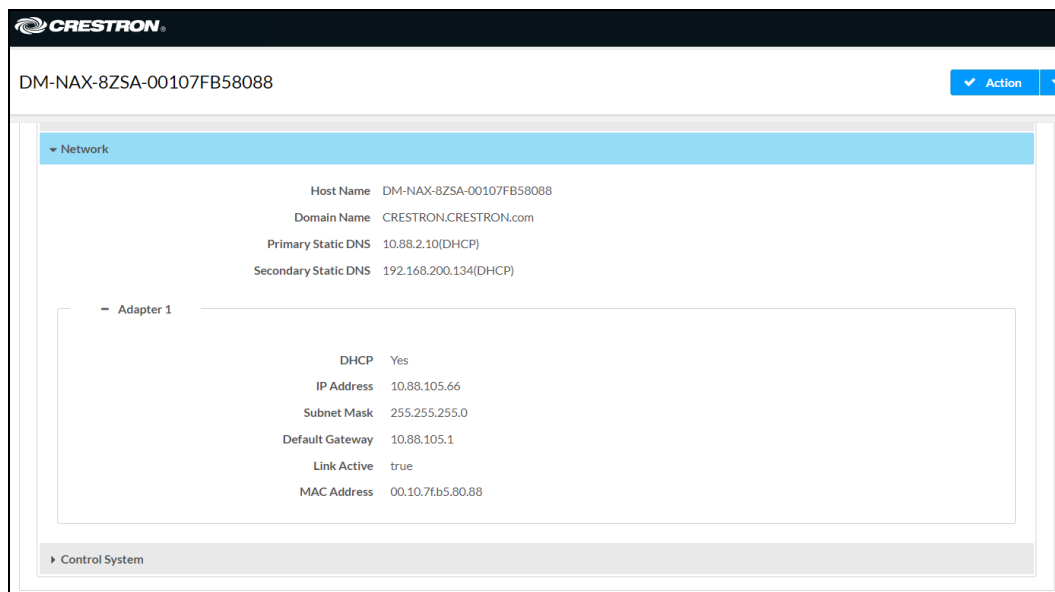

NOTE: By default, the host name of the DM-NAX-8ZSA consists of the model name followed by the MAC address of the device. For example, DM-NAX-8ZSA-00107FB58088.

Select **+ Adapter 1** to display an expanded section that shows additional information. If **+ Adapter 1** is selected, select **- Adapter 1** to collapse the section.

NOTE: The + **Adapter 2** option appears when the dual Ethernet ports on the DM-NAX-8ZSA are set to isolate traffic using the **Port Selection** feature. Refer to [Settings on page 204](#) for details on configuring the **Port Selection** feature.

Control System

The **Control System** section displays connection information, consisting of the following:

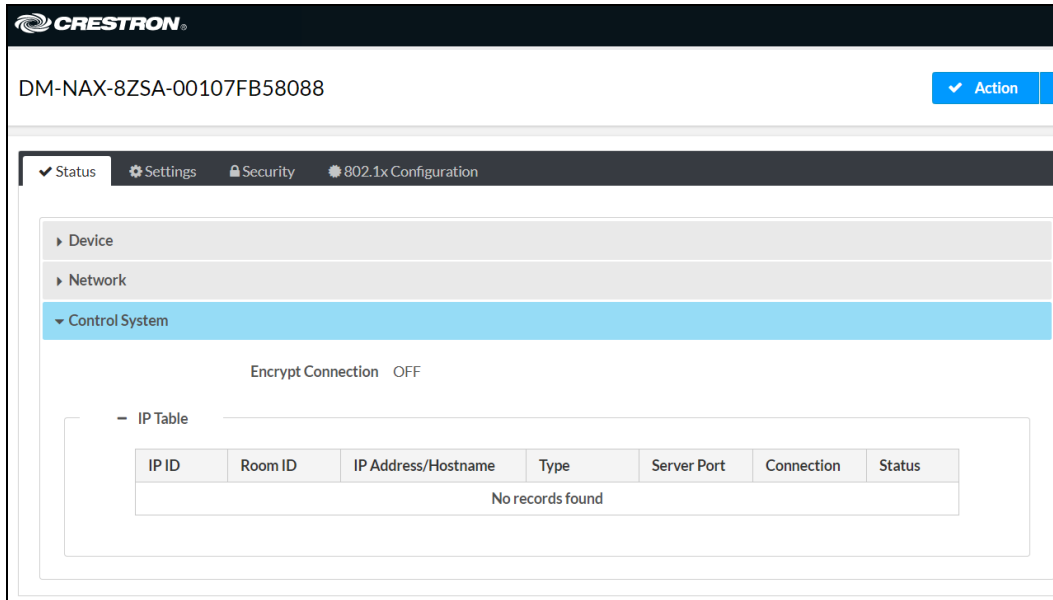

- **Encrypt Connection:** ON or OFF
- **IP ID:** Reports the currently used IP ID of the DM-NAX-8ZSA
- **IP Address/Hostname:** The IP address of the control system
- **Room ID:** Displays the room ID
- **Status:** OFFLINE or ONLINE

Settings

The **Settings** page enables you to configure the DM-NAX-8ZSA settings. The **Settings** page can be accessed at any time by selecting the **Settings** tab of the DM-NAX-8ZSA interface.

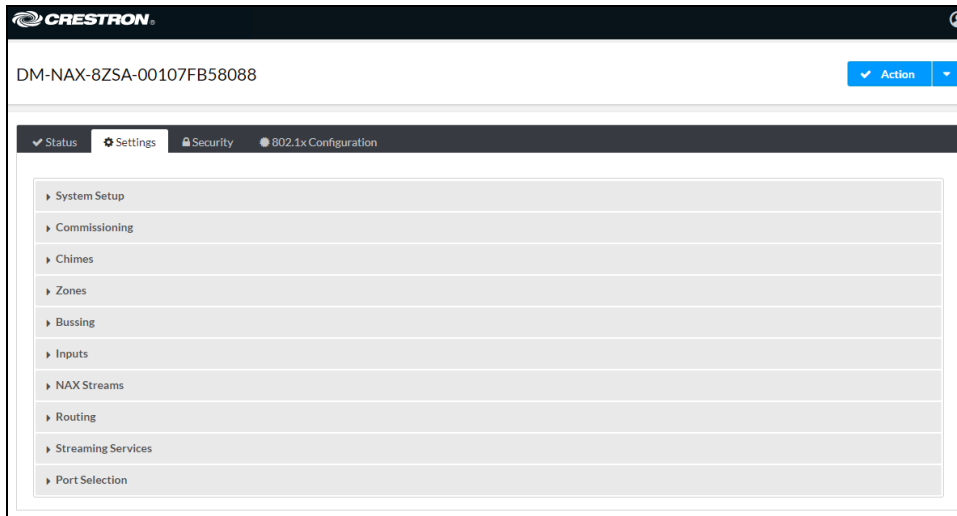

Settings available on the **Settings** tab are organized into different sections.

System Setup

The **System Setup** section contains settings for **Date/Time**, **Auto Update**, **Network**, and **Control System**.

Date/Time

Use the **Date/Time** section to configure the date and time settings of the DM-NAX-8ZSA.

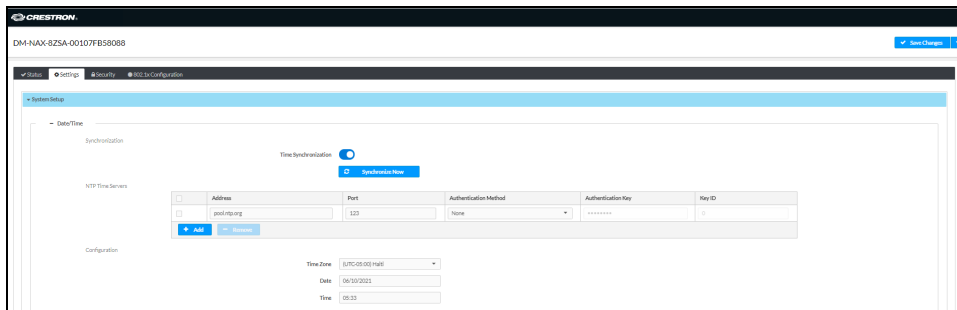

Time Synchronization

1. Set the **Time Synchronization** toggle to the right position to enable or left position to disable time synchronization. By default, time synchronization is enabled.
2. In the **NTP Time Servers** table, enter the URL of a NTP (Network Time Protocol) or SNTP (Simple Network Time Protocol) server. Up to three time servers can be added on a device.
3. Select **Synchronize Now** to perform time synchronization between the device's internal clock and the time server.

Time Configuration

1. Open the **Time Zone** drop-down menu to select the applicable time zone.
2. In the **Date** field, enter the current date.
3. In the **Time (24hr Format)** field, enter the current time in 24-hour format.

Select **Save Changes** to save the settings.

Select **Revert** from the **Action** drop-down menu to revert to the previous settings without saving.

Auto Update

The DM-NAX-8ZSA can automatically check for and install firmware updates at scheduled intervals via the Auto Update feature.

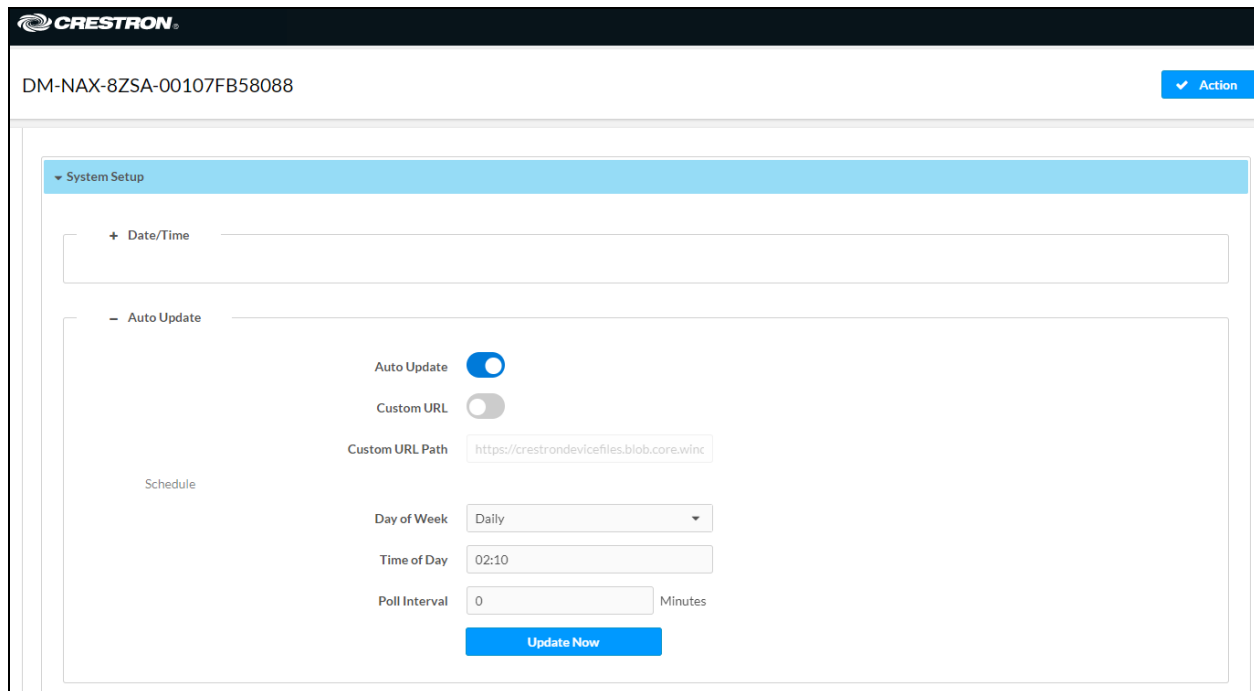

The screenshot shows the Crestron web interface for device DM-NAX-8ZSA-00107FB58088. The 'System Setup' section is expanded to show the 'Auto Update' configuration. The 'Auto Update' toggle is turned on. The 'Custom URL' toggle is turned off. The 'Custom URL Path' is set to 'https://crestrondevicefiles.blob.core.winc'. The 'Schedule' section includes a 'Day of Week' dropdown set to 'Daily', a 'Time of Day' input field set to '02:10', and a 'Poll Interval' input field set to '0' minutes. An 'Update Now' button is visible at the bottom of the configuration area.

1. Set the **Auto Update** toggle to the right position to enable Auto Update.
2. Define the URL to download the updates by doing either of the following:
 - a. Use the default URL to download the updates from the Crestron server.
 - b. Use a custom URL. Set the **Custom URL** toggle to the right position to enable a custom URL. In the **Custom URL Path** text box, enter the path to a custom manifest file in the FTP or SFTP URL format. Use the Crestron Auto Update Tool to generate a custom manifest file, then store the file on an FTP (File Transfer Protocol) or SFTP (Secure File Transfer Protocol) server.
3. Set a schedule for the automatic firmware update by doing either of the following:
 - a. Select the desired **Day of Week** and **Time of Day** (24-hour format) values.
 - b. Set the **Poll Interval** by entering a value from **60** to **65535** minutes. A value of **0** disables the Poll Interval.
4. Select **Save Changes**.

Selecting **Update Now** causes the device to check for a firmware update immediately. If a schedule was set in step 4 above, that schedule still remains in effect.

Network

The **Network** section contains network-related settings for the DM-NAX-8ZSA, including the Hostname, Domain, Primary Static DNS, and Secondary Static DNS.

The screenshot shows the network configuration page for a Crestron device. At the top, the device ID is DM-NAX-8ZSA-00107FB58088. Below this, there are two main sections: 'Auto Update' and 'Network'. The 'Network' section is expanded and contains the following fields:

- Host Name: DM-NAX-8ZSA-00107FB58088
- Domain: CRESTRON.CRESTRON.com
- Primary Static DNS: 10.88.2.10(DHCP)
- Secondary Static DNS: 192.168.200.134(DHCP)
- Adapter 1: A subheading for the first network adapter.
- DHCP: A toggle switch that is currently turned on (right).
- IP Address: 10.88.105.66
- Subnet Mask: 255.255.255.0
- Default Gateway: 10.88.105.1

NOTE: By default, the hostname of the DM-NAX-8ZSA consists of the model name followed by the MAC address of the device. For example, DM-NAX-8ZSA-00107FB58088.

Adapter 1

The Adapter 1 subheading contains settings for DHCP, IP Address, Subnet Mask, and Default Gateway of Ethernet adapter 1 on the rear panel of the device.

NOTES:

- An **+ Adapter 2** option only appears when the dual Ethernet ports on the DM-NAX-8ZSA are set to isolate traffic using the Port Selection feature. The settings for Adapter 2 are identical to those available for Adapter 1.
- DM NAX devices' internal processes use IP addresses in the 10.10.10.xxx range. This IP range should be avoided when addressing DM NAX devices to prevent conflicts.

Set the **DHCP** toggle to enabled (right) or disabled (left) to specify whether the IP address of the DM-NAX-8ZSA is to be assigned by a DHCP (Dynamic Host Configuration Protocol) server.

- **Enabled:** When DHCP is enabled (default setting), the IP address of the DM-NAX-8ZSA is automatically assigned by a DHCP server on the local area network (LAN).
- **Disabled:** When DHCP is disabled, manually enter information in the following fields:
 - **Primary Static DNS:** Enter a primary DNS IP address.
 - **Secondary Static DNS:** Enter a secondary DNS IP address.
 - **IP Address:** Enter a unique IP address for the DM-NAX-8ZSA.

- **Subnet Mask:** Enter the subnet mask that is set on the network.
- **Default Gateway:** Enter the IP address that is to be used as the network's gateway.

To save any new network entries, select **Save Changes**.

Control System

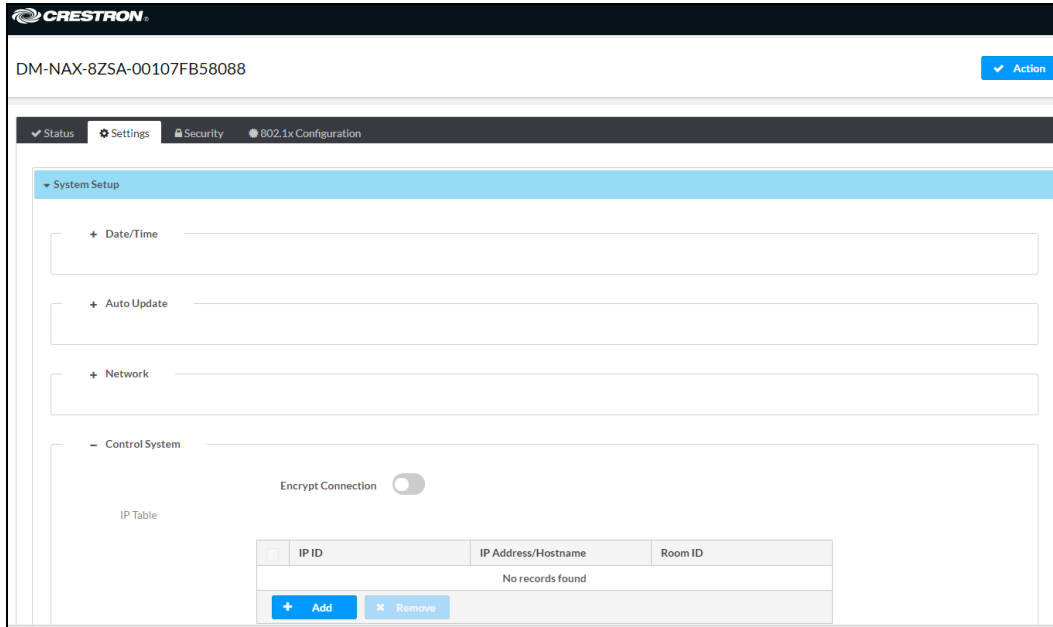

1. Select the **Encrypt Connection** toggle to the right to enable a secure connection between the control system and the DM-NAX-8ZSA. Set the toggle to the left to use an unencrypted connection to the control system. If the toggle is set to the right:
 - a. Enter the username in the **Control System Username** field.
 - b. Enter the password in the **Control System Password** field.
2. Select **+ Add** to add an IP table entry to the **IP Table**.
 - a. Enter the Room ID in the **Room ID** field.
 - b. Enter the IP ID of the DM-NAX-8ZSA in the **IP ID** field.
 - c. Enter the IP address or hostname of the control system in the **IP Address/Hostname** field.
3. Select **Save Changes** to save the new entries. The **Control System Save** message box appears, indicating that the control system settings were saved successfully. Select **Revert** to revert to the previous settings without saving.

Commissioning

The **Commissioning** section provides a quick way to automatically assign multicast addresses to all of the device's internal audio-over-IP stream transmitters.

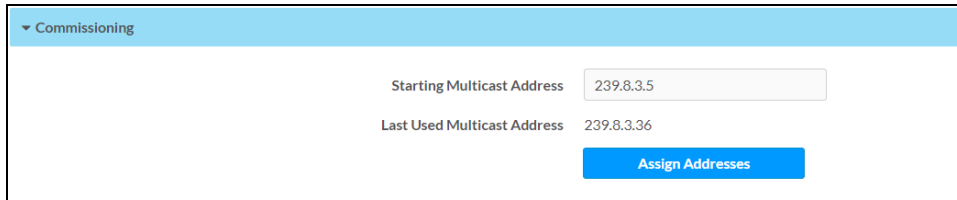

▼ Commissioning

Starting Multicast Address

Last Used Multicast Address 239.8.3.36

[Assign Addresses](#)

Select **Assign Addresses** to give each DM NAX transmitter in the DM-NAX-8ZSA a unique multicast address beginning with the specified **Starting Multicast Address**. The valid range for **Starting Multicast Address** is 239.8.0.0 to 239.255.255.231.

NOTE: This will begin transmitting multicast traffic on your network. Refer to [Audio-over-IP Network Design on page 632](#) for details on proper audio-over-IP network management.

Chimes

The **Chimes** section allows the built-in chime files to be assigned to any of the output zones on the device.

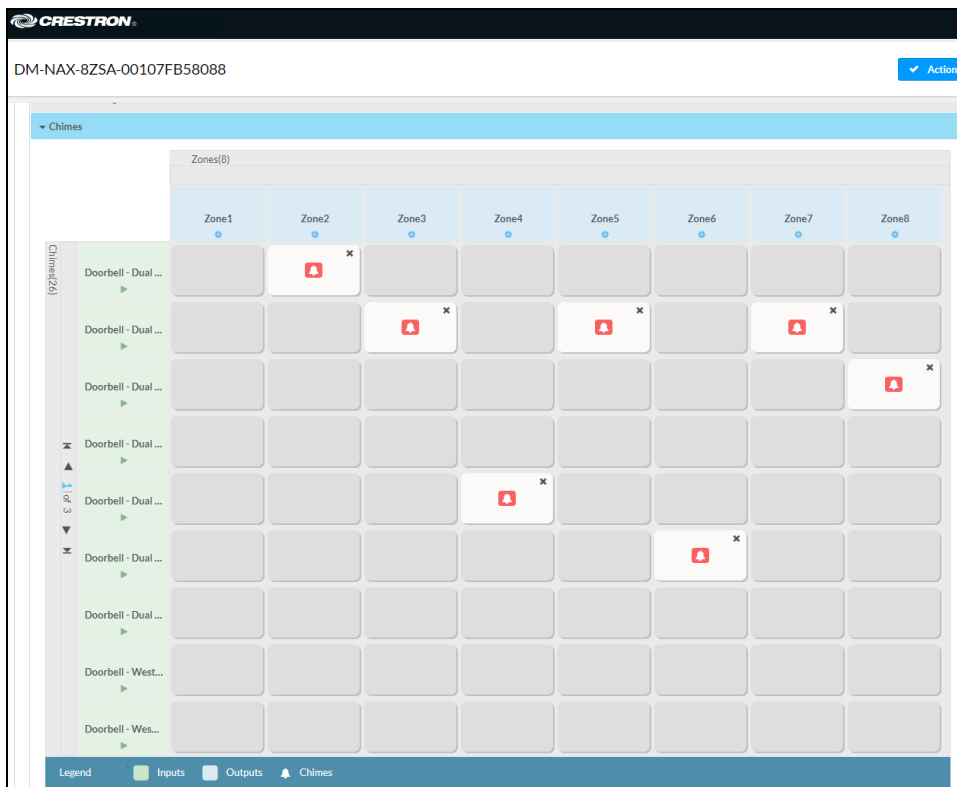

DM-NAX-8ZSA-00107FB58088 [Action](#)

▼ Chimes

	Zone1	Zone2	Zone3	Zone4	Zone5	Zone6	Zone7	Zone8
Doorbell - Dual...		Chime						
Doorbell - Dual...			Chime		Chime		Chime	
Doorbell - Dual...								Chime
Doorbell - Dual...				Chime				
Doorbell - Dual...						Chime		
Doorbell - Dual...								
Doorbell - West...								
Doorbell - Wes...								

Legend: ■ Inputs ■ Outputs ▲ Chimes

For each chime file, select the cells corresponding to the desired Zones for playback of that specific chime sound. You can assign multiple chimes to the same zone. To view all available chimes, use the ▲ or ▼ arrows at the left of the matrix to change pages.

To configure the chime volume of a zone:

1. Select the  icon corresponding to the zone. A **Configure** window appears.

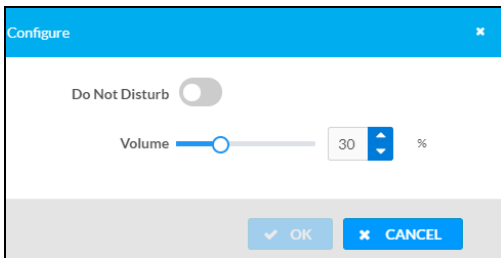

2. To set the volume, do one of the following:

- Move the **Volume** slider to the right to increase or to the left to decrease the chime volume.
- Use the **%** arrows to increase or decrease the chime volume. Values range from 0 to 100%, adjustable in increments of 1%.
- Manually enter a value in the **Volume** field.

NOTE: The chime volume is independent of the zone volume control.

3. Set the **Do Not Disturb** toggle to the right to mute all chimes for the zone. Set the **Do Not Disturb** toggle to the left to unmute the chimes.
4. Select **OK** to apply the new settings.

Zones

The **Zones** section contains the **Volume** and **Mute** settings for all zone outputs of the device, as well as a Configure option for more advanced settings within each zone.

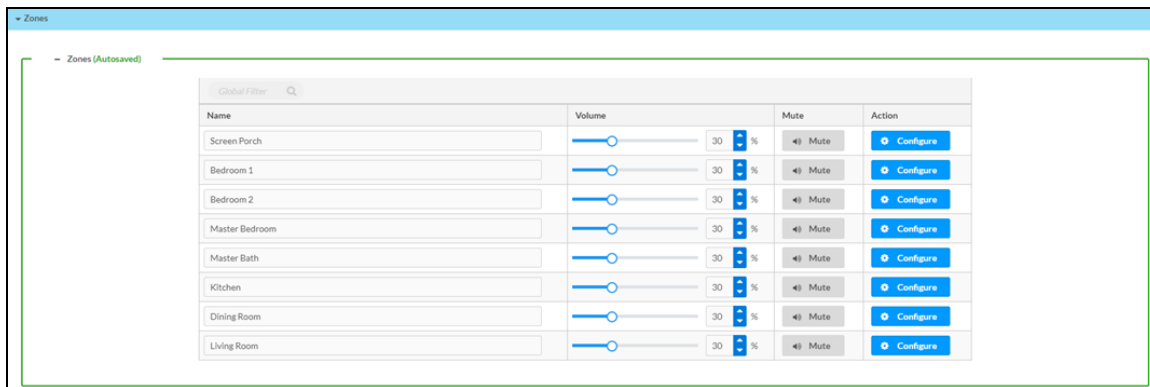

Name	Volume	Mute	Action
Screen Porch	<input type="range"/> 30 %	<input type="checkbox"/> Mute	<input type="button" value="Configure"/>
Bedroom 1	<input type="range"/> 30 %	<input type="checkbox"/> Mute	<input type="button" value="Configure"/>
Bedroom 2	<input type="range"/> 30 %	<input type="checkbox"/> Mute	<input type="button" value="Configure"/>
Master Bedroom	<input type="range"/> 30 %	<input type="checkbox"/> Mute	<input type="button" value="Configure"/>
Master Bath	<input type="range"/> 30 %	<input type="checkbox"/> Mute	<input type="button" value="Configure"/>
Kitchen	<input type="range"/> 30 %	<input type="checkbox"/> Mute	<input type="button" value="Configure"/>
Dining Room	<input type="range"/> 30 %	<input type="checkbox"/> Mute	<input type="button" value="Configure"/>
Living Room	<input type="range"/> 30 %	<input type="checkbox"/> Mute	<input type="button" value="Configure"/>

Give each zone a friendly name using the **Name** column of the **Zones** table. If the device is paired with a control system, these names may be overwritten by the control system's program.

To configure the zone volume, do one of the following:

- Move the **Volume** slider to the right to increase or to the left to decrease the zone volume.
- Use the **%** arrows to increase or decrease the zone volume. Values range from 0 to 100%, adjustable in increments of 1%.
- Manually enter a value in the **Volume** field.

To mute all audio output from a zone, select its respective **Mute**. To unmute the zone, select **Muted**.

Zone Settings

To configure zone settings, select **Configure** . The **Edit Zone** window appears.

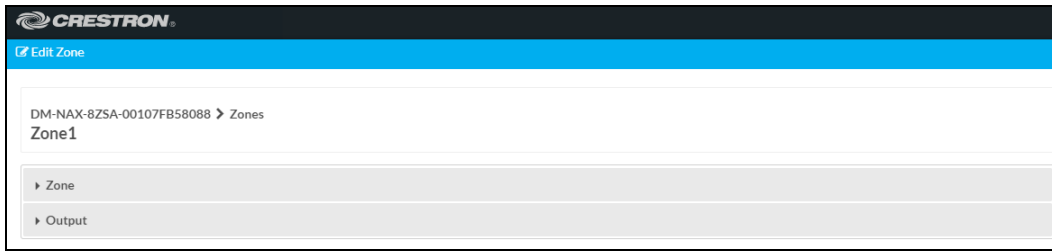

Zone

Select **Zone** to access the settings for **Tone**, **Balance**, and **Delay**.

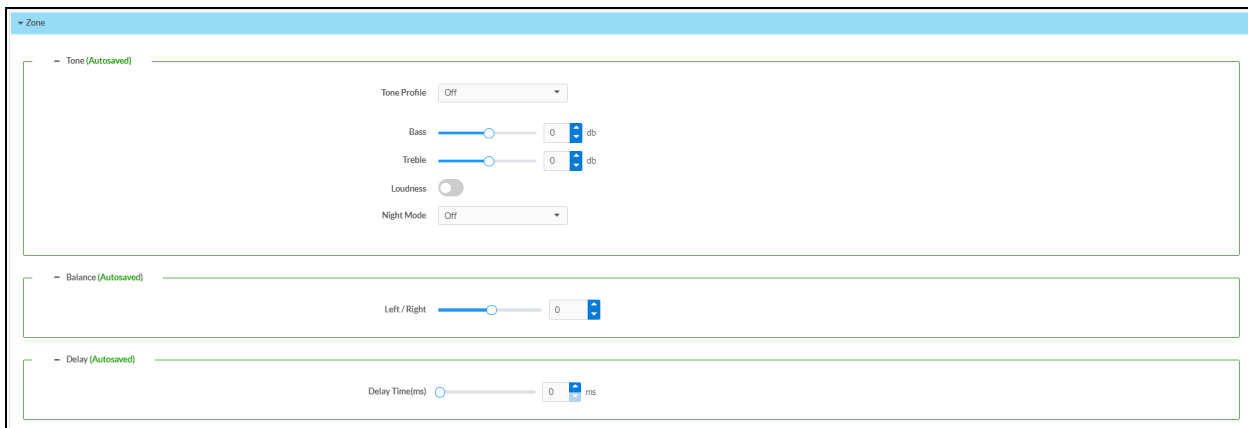

Tone

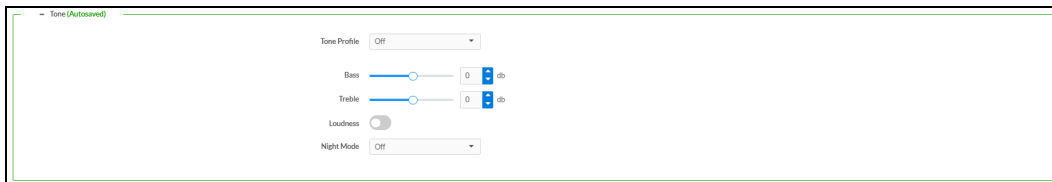

The **Tone** section provides adjustments for the **Tone Profile**, **Bass**, **Treble**, **Loudness**, and **Night Mode** settings of the zone output.

NOTE: The Tone Profile, Bass, Treble, and Loudness settings in the Tone section are all applied separately from the Equalizer Settings for the zone. This means that any adjustments made in the Tone section will stack with those made in the Equalizer Settings section.

1. To select a tone profile preset for the zone, select an option from the **Tone Profile** drop-down menu. The available options are **Off**, **Classical**, **Jazz**, **Pop**, **Rock**, and **Spoken Word**. By default, **Off** is selected.

2. **Bass:** To adjust the bass, do one of the following:
 - Move the **Bass** slider to the right to increase or to the left to decrease the bass.
 - Use the **db** arrows to increase or decrease the bass level. Values range from -12 dB to 12 dB, adjustable in increments of 1 dB.
 - Manually enter a value in the **Bass** field.
3. **Treble:** To adjust the treble, do one of the following:
 - Move the **Treble** slider to the right to increase or to the left to decrease the treble.
 - Use the **db** arrows to increase or decrease the treble level. Values range from -12 dB to 12 dB, adjustable in increments of 1 dB.
 - Manually enter a value in the **Treble** field.
4. To enable the loudness setting on the zone output, slide the **Loudness** switch to the right. To disable loudness, slide the **Loudness** switch to the left.
5. The **Night Mode** feature applies subtle processing to restrict the dynamic range of the zone audio, to allow for lower listening levels at night or in rooms where higher listening levels would be disruptive. To select a dynamics processing level, select an option from the **Night Mode** drop-down menu. The available options are **Off**, **Low**, **Medium**, and **High**. By default, **Off** is selected.

Balance

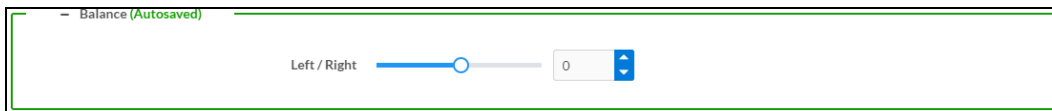

To adjust the left/right balance of the stereo output signal, do one of the following:

- Move the **Balance** slider to the right to shift the stereo balance to the right channel or to the left to shift the balance to the left.
- Use the arrows to adjust the balance left or right. The up arrow shifts the balance to the right while the down arrow shifts the balance to the left.
- Manually enter a value in the **Balance** field. Values range from -50 to 50, adjustable in increments of 1. Positive values shift the balance to the right while negative values shift the balance to the left.

Delay

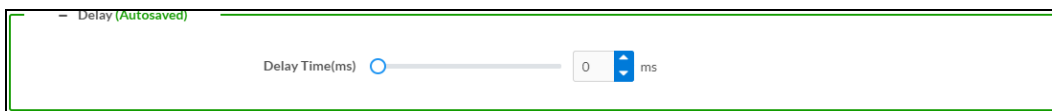

To set the delay, do one of the following:

- Move the **Delay Time(ms)** slider to the right to increase or to the left to decrease the delay time.
- Use the **ms** arrows to increase or decrease the delay. Values range from 0 ms to 250 ms, adjustable in increments of 1 ms.
- Manually enter a value in the **Delay Time(ms)** field.

Output

Select **Output** to access the settings for **Minimum/Maximum Volume**, **Stereo/Mono**, **Signal**, **Bussing Volume Offset**, **Configure Speaker Profile**, **Speaker Configuration**, **Casting**, **Speaker/Faults**, **Line Out**, **Signal Generator**, **Advanced Signal Generator**, and **Equalizer Settings**.

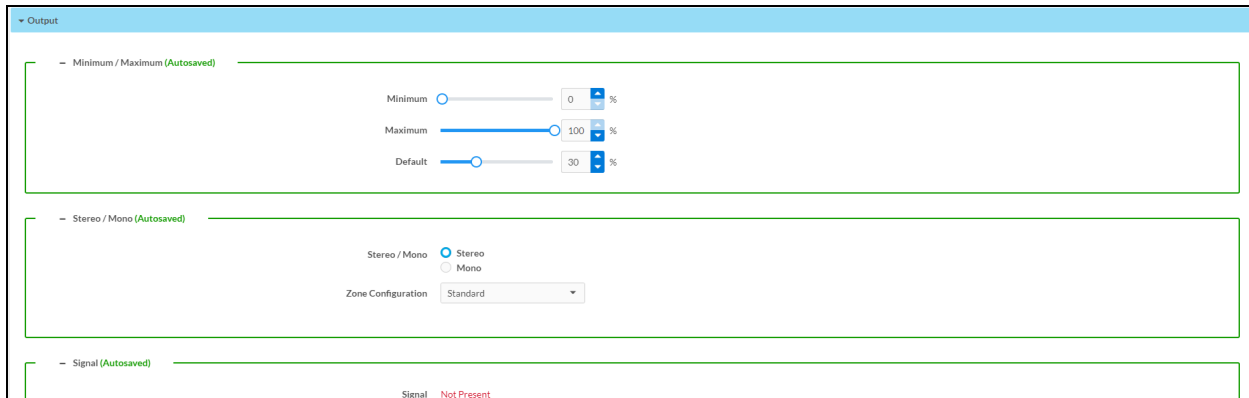

Minimum/Maximum Volume

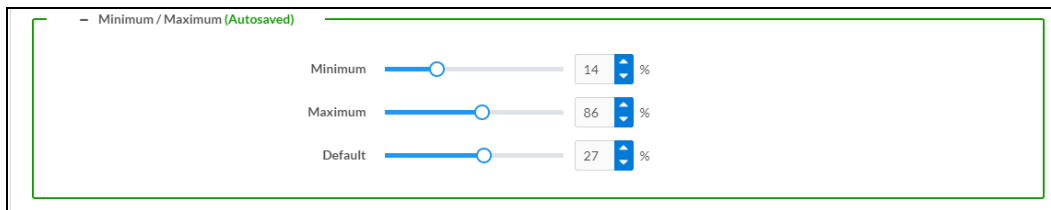

1. To set the minimum volume of the zone, do one of the following:
 - Move the **Minimum** slider to the right to increase or to the left to decrease the minimum volume.
 - Use the **%** arrows to increase or decrease the minimum volume. Values range from 0 to 50%, adjustable in increments of 1%.
 - Manually enter a value in the **Minimum** field.
2. To set the maximum volume of the zone, do one of the following:
 - Move the **Maximum** slider to the right to increase or to the left to decrease the maximum volume.
 - Use the **%** arrows to increase or decrease the maximum volume. Values range from 70 to 100%, adjustable in increments of 1%.
 - Manually enter a value in the **Maximum** field.

NOTE: When a **Minimum** and **Maximum** volume are set, the 1-100% range represented by the **Zone** and **Default** volume controls are scaled to the range set. For example, if a **Minimum** of 10% and a **Maximum** of 80% are set for a zone, the 1-100% range of the **Zone** volume control is scaled to the 10%-80% range set as the **Minimum** and **Maximum**.

3. To set the default volume of the zone, do one of the following:
- Move the **Default** slider to the right to increase or to the left to decrease the default volume.
 - Use the **%** arrows to increase or decrease the default volume. Values range from 0 to 50%, adjustable in increments of 1%.
 - Manually enter a value in the **Default** field.

NOTE: The **Default** volume is applied as the **Zone** volume any time the zone receives a source route and no source was previously routed to that zone.

Stereo/Mono

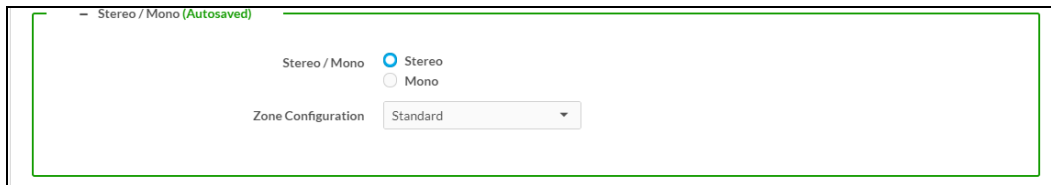

1. Select either **Stereo** or **Mono** from the **Stereo/Mono** field.
2. Select the zone configuration from the **Zone Configuration** drop-down menu. The available values are **Standard**, **Bridged**, **Bridged 2.1**, **Bridged Sub 2.1**, and **Bridged Mono**. See the diagrams below for the output signal flow applied in each configuration.

NOTE: The **Stereo/Mono** field is disabled for the Bridged 2.1, Bridged Sub 2.1, and Bridged Mono zone configurations.

Stereo - Standard

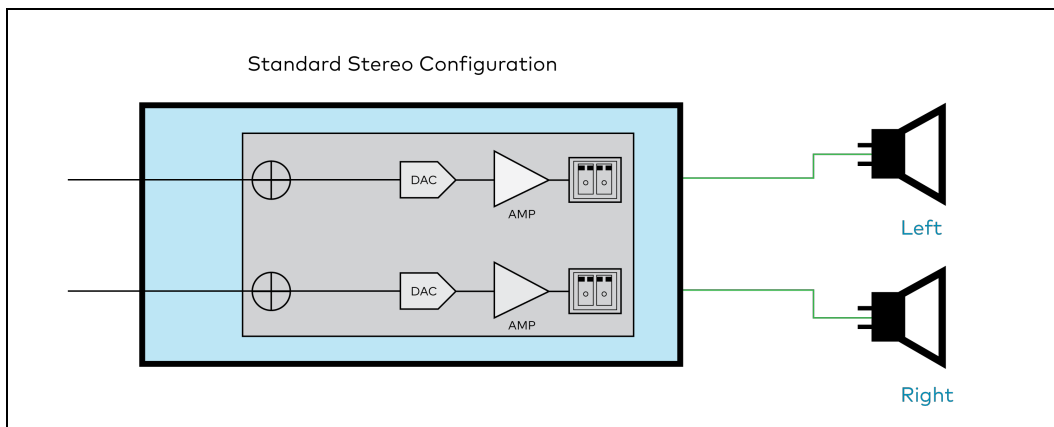

Stereo - Bridged

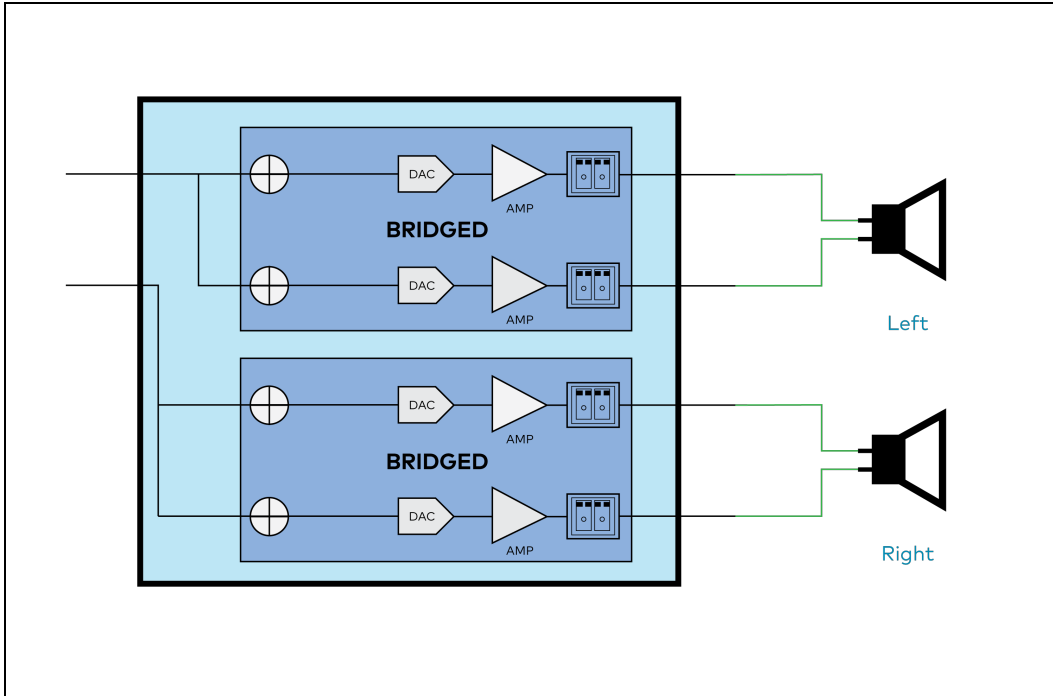

Mono - Standard

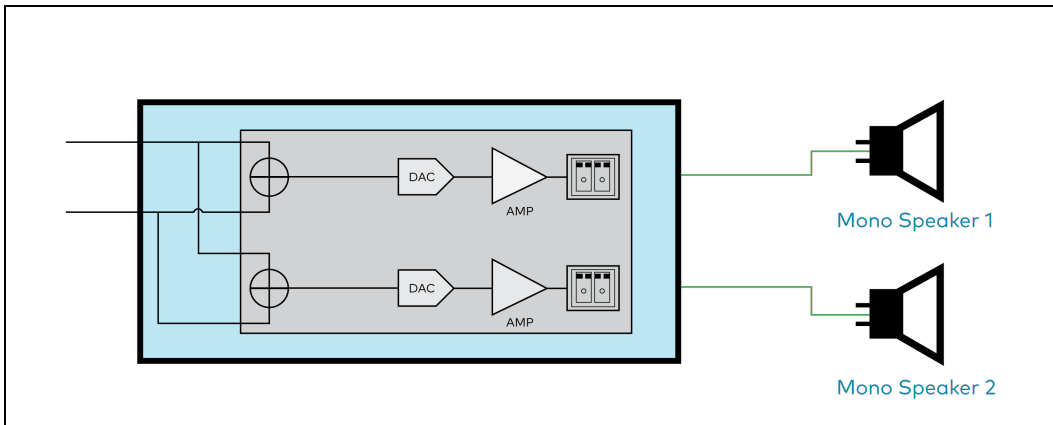

Mono - Bridged

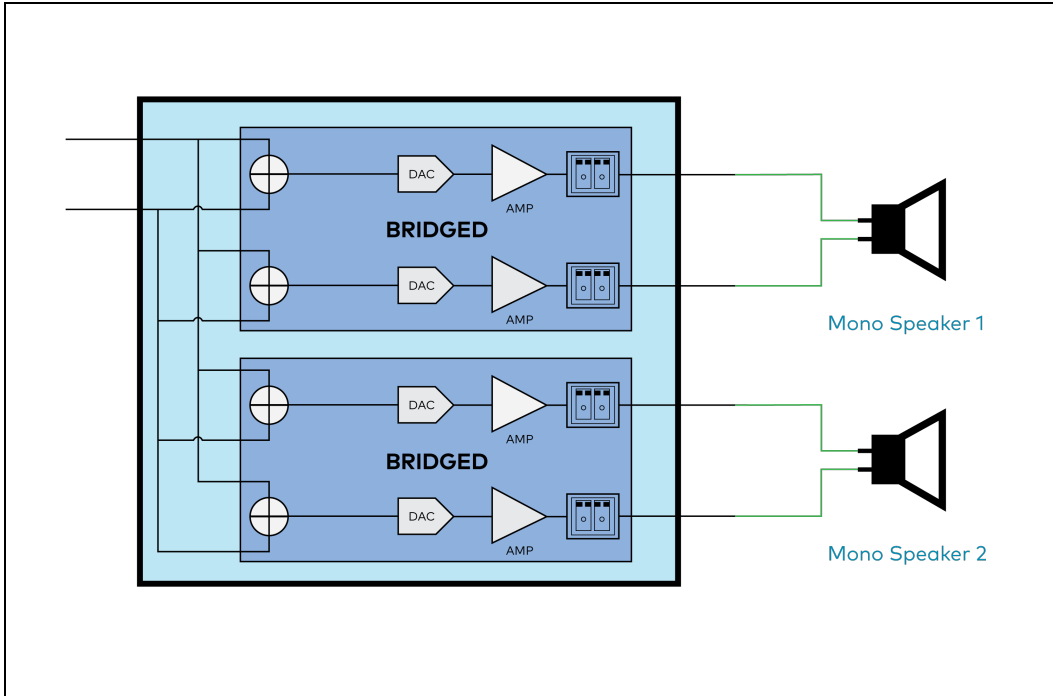

Bridged 2.1

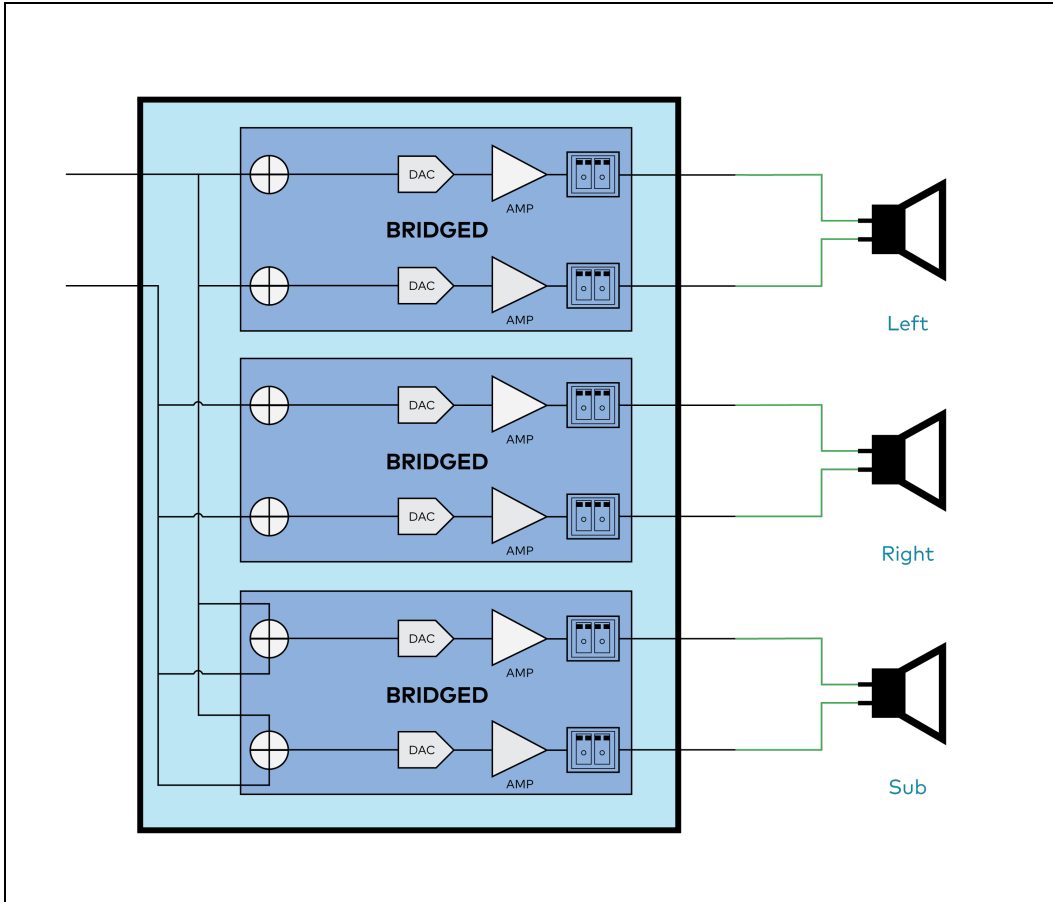

Bridged Sub 2.1

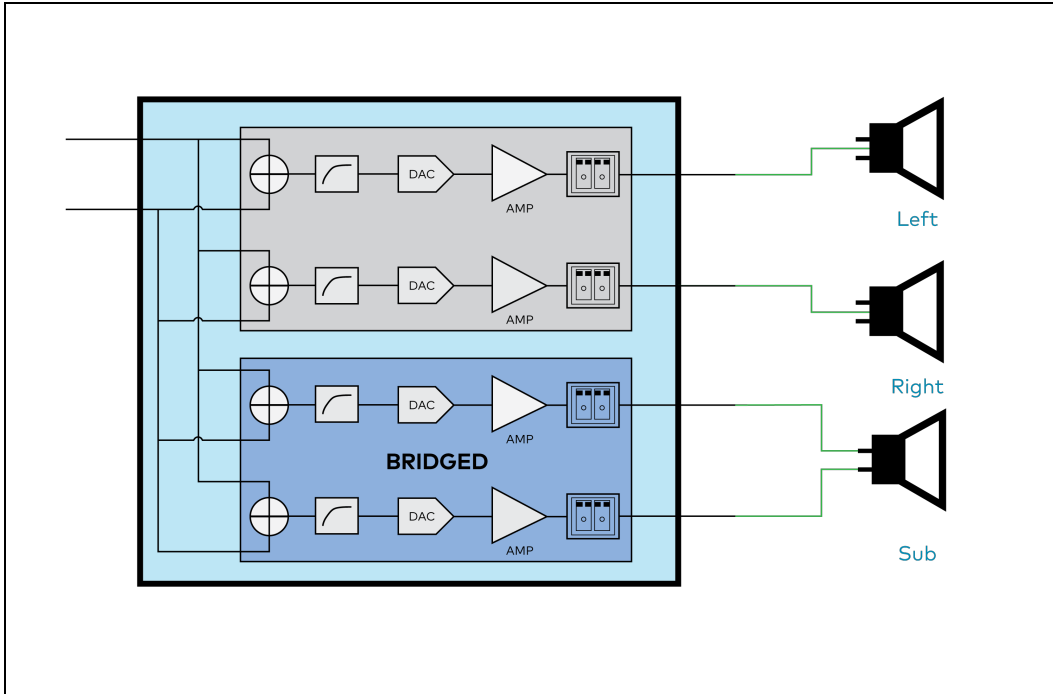

Bridged Mono

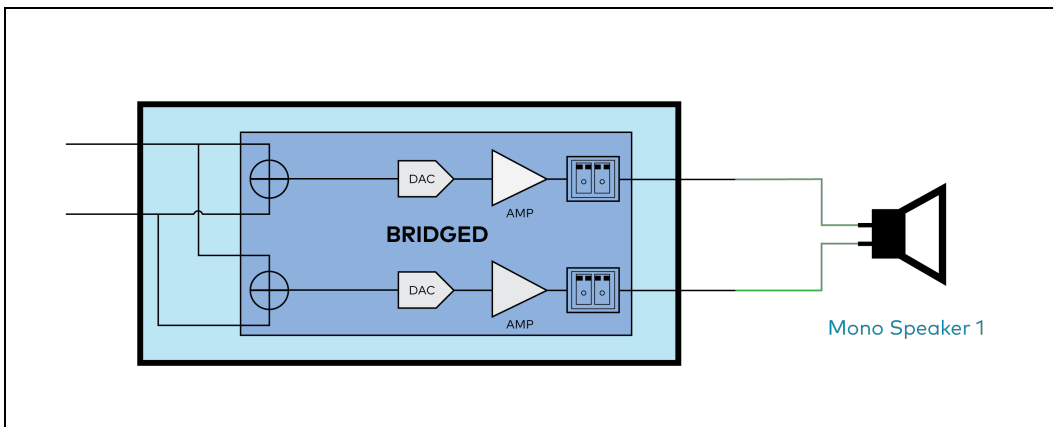

Signal

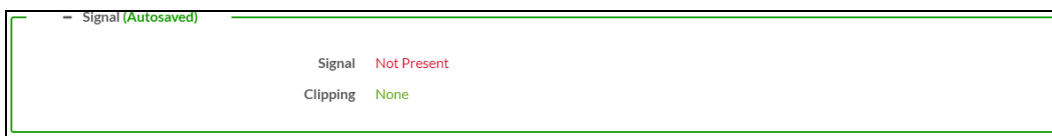

The **Signal** section is a read-only field that displays the **Signal** and **Clipping** status of the zone output.

- If an output signal is present but not clipping, **Signal** will display **Present** in green and **Clipping** will display **None** in green.
- If an output signal is present and clipping, **Signal** will display **Present** in green and **Clipping** will display **Present** in red.

- If no output signal is detected, **Signal** will display **Not Present** in red and **Clipping** will display **None** in green.

Bussing Volume Offset

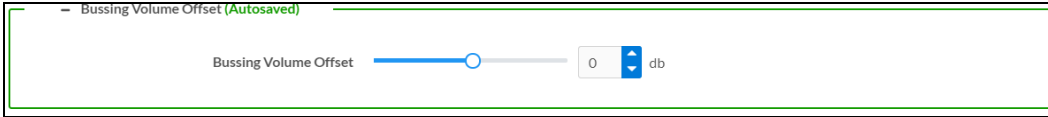

Bussing Volume Offset is an additional level compensation applied to the zone relative to any other zones it is grouped with via the **Bussing** feature.

To set the bussing volume offset, do one of the following:

- Move the **Bussing Volume Offset** slider to the right to increase or to the left to decrease the offset.
- Use the **db** arrows to increase or decrease the offset. Values range from -12 dB to 12 dB, adjustable in increments of 1 dB.
- Manually enter a value in the **Bussing Volume Offset** field.

Configure Speaker Profile

The DM-NAX-8ZSA has a library of built-in speaker profiles that contain equalizer, speaker protection, and impedance settings specific to Crestron and third-party speaker models. Custom speaker profiles can also be generated and loaded to the DM-NAX-8ZSA. The **Configure Speaker Profile** field is used to apply these speaker profiles to a given zone of the DM NAX device.

NOTE: Applying a speaker profile on a zone will overwrite the existing **Speaker Configuration** and **Equalizer** settings for that zone.

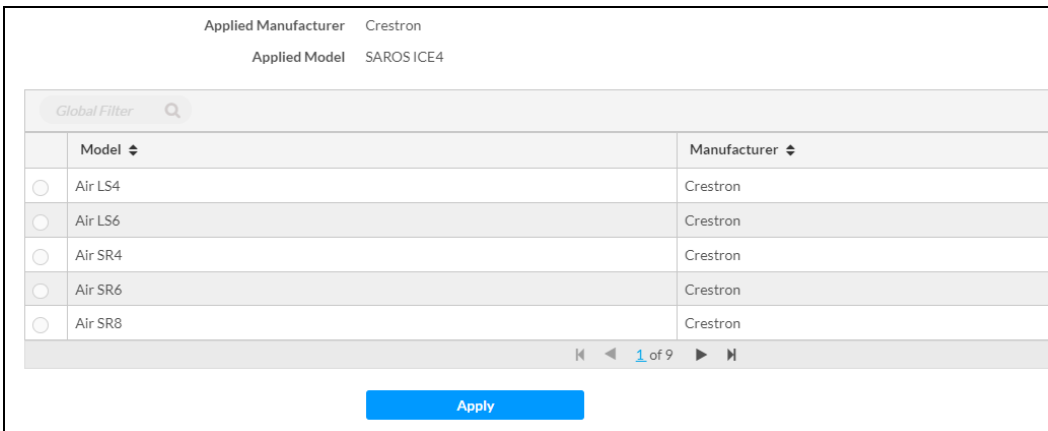

In the **Global Filter** field, enter the speaker's model name to search for its associated profile. Any speaker profiles matching the search criteria are displayed.

To apply a speaker profile:

1. Select a speaker profile.
2. Select **Apply**.

The equalizer, impedance, and speaker protection settings of the zone are updated as per the applied speaker profile.

After applying a speaker profile, the **Speaker Configuration** and **Equalizer** settings for the zone can still be edited. The **Configure Speaker Profile** section will display a notification if these settings were altered after the speaker profile was applied.



Speaker Configuration

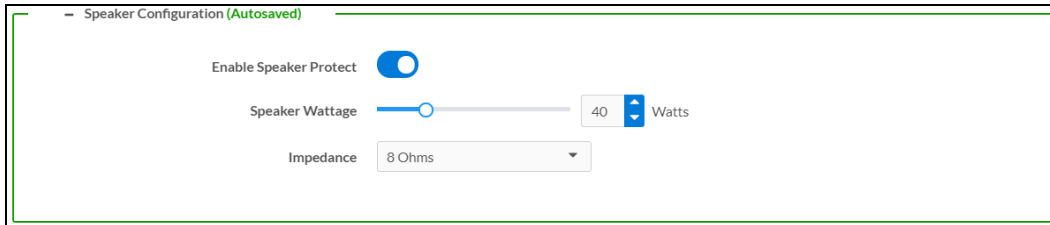

1. Set the **Enable Speaker Protect** toggle to the right position to enable speaker protection for the zone output. Set the toggle to the left position to disable speaker protection. By default, **Enable Speaker Protect** is set to the left position.
2. To set the maximum output wattage, do one of the following:
 - Move the **Speaker Wattage** slider to the right to increase or to the left to decrease the maximum peak amplifier wattage that can be output to the speaker.
 - Use the **Watts** arrows to increase or decrease the maximum peak amplifier wattage that can be output to the speaker. Values range from 5 W to 150 W, adjustable in increments of 1 W.
 - Manually enter a value in the **Speaker Wattage** field.
3. Select the impedance of the speaker on a selected zone from the **Impedance** drop-down menu. Values are **4 Ohms**, **8 Ohms**, and **Bridged**.

Casting

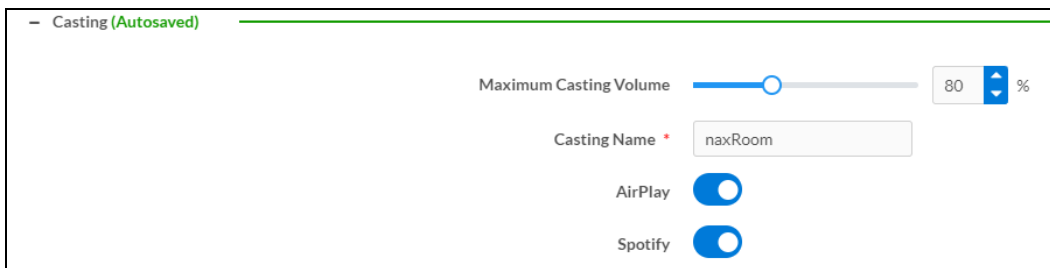

The **Casting** section is used to enable or disable the ability of third-party devices to cast audio to the DM NAX output zone, as well as set a maximum casting volume and friendly name for the zone.

To configure **Casting**:

1. **Maximum Casting Volume** is an alternate value for the **Maximum** volume set under [Minimum/Maximum Volume on page 212](#), applied to the zone only when a casting service is routed to it. To set the maximum casting volume, do one of the following:

- Move the **Maximum Casting Volume** slider right to increase or left to decrease the maximum volume.
- Use the arrows to increase or decrease the maximum casting volume. Values range from 70% to 100%, adjustable in increments of 1%.
- Manually enter a value in the **Maximum Casting Volume** field.

NOTE: If the **Maximum Casting Volume** value is higher than the regular **Maximum** volume value, the **Maximum** value will be applied instead.

2. A custom casting name (for example, "Living Room") must be entered so that a name for the zone will be displayed in the list of available casting destinations when initiating a stream. Enter this friendly name in the **Casting Name** field.

NOTE: Ensure that the **Casting Name** field is populated as any field with an asterisk (*) is mandatory.

Once AirPlay® and/or Spotify Connect™ are enabled, this name will be displayed as an available destination on the casting device.

To configure Apple AirPlay® casting:

1. Set the **AirPlay** toggle to the right to enable AirPlay casting to the zone's associated media player. Set the **AirPlay** toggle to the left to disable AirPlay casting to the associated media player.

To configure Spotify Connect™ casting:

1. Set the **Spotify** toggle to the right to enable Spotify Connect casting to the zone's associated media player. Set the **Spotify** toggle to the left to disable Spotify Connect casting to the associated media player.

To stream media from an iOS device or Spotify app to a zone in your distributed audio system, refer to the [DM-NAX-8ZSA Quick Start](#).

To stream media from a Roon® streaming device to a zone in your distributed audio system:

1. Enable Apple AirPlay casting for each DM NAX zone.
2. Launch the Roon desktop app.
3. Open the Roon app menu and navigate to the **Settings** submenu, then select **Audio**. A table of discovered network devices that the Roon device can stream to will be displayed. Any devices that previously have been enabled for Roon casting are listed under the **Connected to Core** section, and the rest of the discovered devices are listed under **Other network devices**.
4. Find each of the DM NAX zones in the **Other network devices** list, then select **Enable** for each zone to connect it to the Roon Core® for casting.

- Return to the Roon app home page and select the speaker icon at the bottom right. Select a DM NAX zone from the list of available casting destinations. With a zone selected, start a media stream, and the Roon device will cast the streaming audio to the zone.

Speaker/Faults

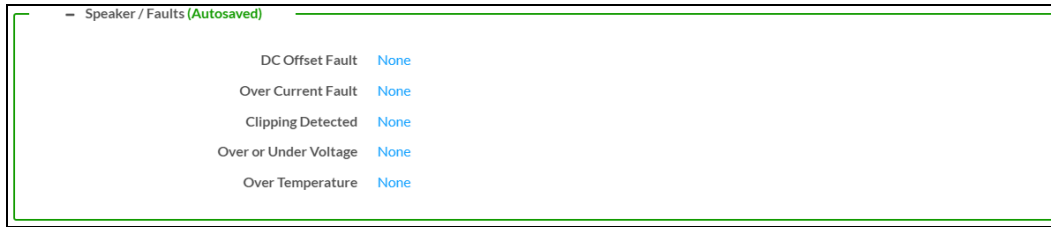

The Speaker/Faults section is a read-only field that displays the status of the **DC Offset Fault**, **Over Current Fault**, **Clipping Detected**, **Over or Under Voltage**, and **Over Temperature** detectors for the zone output. If clipping or a given fault type is detected, then its corresponding readout displays **Fault Detected** in red. Otherwise, it displays **None** in blue.

Line Out

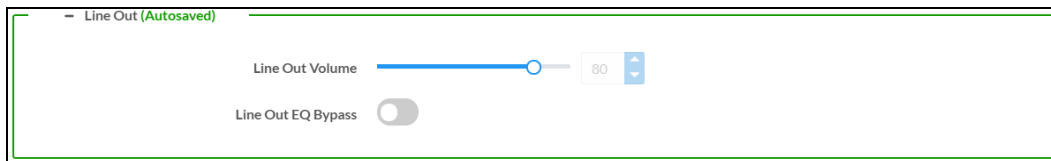

Line Out Volume controls the volume level of the corresponding line-level output on the DM NAX device. This setting is only available on zones 1 through 4 of the DM-NAX-8ZSA, as zones 5 through 8 do not have a corresponding line-level output. The Line Out Volume is only applied when **Line Out EQ Bypass** is enabled.

- To set the line out volume, do one of the following:
 - Move the **Line Out Volume** slider to the right to increase or to the left to decrease the line out volume.
 - Use the arrows to increase or decrease the line out volume. Values range from 0 to 100, adjustable in increments of 1. This range in dB is -80 dB to 20 dB.
 - Manually enter a value in the **Line Out Volume** field.
- Set the **Line Out EQ Bypass** toggle to the right position to have the line-level output signal bypass the zone's equalizer settings. Set the toggle to the left position to have the line-level output signal pass through the zone's equalizer. By default, **Line Out EQ Bypass** is disabled.

NOTE: When the **Line Out EQ Bypass** setting is disabled, the line-level output's level will mirror the speaker output's **Zone** volume control. This allows for a variable signal level in applications where the line-level output is connected to an uncontrolled device such as powered speakers. If the **Line Out EQ Bypass** setting is enabled, the **Line Out Volume** slider can be used to set a fixed level for the line-level output. This level will not be affected by the speaker output **Zone** volume controls, so this configuration is better suited to applications where the line output is connected to a controlled amplifier with its own level adjustment.

Signal Generator

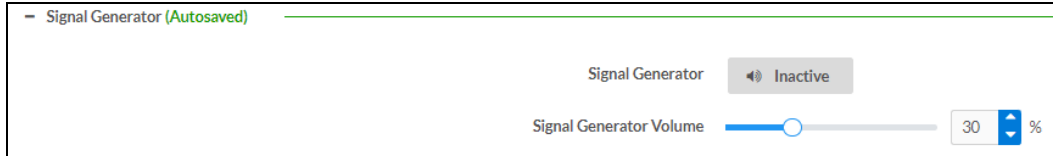

The DM-NAX-8ZSA has a built-in signal generator that allows an integrator to send an audio signal to any number of selected zones to test output functionality.

1. To route the signal generator to the zone output, select **Signal Generator** so that it displays **Active** and is highlighted in blue. To unroute the signal generator on the zone output, select **Signal Generator** so that it displays **Inactive** and is highlighted in grey. By default, the signal generator is not routed to the zone output.

NOTES:

- There is only one signal generator built-in to the DM NAX device. Each zone has its own button to enable or disable the signal generator from passing signal to that output. Setting the signal generator to **Inactive** on a given zone output only breaks the route for that output and does not stop it from playing back in other zones.
- The **Signal Generator Volume** control is a local control that does not affect the signal generator's volume on other zone outputs. Only the settings under **Advanced Signal Generator** are applied universally to all zones of the DM NAX device.

2. To adjust the signal generator's volume, do one of the following:
 - Move the **Signal Generator Volume** slider right to increase or left to decrease the volume.
 - Use the arrows to increase or decrease the signal generator volume. Values range from 0 to 100, adjustable in increments of 1.
 - Manually enter a value in the **Signal Generator Volume** field.

Advanced Signal Generator

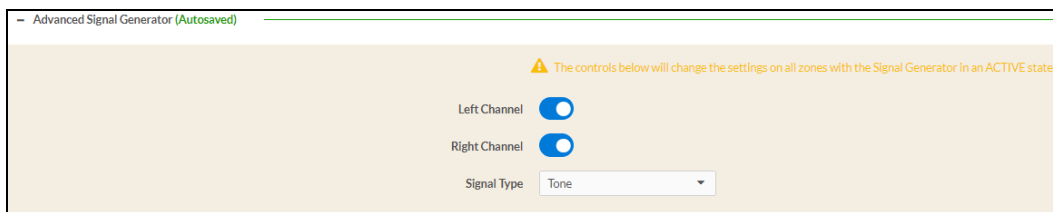

The advanced signal generator settings control the built-in signal generator directly, and are applied universally to all output zones of the DM NAX device. The signal type for the generator can be set, and the left and right channels of the test signal can be individually enabled or disabled.

1. Set the **Left Channel** toggle to the right position to enable the left channel of the signal. Set the toggle to the left position to disable the left channel. By default, **Left Channel** is enabled.
2. Set the **Right Channel** toggle to the right position to enable the right channel of the signal. Set the toggle to the left position to disable the right channel. By default, **Right Channel** is enabled.

3. Select an audio test signal type from the **Signal Type** drop-down menu. The available signal types are:
 - **Tone:** Generates a 1 kHz sine wave tone.
 - **Pink Noise:** Generates pink noise.
 - **White Noise:** Generates white noise.

Equalizer Settings

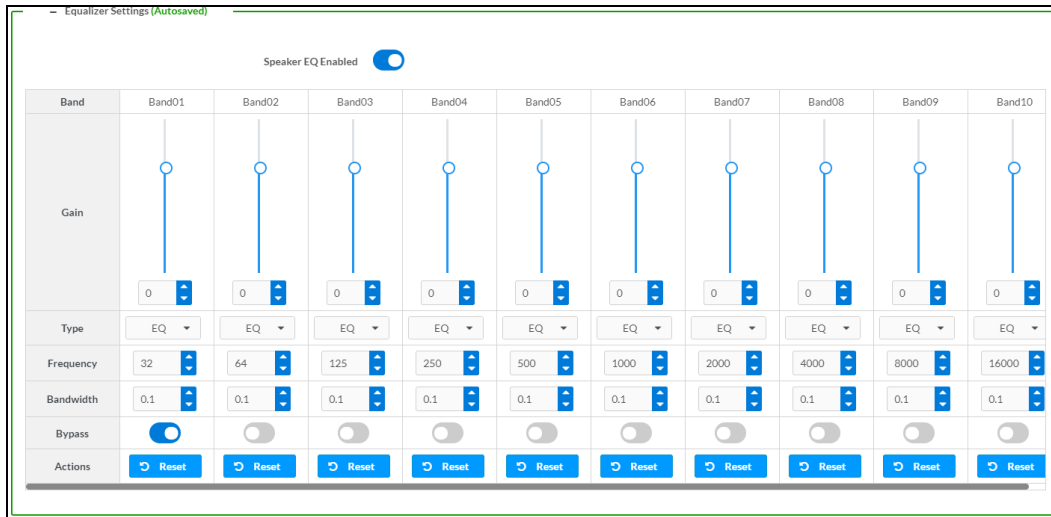

Each zone output of the DM-NAX-8ZSA has a dedicated ten-band equalizer that can be fully customized to tune the zone output signal to the needs of an install. Each band can have a discrete gain, filter type, center frequency, and bandwidth set, and can also be bypassed. The equalizer itself can also be bypassed using the **Speaker EQ Enabled** toggle.

1. Set the **Speaker EQ Enabled** toggle to the right position to enable the equalizer. Set the toggle to the left position to bypass the equalizer.

NOTE: When **Speaker EQ Enabled** is disabled, all equalizer bands are bypassed. This is a quick way to perform A/B testing of the entire EQ curve.

2. With the **Speaker EQ Enabled** toggle in the right position, configure the equalizer bands.
 - a. To set a band's gain, do one of the following:
 - Move the **Gain** slider up to increase or down to decrease the gain.
 - Use the arrows to increase or decrease the gain. Values range from -40 dB to 20 dB, adjustable in increments of 0.1 dB.
 - Manually enter a value in the **Gain** field.

- b. Select a filter type from the **Type** drop-down menu. By default, all bands are set to the **EQ** filter type. Some filter types will disable other settings in their respective band while enabled. For example, selecting the **LowPass** filter type for a band will disable that band's **Gain** and **Bandwidth** settings, since the **LowPass** filter applies a fixed roll-off slope at a set frequency. The available filter types are:
- **EQ:** a fully parametric filter that can boost or cut a range of frequencies.
 - **Notch:** a parametric filter designed to more precisely cut a frequency or range of frequencies. A notch filter can achieve a narrower bandwidth than the standard **EQ** parametric filter type.
 - **TrebleShelf:** a filter that boosts or cuts all frequencies above a set frequency by a set gain.
 - **BassShelf:** a filter that boosts or cuts all frequencies below a set frequency by a set gain.
 - **LowPass:** a filter that fully cuts all frequencies above a set frequency using a fixed roll-off slope of -12 dB per octave.
 - **HighPass:** a filter that fully cuts all frequencies below a set frequency using a fixed roll-off slope of -12 dB per octave.
- c. Set a center frequency for the equalizer band to tune a specific portion of the audible frequency spectrum. To set the center frequency, do one of the following:
- Use the arrows to increase or decrease the frequency. Values range from 20 Hz to 20 kHz, adjustable in increments of 1 Hz. Each band has a default center frequency that will be applied if **Reset** at the bottom of the band is selected.
 - Manually enter a value in the **Frequency** field.
- d. Set a bandwidth to determine how wide of a frequency range is effected by the equalizer band. To set the bandwidth, do one of the following:
- Use the arrows to increase or decrease the bandwidth. Values range from 0.1 octaves to 4.0 octaves, adjustable in increments of 0.1 octave.
 - Manually enter a value in the **Bandwidth** field.
- e. The individual Bypass controls allow you to bypass a single band of equalization at a time for more granular A/B testing of a single filter. Set a band's **Bypass** toggle to the right position to bypass that band. Set the toggle to the left position to disable the bypass. By default, **Bypass** is disabled.
- f. Each equalizer band has a **Reset** that will reapply the default settings for that band.

Select **Done** to return to the **Settings** tab of the web user interface.

Bussing

The bussing feature on DM NAX devices allows an integrator to assign any number of selected zones to a fixed group of zones (bus). Zones in a bus track the other zones' volume and routing. For example, when the source or volume for one zone in the bus is adjusted, all other zones in that bus receive the same adjustment. You can create up to four buses on the DM-NAX-8ZSA.

Name	Bus Id	Included Zones
Bus01	1	Zone6, Zone7
Bus02	2	Choose Zones
Bus03	3	Choose Zones
Bus04	4	Choose Zones

Configure Bussing

1. If needed, enter a friendly name for each bus in its **Name** field.
2. Select any number of zones from the **Included Zones** drop-down menu.

NOTE: Each zone can be a member of only one bus. Any zones that are already a member of another bus will not be shown in the **Included Zones** drop-down.

3. Select **Save Changes** in the top right corner.

Inputs

The **Inputs** section is used to configure the **Name**, **Compensation**, and **Mute** attributes of the available analog, digital, and media streaming inputs on the DM-NAX-8ZSA.

A total of 16 inputs are available on the DM-NAX-8ZSA, including the 8 physical input connectors on the device's rear panel and the 8 internal media players used for media streaming services.

Name	TOSLINK1	TOSLINK2	S/PDIF1	S/PDIF2	RCA1	RCA2	RCA3	RCA4
Gain (db)								
Signal Present								
Clipping Detected								
Mute								

Configure Inputs

1. If needed, enter a friendly name for each input in its **Name** field.
2. To set a level compensation adjustment for a given input, do one of the following:
 - Move the **Compensation** slider up to increase or down to decrease the compensation. Compensation increases or decreases the level of the incoming audio signal on any of the physical inputs on the device's rear panel. Compensation is not available for any of the internal media players.
 - Use the **db** arrows to increase or decrease the compensation. Values range from -10 dB to 10 dB, adjustable in increments of 1 dB.
 - Manually enter a value in the **Compensation** field.

- To mute the signal from the corresponding input, select **Mute**. To disable the mute, select **Muted**. By default, **Mute** is disabled.

Monitor the device's input signals using the text indicators in the **Signal Present** and **Clipping Detected** columns:

- **Signal Presence** indicates whether or not a signal is detected in that zone.
- **Clipping Detected** indicates if the signal is **Clipping** or **Nominal** (non-clipping).

Use the **Global Filter** text field to filter specific inputs by name. Not all of the available inputs are shown on the first page in this section when no **Global Filter** is applied. Use  at the bottom of the table to view the next page of inputs.

DM NAX Streams

Each local input of the DM-NAX-8ZSA can be made available as a DM NAX audio-over-IP stream. This includes the eight physical inputs on the rear panel of the device and the eight internal media players.

The DM-NAX-8ZSA also supports parallel DM NAX streams for each zone output, enabling an additional transmit stream per output to mirror all routes and DSP settings of its respective zone. These parallel streams enable control of the audio signal to third-party uncontrolled AES67 devices receiving audio from the DM-NAX-8ZSA.

NOTES:

- Under the **Transmitters** section (see [Configure Transmitters](#)), the last four listed transmitters are dedicated to parallel zone outputs.
- To configure the DSP settings, see [Zone Settings](#).

Select **NAX Streams** to expand the tab and display the following information.

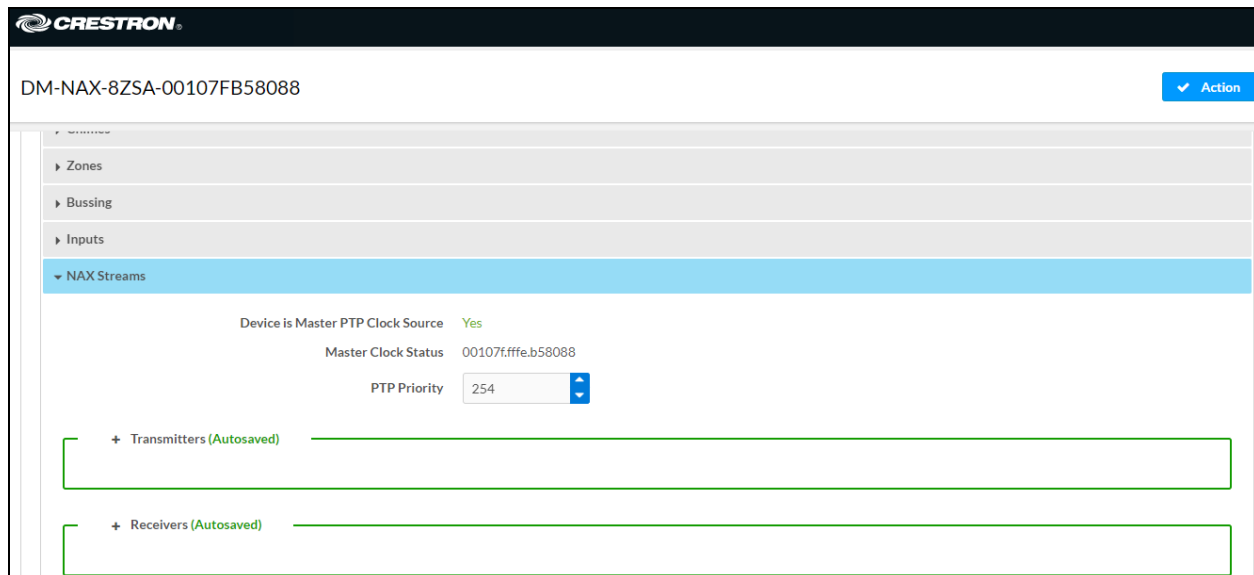

The screenshot shows the Crestron web interface for a DM-NAX-8ZSA device (ID: 00107FB58088). The 'NAX Streams' tab is selected in the left-hand navigation menu. The main content area displays the following configuration options:

- Device is Master PTP Clock Source: Yes
- Master Clock Status: 00107f.ffe.b58088
- PTP Priority: 254 (with a dropdown arrow)
- + Transmitters (Autosaved): A large empty text input field.
- + Receivers (Autosaved): A large empty text input field.

- **Device is Leader PTP Clock Source** indicates whether the DM NAX device's PTP clock is the leader clock on the network. **Yes** will be displayed in green when the local DM-NAX-8ZSA's clock is the PTP leader clock and **No** will be displayed in red when another PTP clock on the network is operating as the leader clock.
- **Leader Clock Status** displays the Leader Clock ID of the device on the network that is currently acting as the leader clock.
- **PTP Priority**: This sets the priority of the local DM NAX device's PTP clock relative to other clocks on the network. The default setting is 254 (one increment higher than the lowest possible value) so that the DM-NAX-8ZSA will only operate as the leader clock if no other PTP leader is present on the network. Valid values range from 1 to 255.

Configure Transmitters

The screenshot shows the 'NAX Streams' configuration page. At the top, it indicates 'Device is Master PTP Clock Source: No', 'Master Clock Status: 00107ffffe.9cc314', and 'PTP Priority: 254'. Below this is a section for 'Transmitters (Autosaved)' containing a table with 8 rows. Each row represents a transmitter configuration with columns for Audio Source, Stream, Nax Stream Address, Nax Stream Name, Status, and Actions.

Audio Source	Stream	Nax Stream Address	Nax Stream Name	Status	Actions
Digital Input 1	Stream01	0.0.0.0	TOSLINK100.10.71b5.80.88	Stream Stopped	▶ ◻ ⚙
Digital Input 2	Stream02	0.0.0.0	TOSLINK200.10.71b5.80.88	Stream Stopped	▶ ◻ ⚙
Digital Input 3	Stream03	239.8.0.32	S/PDIF1300.10.71b5.80.88	Stream Started	▶ ◻ ⚙
Digital Input 4	Stream04	0.0.0.0	S/PDIF2400.10.71b5.80.88	Stream Stopped	▶ ◻ ⚙
Analog Input 5	Stream05	0.0.0.0	RCA1500.10.71b5.80.88	Stream Stopped	▶ ◻ ⚙
Analog Input 6	Stream06	0.0.0.0	RCA2600.10.71b5.80.88	Stream Stopped	▶ ◻ ⚙
Analog Input 7	Stream07	0.0.0.0	RCA3700.10.71b5.80.88	Stream Stopped	▶ ◻ ⚙
Analog Input 8	Stream08	0.0.0.0	RCA4800.10.71b5.80.88	Stream Stopped	▶ ◻ ⚙

NOTE: To configure transmitters not shown on the current page of the table, select the ▶ icon to display the next page of eight transmitters.

To configure a DM NAX transmit stream:

1. Enter a valid multicast address in the **NAX Stream Address** field.
2. Enter a name in the **NAX Stream Name** field by which the stream can be identified. This stream name is associated with the DM NAX stream's multicast address by other DM NAX or AES67 devices, like a device hostname that resolves to a given IP address.
3. **Status** indicates whether a stream is transmitting or not. When the stream has started or stopped, the **Status** column will update accordingly.
4. Select the configure icon ⚙ in the **Actions** column. The **Configure** dialog appears:

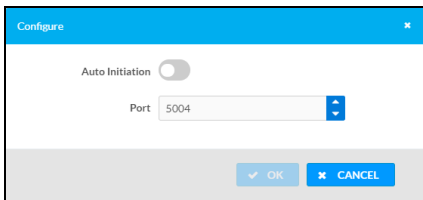

5. Set the **Auto Initiation** toggle to the right position to enable auto initiation. Set the toggle to the left position to disable auto initiation.
 - If **Auto Initiation** is enabled for a given stream, the stream will begin transmitting automatically and will be available as a multicast stream on your network at the specified multicast address.
 - If **Auto Initiation** is disabled for the input, the stream will not begin transmitting until it is manually initiated.
6. To set the port number, do one of the following:
 - Use the arrows to increase or decrease the port number by increments of 1.
 - Manually enter a port number in the **Port** field. The default port number for DM NAX streams is 5004.
7. Select **OK** to save or select **Cancel** to cancel the changes.

Configure Receivers

Zone Name	Stream	Current Stream Address	Requested Stream Address	Status	Actions
Zone1	Stream01	0.0.0.0	0.0.0.0	Stream Stopped	▶ ■ ⚙
Zone2	Stream02	0.0.0.0	0.0.0.0	Stream Stopped	▶ ■ ⚙
Zone3	Stream03	0.0.0.0	0.0.0.0	Stream Stopped	▶ ■ ⚙
Zone4	Stream04	0.0.0.0	0.0.0.0	Stream Stopped	▶ ■ ⚙
Zone5	Stream05	0.0.0.0	0.0.0.0	Stream Stopped	▶ ■ ⚙
Zone6	Stream06	0.0.0.0	0.0.0.0	Stream Stopped	▶ ■ ⚙
Zone7	Stream07	0.0.0.0	0.0.0.0	Stream Stopped	▶ ■ ⚙
Zone8	Stream08	0.0.0.0	0.0.0.0	Stream Stopped	▶ ■ ⚙

1. Enter the multicast address of a transmitting stream in the **Requested Stream Address** field to subscribe the receiver to the stream.
2. Select the configure icon ⚙ in the **Actions** column. The **Configure** dialog appears:

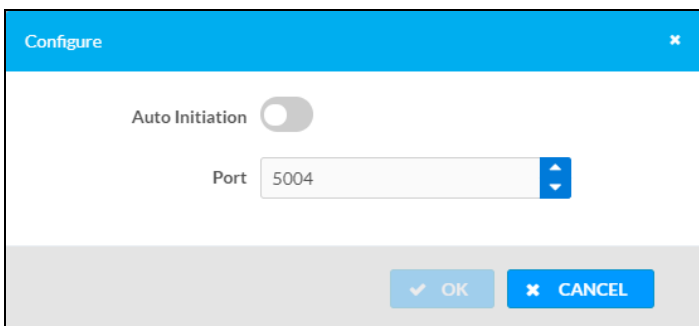





3. Set the **Auto Initiation** toggle to the right position to enable auto initiation. Set the toggle to the left position to disable auto initiation.
 - If **Auto Initiation** is enabled, the stream will begin automatically when the receiver subscribes to the transmitter.
 - If **Auto Initiation** is disabled, the stream will not begin until it is manually initiated.
4. To set the port number, do one of the following:
 - Use the arrows to increase or decrease the port number by increments of 1.
 - Manually enter a port number in the **Port** field. The default port number is 5004.
5. Select **OK** to save or select **Cancel** to cancel the changes.

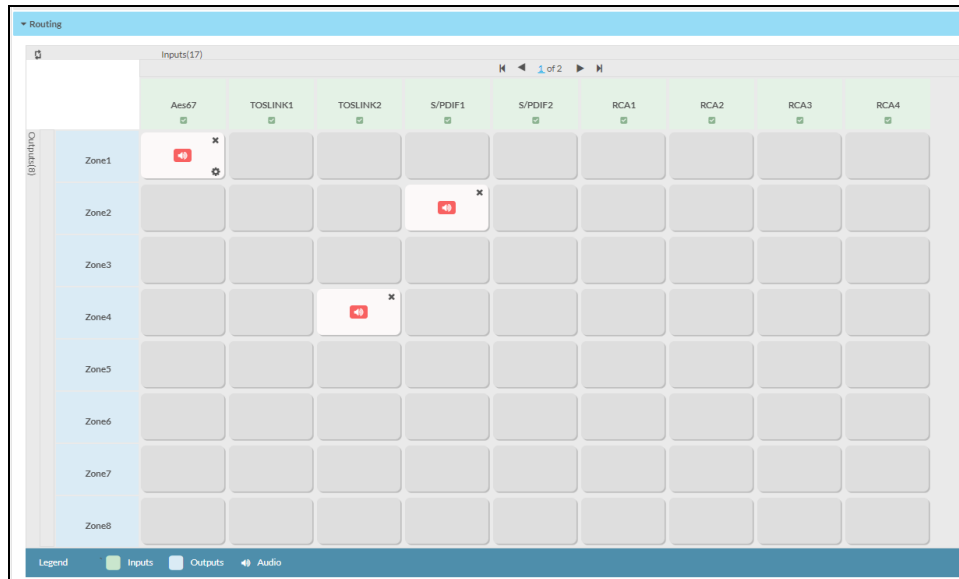

Routing

The **Routing** section is used to route a local input, media player, or AES67 stream to a Zone on the DM-NAX-8ZSA.

NOTE: To receive an AES67 stream from Dante devices, see [OLH 1001151](#).



- To route an input to a zone, select the box in the routing matrix where the zone's row overlaps the corresponding input's column. Once a route is made,  appears.
- To break a given route select  or .
- To route a single input to all zones, select the  icon under the input's name.

Use the arrows ( or ) at the top of the matrix to change pages to view all available inputs.

To select a specific DM NAX/AES67 stream when AES67 is selected as the source for a zone:

- Select the gear icon  to display the list of all DM NAX/AES67 streams discovered on the network, then select the corresponding stream to be routed to the zone.

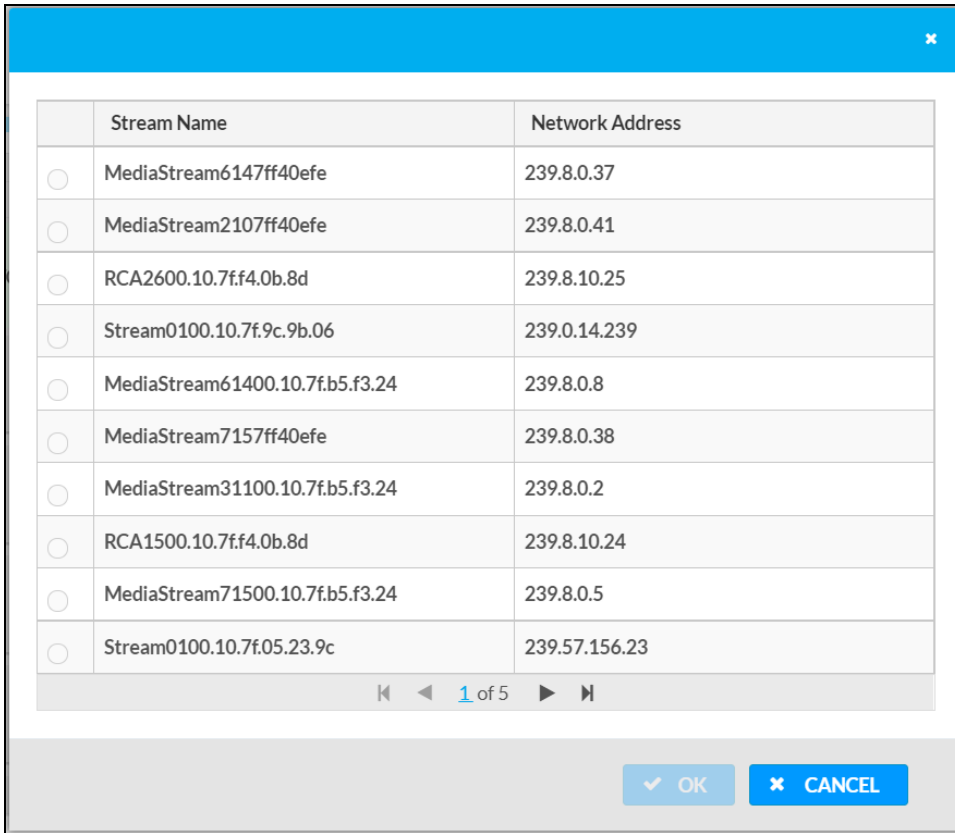

- Select **OK** to save or select **Cancel** to cancel the changes.

Streaming Services

The DM-NAX-8ZSA features eight built-in media streaming players, each of which can play back a discrete media stream from a cloud-based service or local casting device. User profiles can be created for each user of the DM NAX device with discrete credentials, enabling multiple users access to media streaming services without interfering with other users' recommendations, favorites, or playlists.

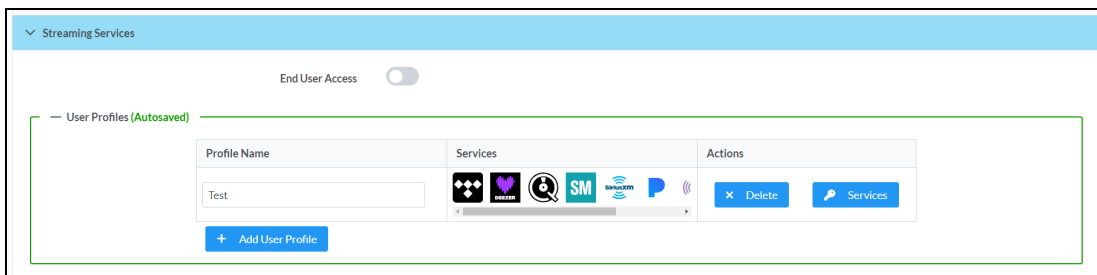

To configure Streaming Services:

1. Select **+ Add User Profile** to create a new user profile. Each user profile can contain a unique set of accounts for all supported streaming services.

2. Enter a name in the **Profile Name** field. Select **Save** to create the **User Profile**. Once the profile is created, you have the option to either **Delete** the profile, or add **Services** to it.
3. Select **Services** in the **Action** column and an **Edit Services** window appears.

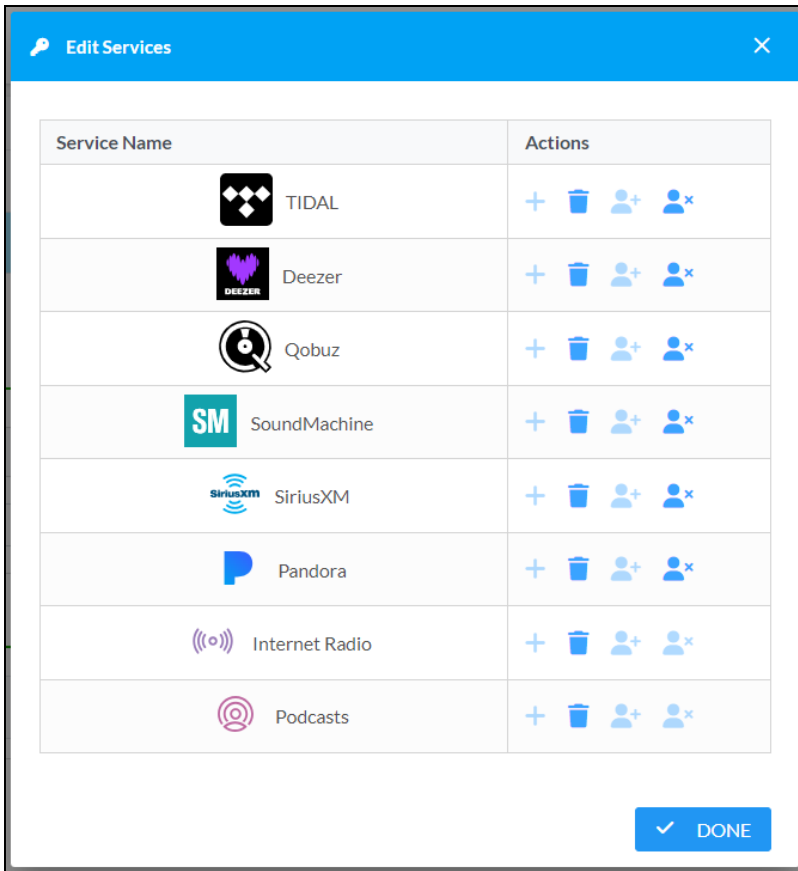

4. Select from the available Streaming Services: **TIDAL™**, **Deezer®**, **Qobuz®**, **SOUNDMACHINE®**, **SiriusXM®**, **Pandora®**, **Internet Radio**, and **Podcasts**. Select **+** or **🗑️** to add or delete the desired streaming services for each user profile.

User Authentication

User authentication is required for TIDAL, Deezer, Qobuz, SOUNDMACHINE, SiriusXM and Pandora. Select **👤+** to authorize the user.

To authenticate SiriusXM streaming:

NOTE: To determine whether to use commercial accounts, refer to the streaming service license agreement or FAQs on their respective portals. Refer to [this link](#) for SiriusXM documentation.

Enter the user credentials and select **OK**.

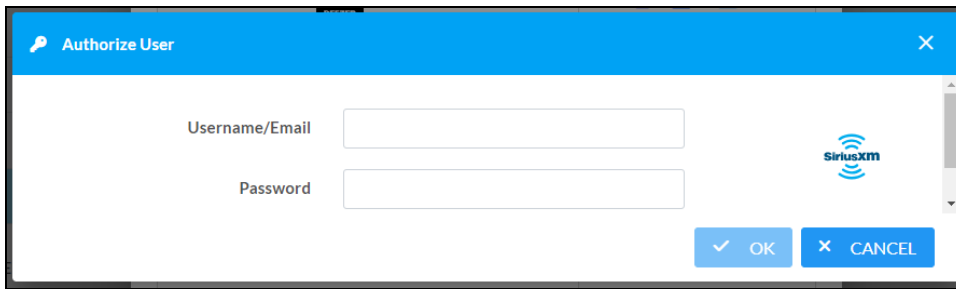

To authenticate TIDAL streaming:

1. Select the link to log in to the TIDAL portal.

NOTE: The link is valid for one minute. After one minute, the link expires, and the **Authorize URL** is shown as blank. The **Authorize User** dialogue will need to be closed and reopened.

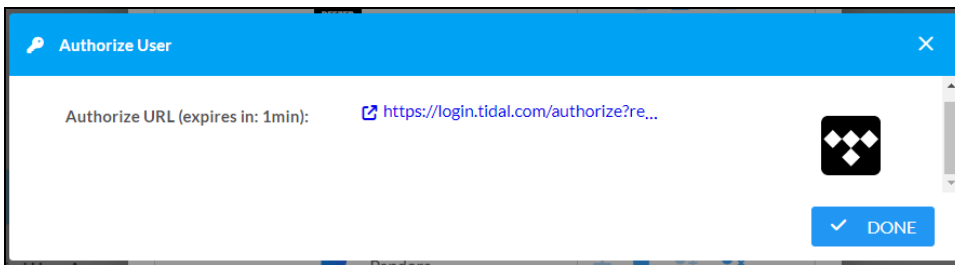

2. Select **DONE** to return to **Streaming Services**.

To authenticate Deezer streaming:

1. Select the link to log in to the Deezer portal.

NOTE: The link is valid for one minute. After one minute, the link expires, and the **Authorize URL** is shown as blank. The **Authorize User** dialogue will need to be closed and reopened.

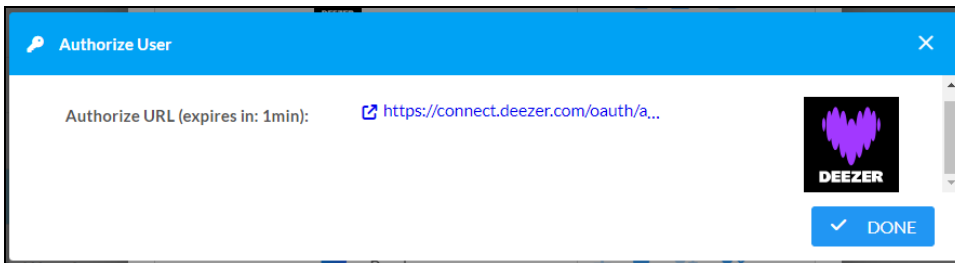

2. Select **DONE** to return to **Streaming Services**.

To authenticate Qobuz streaming:

1. Select the link to log in to the Qobuz portal.

NOTE: The link is valid for one minute. After one minute, the link expires, and the **Authorize URL** is shown as blank. The **Authorize User** dialogue will need to be closed and reopened.

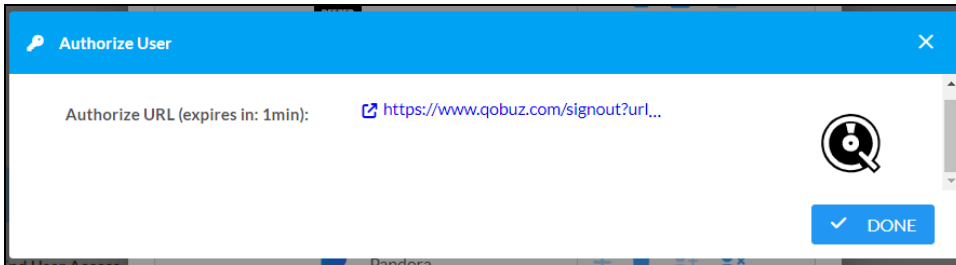

2. Select **DONE** to return to **Streaming Services**.

To authenticate SOUNDMACHINE streaming:

NOTE: To determine whether to use commercial accounts, refer to the streaming service license agreement or FAQs on their respective portals. Refer to [this link](#) for SOUNDMACHINE documentation.

1. Select the link to log in to the SOUNDMACHINE portal.

NOTE: The link is valid for one minute. After one minute, the link expires, and the **Authorize URL** is shown as blank. The **Authorize User** dialogue will need to be closed and reopened.

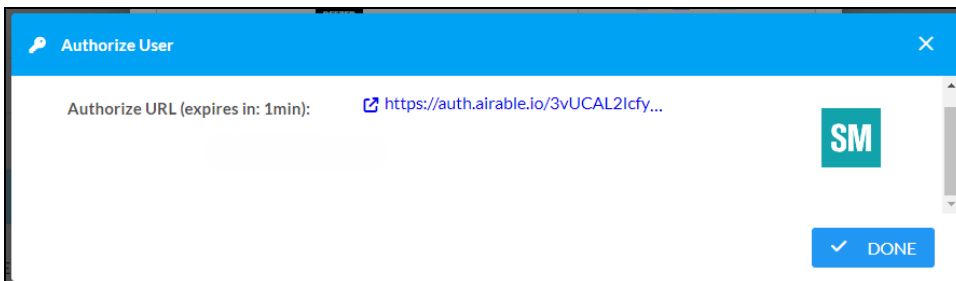

2. Log in to the SOUNDMACHINE account.

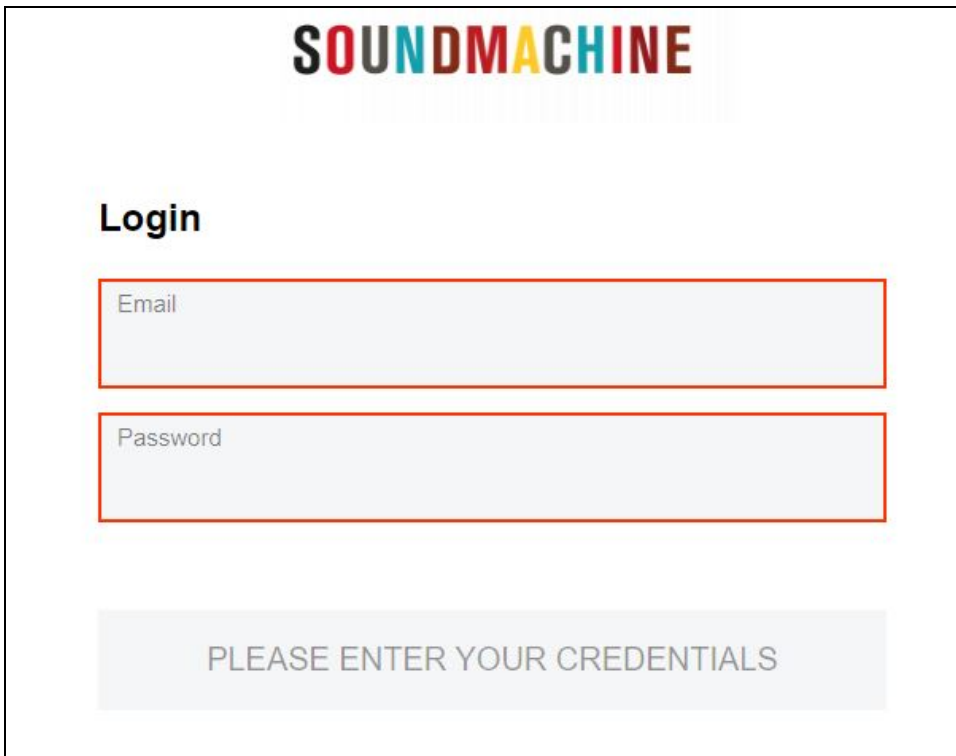

SOUNDMACHINE

Login

Email

Password

PLEASE ENTER YOUR CREDENTIALS

3. Select **DONE** to return to **Streaming Services**.

To authenticate Pandora streaming:

1. Select the  icon to copy the activation code.

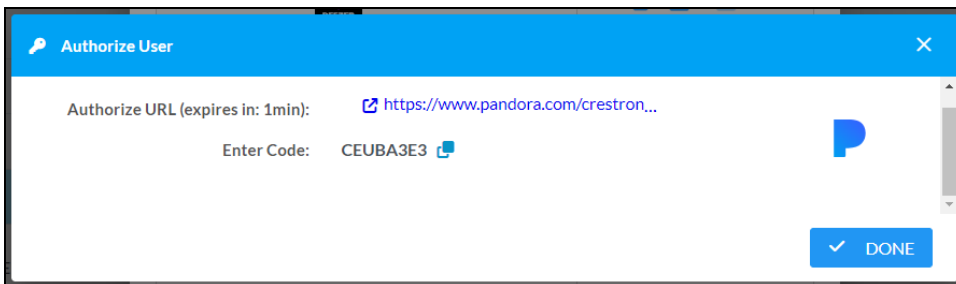

Authorize User

Authorize URL (expires in: 1min): <https://www.pandora.com/crestron...>

Enter Code: CEUBA3E3 



DONE

2. Select the link to register the device. The **Device Activation** page is displayed.

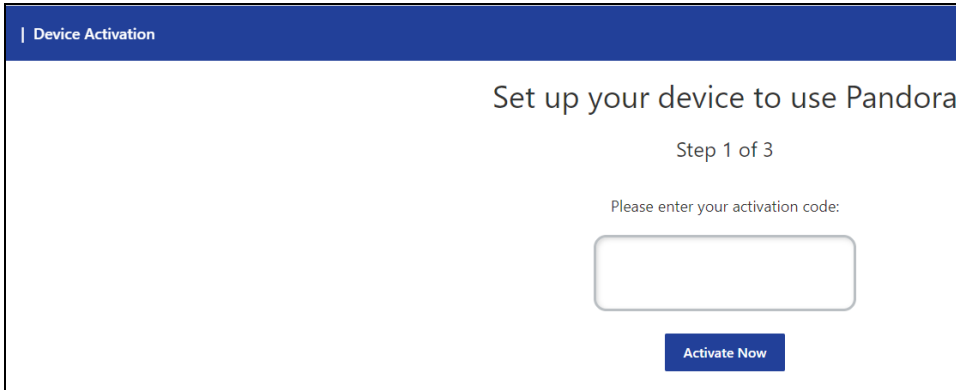

NOTE: The link is valid for one minute. After one minute, the link expires, and the **Authorize URL** and **Enter Code** are shown as blank. The **Authorize User** dialogue will need to be closed and reopened.

3. Paste the activation code in the **Please enter your activation code** field and select **Activate Now**.
4. Log in to the Pandora account.
5. Select **DONE** to return to **Streaming Services**.

Port Selection

The **Port Selection** feature allows the device's internal network traffic to be managed and segregated based on traffic type. Internal VLANs are used to segment device management and streaming service traffic to a separate physical device Ethernet port than audio-over-IP streaming traffic. With Port Selection enabled on all DM NAX devices on a network, DM NAX and AES67 network traffic can be physically separated from the control network onto a dedicated audio network.

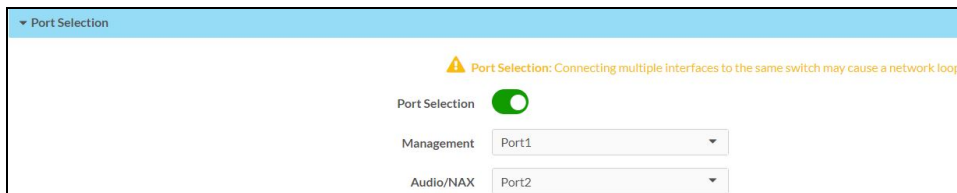

To configure **Port Selection**:

1. Set the **Port Selection** toggle to the right position to enable **Port Selection**. Set the toggle to the left position to disable **Port Selection**. By default, **Port Selection** is disabled.

NOTE: **Port1** and **Port2** correspond to the Ethernet adapters labeled **1** and **2** on the rear panel of the DM-NAX-8ZSA, respectively.

2. With **Port Selection** enabled:

- a. Select an Ethernet port from the **Management** drop-down menu to designate which Ethernet port on the rear panel of the device will handle network traffic relating to device configuration, streaming services, and the device's connection to a control system.

NOTES:

- To access streaming services, the Management port must be connected to a network with internet access.
- The Management port determines your connection to the web interface. Changing the port value can result in losing your connection to the device via the web interface.

- b. Select an Ethernet port from the **Audio/NAX** drop-down menu to designate which Ethernet port on the rear panel of the device will handle audio-over-IP streaming network traffic.

3. Select **Save** changes to apply the new settings.

NOTE: Making changes to **Port Selection** settings will require a reboot.

Security

Select the **Security** tab to configure security for users and groups and to allow different levels of access to the DM-NAX-8ZSA functions. By default, security is disabled.

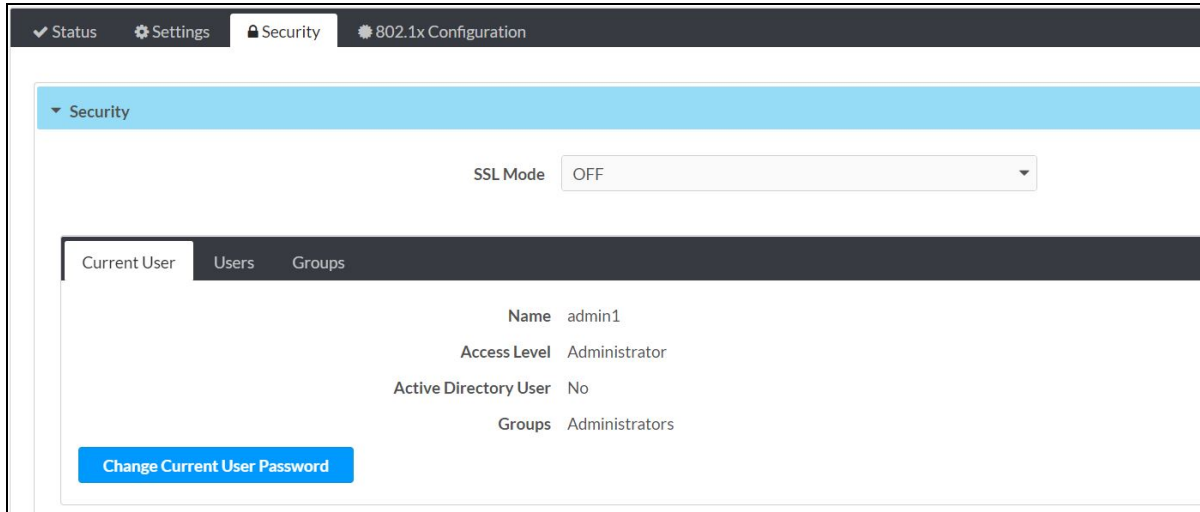

Select **Encrypt and Validate**, **Encrypt**, or **OFF** in the **SSL Mode** drop-down menu, to specify whether to use encryption. By default, SSL Mode is set to **OFF**.

Current User

Select the **Current User** tab to view read-only information or to change the password for the current user.

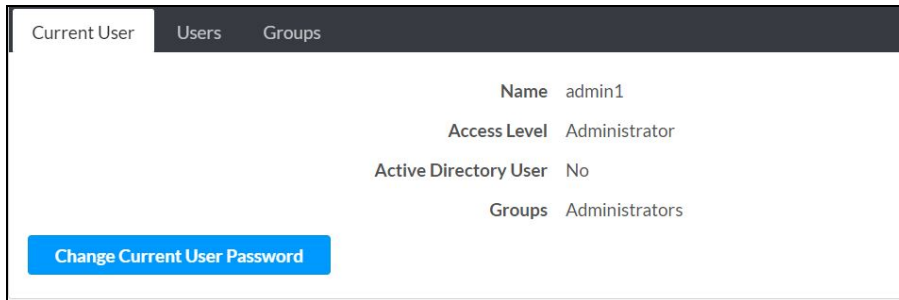

1. Select **Change Current User Password** to provide a new password for the current user.
2. In the **Change Password** dialog, enter the current password in the **Current Password** field, the new password in the **Password** field, and then re-enter the same new password in the **Confirm Password** field.

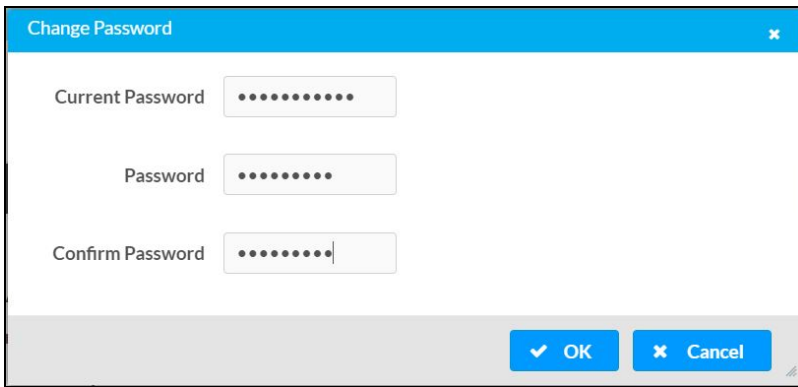

A dialog box titled "Change Password" with a close button (X) in the top right corner. It contains three input fields: "Current Password" with 10 dots, "Password" with 8 dots, and "Confirm Password" with 8 dots and a cursor. At the bottom, there are two buttons: "OK" with a checkmark icon and "Cancel" with an X icon.

3. Select **OK** to save or select **Cancel** to cancel the changes.

Users

Select the **Users** tab to view and edit user settings. The **Users** tab can be used to add or remove local and Active Directory users and preview information about users.

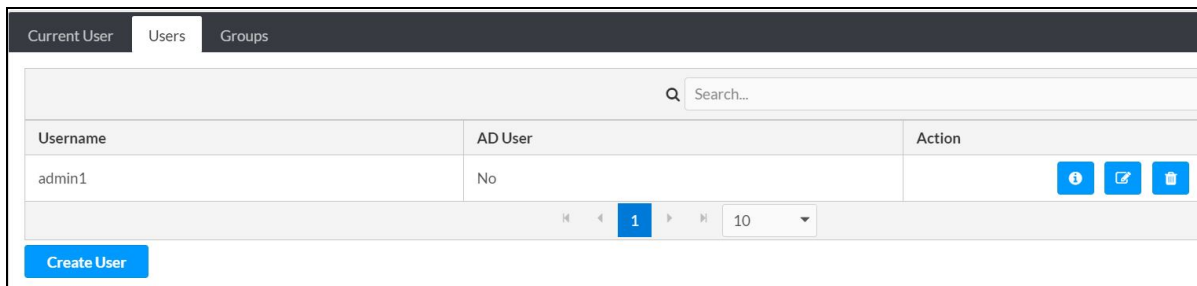

The "Users" tab interface shows a navigation bar with "Current User", "Users", and "Groups". Below is a search bar labeled "Search...". A table lists users with columns for "Username", "AD User", and "Action". The first row shows "admin1" with "No" in the AD User column and three action icons (info, edit, delete). At the bottom, there are navigation arrows, a page number "1", and a dropdown menu set to "10". A "Create User" button is located at the bottom left.

Username	AD User	Action
admin1	No	[Info] [Edit] [Delete]

Use the **Search Users** field to enter search term(s) and display users that match the search criteria.

If users listed in the **Users** table span across multiple pages, navigate through the list of users by selecting a page number or by using the left or right arrows at the bottom of the **Users** pane to move forward or backward through the pages.

Each page can be set to display 5, 10, or 20 users by using the drop-down menu to the right of the navigation arrows.

Information about existing users is displayed in table format and the following details are provided for each user.

- **Username:** Displays the name of the user.
- **AD User:** Displays whether the user requires authentication using Active Directory.
Select the corresponding icon in the Actions column to view detailed user information or to delete the user.

To create a new user, select **Create User**.

Create a New Local User

1. Select **Create User** in the **Users** tab.
2. In the **Create User** dialog, enter the following:

- a. Enter a user name in the **Name** field. A valid user name can consist of alphanumeric characters (letters a-z, A-Z, numbers 0-9) and the underscore "_" character.
- b. Enter a password in the **Password** field; re-enter the same password in the **Confirm Password** field.
- c. Assign the access level by selecting one or more groups from the **Groups** drop-down list.

NOTE: Make sure that the **Active Directory User** toggle is disabled.

3. Select **OK** to save or select **Cancel** to cancel the changes.

Add an Active Directory User

Users cannot be created or removed from the Active Directory server, but access can be granted to an existing user in the Active Directory server.

To grant access to an Active Directory user, you can either add the user to a local group on the DM-NAX-8ZSA, or add the Active Directory group(s) that they are a member of to the DM-NAX-8ZSA.

To add an Active Directory user.

1. Select **Create User**.
2. In the **Create User** dialog, enter the following.

- a. Enter a user name in the **Name** field in the format "Domain\UserName", for example "crestronlabs.com\JohnSmith". Valid user names can contain alphanumeric characters (letters a-z, A-Z, numbers 0-9) and the underscore "_" character.
- b. Select one or more groups from the **Groups** drop-down list.

NOTE: Make sure that the **Active Directory User** toggle is set to enabled.

3. Select **OK** to save or select **Cancel** to cancel the changes.

Delete User

Select the trashcan icon  in the **Actions** column to delete the user. Select **Yes** when prompted to delete the user or **No** to cancel the deletion.

After a user is removed from a group, they lose any access rights associated with that group. Note that the user account is not deleted by the delete user operation.

View User Details

Select the information icon  in the **Actions** column to view information for the selected user. The **User Details** dialog displays the following information for the selected user.

- **Name:** Displays the name of the selected user.
- **Active Directory User:** Displays whether the user is an Active Directory user.
- **Group:** Displays group(s) the selected user is part of.

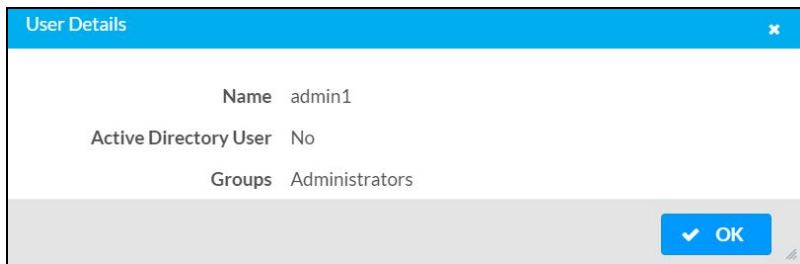

Select **OK** to close the **User Details** dialog and to return to the **Users** tab.

Update User Details

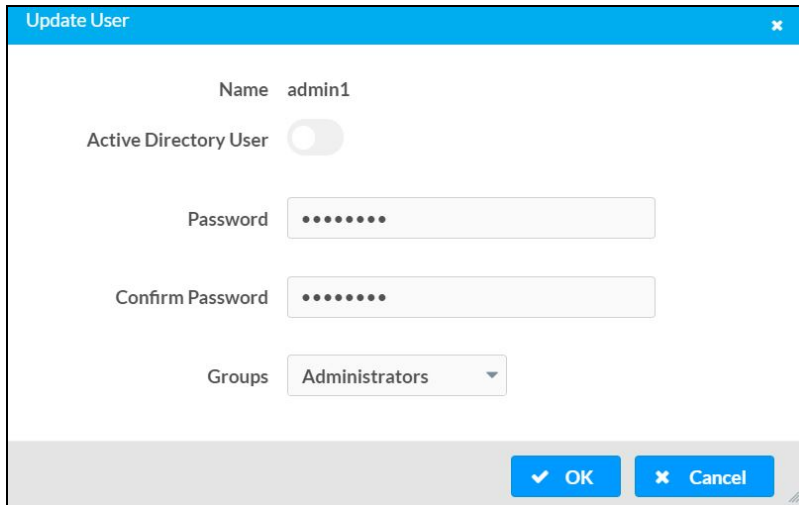

1. Select the edit icon  in the **Actions** column to update information for the selected user.
2. Enter a password in the **Password** field; re-enter the same password in the **Confirm Password** field.
3. Select one or more groups to assign the user to from the **Groups** drop-down list.
4. Select **OK** to save or select **Cancel** to cancel the changes.

The **Update User** dialog also displays the following read-only information for the selected user.









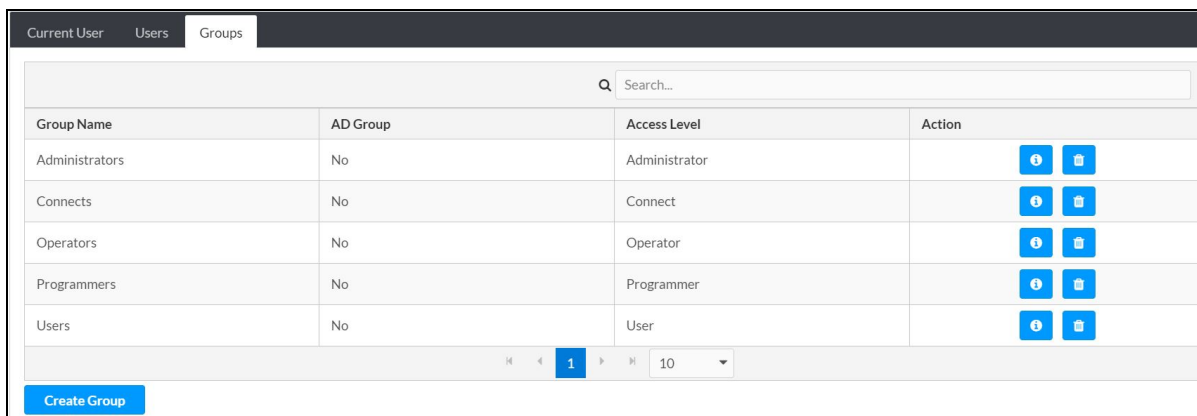

- **Name:** Displays the name of the user.
- **Active Directory User:** Displays whether the user is an Active Directory user.

Groups

Select the **Groups** tab to view and edit group settings. The **Groups** tab can be used to add local and Active Directory groups, remove local and Active Directory groups, and preview information about a group.

Use the **Search Groups** field to enter search term(s) and display groups that match the search criteria.





Group Name	AD Group	Access Level	Action
Administrators	No	Administrator	 
Connects	No	Connect	 
Operators	No	Operator	 
Programmers	No	Programmer	 
Users	No	User	 

If groups listed in the **Groups** table span across multiple pages, navigate through the groups by selecting a page number or by using the left or right arrows at the bottom of the **Groups** pane to move forward or backward through the pages.

Additionally, each page can be set to display 5, 10, or 20 groups by using the drop-down menu to the right of the navigation arrows.

Existing groups are displayed in a table and the following information is provided for each group:

- **Group Name:** Displays the name of the group.
- **AD Group:** Displays whether the group requires authentication using Active Directory.
- **Access Level:** Displays the predefined access level assigned to the group (Administrator, Programmer, Operator, User, or Connect).

Select the corresponding icon in the **Actions** column to view detailed group information  or to delete  selected group.

Select **Create Group** in the **Groups** tab to create new group.

Create Local Group

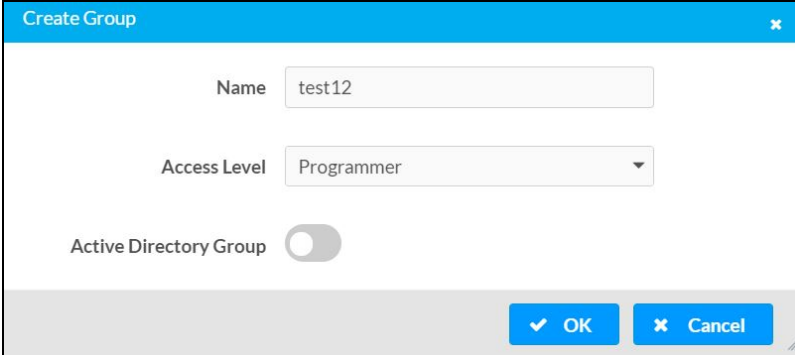

1. Select **Create Group**.
2. In the **Create Group** dialog, enter the following:
 - a. Enter the group name in the **Name** field.
 - b. Assign the group access level by selecting a predefined access level (Administrator, Connect, Operator, Programmer, User) from the **Access Level** drop-down list.

NOTE: Make sure that the **Active Directory Group** toggle is disabled.

3. Select **OK** to save. Select **Cancel** to cancel the changes.

Add Active Directory Group

A group cannot be created or removed from the Active Directory server, but access can be granted to an existing group in Active Directory.

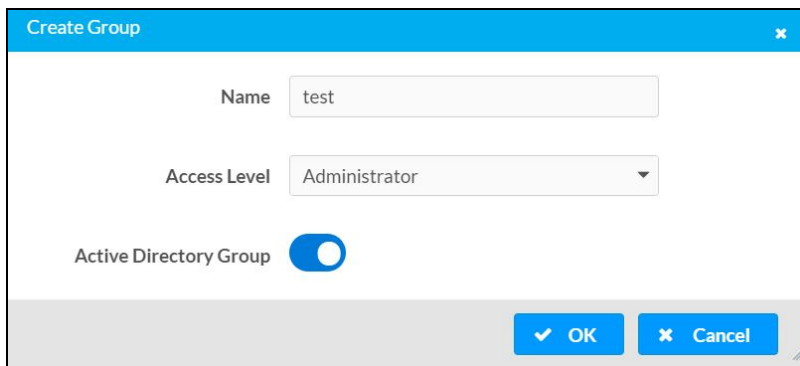

Once the group is added, all members of that group will have access to the DM-NAX-8ZSA.

1. Select **Create Group**.
2. In the **Create Group** dialog enter the following:
 - a. Enter the group name in the **Name** field, for example "Engineering Group". Note that group names are case sensitive; a space is a valid character that can be used in group names.
3. Assign the group access level by selecting a predefined access level (Administrator, Connect, Operator, Programmer, User) from the **Access Level** drop-down list.

NOTE: Make sure that the **Active Directory Group** toggle is enabled.

4. Select **OK** to save. Select **Cancel** to cancel the changes.

Delete a Group

Select the trashcan icon  in the **Actions** column to delete a group. Select **Yes** when prompted to delete the group or **No** to cancel the deletion.

When a group is deleted, users in the group are not removed from the device or Active Directory server. However, because a user's access level is inherited from a group(s), users within the deleted group will lose access rights associated with the group.

View Group Details

Select the information icon  in the **Actions** column to view information for the selected group. The **Group Details** dialog lists the following information for the selected group.

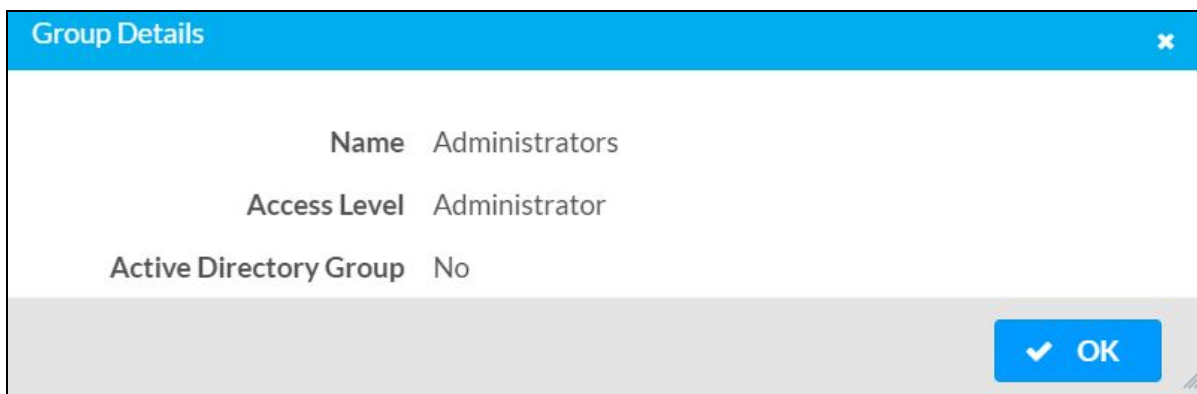

- **Name:** Displays the name of the group.
- **Access Level:** Displays the access level of the group and its users.
- **Active Directory Group:** Displays whether the group is an Active Directory group.

Select **OK** to close the **Group Details** dialog and to return to the **Groups** tab.

802.1x Configuration

The DM-NAX-8ZSA has built-in support for the 802.1X standard (an IEEE network standard designed to enhance the security of wireless and Ethernet LANs. The standard relies on the exchange of messages between the device and the network's host, or authentication server), allowing communication with the authentication server and access to protected corporate networks.

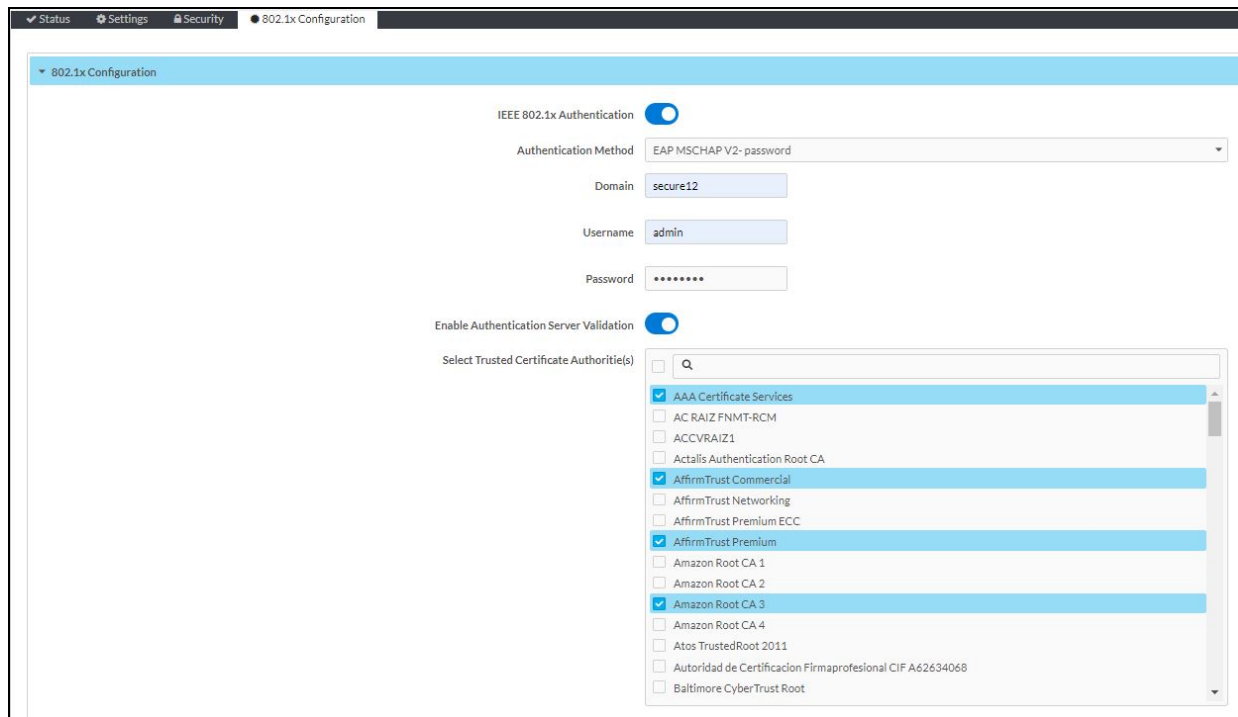

Configure DM-NAX-8ZSA for 802.1X Authentication

1. Set the **IEEE 802.1X Authentication** toggle to enabled. This will enable all options on the 802.1X dialog.
2. Select the **Authentication method: EAP-TLS Certificate** or **EAP-MSCHAP V2 Password** according to the network administrator's requirement.
3. Do either one of the following:
 - Select **EAP-TLS Certificate**: Select **Action/Manage Certificates** to upload the required machine certificate. The machine certificate is an encrypted file that will be supplied by the network administrator, along with the certificate password.
 - Select **EAP-MSCHAP V2 Password**: Enter the username and password supplied by the network administrator into the **Username** and **Password** fields. This method does not require the use of a machine certificate, only the user name and password credentials.

4. If you enabled the **Enable Authentication Server Validation** option, this will enable the **Select Trusted Certificate Authority(ies)** list box which contains signed Trusted Certificate Authorities (CAs) preloaded into the DM-NAX-8ZSA.

Select the check box next to each CA whose certificate can be used for server validation, as specified by the network administrator.

If the network does not use any of the listed certificates, the network administrator must provide a certificate, which must be uploaded manually via the **Manage Certificates** functionality.

5. If required, type the domain name of the network in the **Domain** field.
6. When the 802.1X settings are configured as desired, select **Save Changes** to save the changes to the device and reboot it. Select **Revert** to cancel any changes.

DM-NAX-4ZSA-50

This section describes how to configure the DM-NAX-4ZSA-50.

Web Interface Configuration

The DM-NAX-2XLRI-1G web interface allows you to view status information and configure network and device settings.

Access the Web Interface

To access the web interface, do either of the following:

- [Access the Web Interface with a Web Browser on page 248](#)
- [Access the Web Interface With the Crestron Toolbox™ Application on page 250](#)

The web interface is accessed from a web browser. The following table lists operating systems and their corresponding supported web browsers.

Operating System and Supported Web Browsers

OPERATING SYSTEM	SUPPORTED WEB BROWSERS
Windows® operating system	Chrome™ web browser, version 31 and later Firefox® web browser, version 31 and later Internet Explorer web browser, version 11 and later Microsoft Edge web browser
macOS® operating system	Safari® web browser, version 6 and later Chrome web browser, version 31 and later Firefox web browser, version 31 and later

Access the Web Interface with a Web Browser

1. Enter the IP address of the DM-NAX-4ZSA-50 into a web browser.

NOTE: To obtain the IP address, use the **Device Discovery Tool** option in Crestron Toolbox™ application or an IP scanner application.

2. If you are creating a user account for the first time, do the following; otherwise, skip to step 3.
 - a. Enter a username in the **Username** field.
 - b. Enter a password in the **Password** field.
 - c. Re-enter the same password in the **Confirm Password** field.

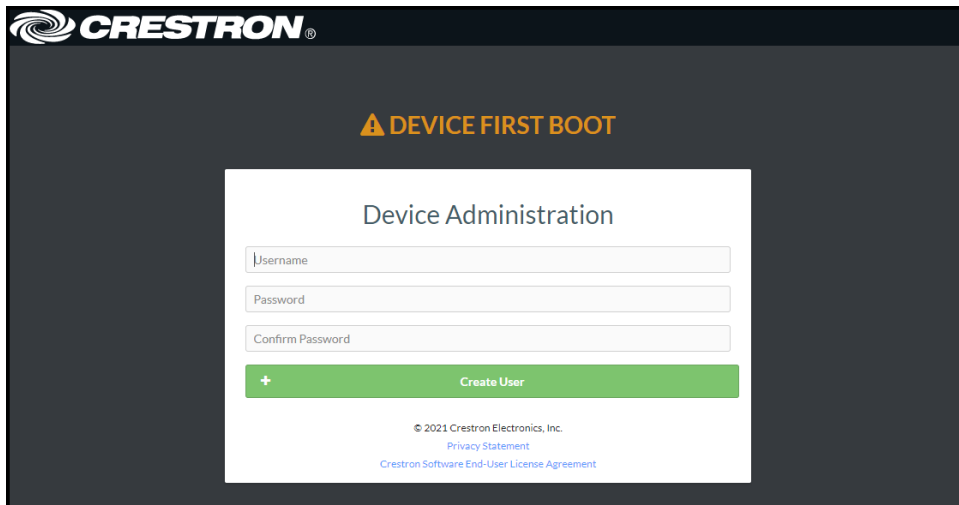

The screenshot shows the Crestron logo at the top left. Below it, a warning icon and the text "DEVICE FIRST BOOT" are displayed. The main content is a white box titled "Device Administration" containing three input fields: "Username", "Password", and "Confirm Password". Below these fields is a green button with a plus sign and the text "Create User". At the bottom of the white box, there is copyright information: "© 2021 Crestron Electronics, Inc.", "Privacy Statement", and "Crestron Software End-User License Agreement".

- d. Select **Create User**. The Device Administration page appears.

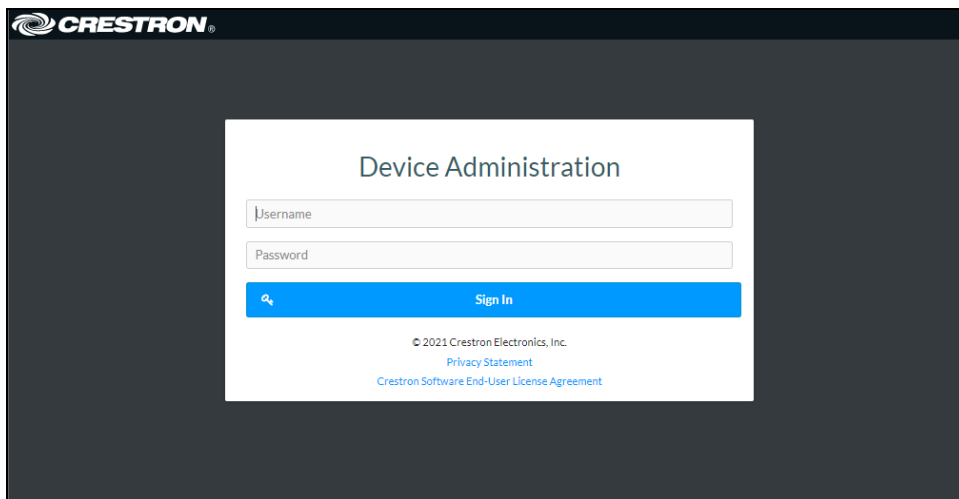

The screenshot shows the Crestron logo at the top left. Below it, the text "DEVICE FIRST BOOT" is no longer present. The main content is a white box titled "Device Administration" containing two input fields: "Username" and "Password". Below these fields is a blue button with a magnifying glass icon and the text "Sign In". At the bottom of the white box, there is copyright information: "© 2021 Crestron Electronics, Inc.", "Privacy Statement", and "Crestron Software End-User License Agreement".

3. Enter the username in the **Username** field.
4. Enter the password in the **Password** field.
5. Select **Sign In**.

Access the Web Interface With the Crestron Toolbox™ Application

To access the web interface by opening a web browser from the Crestron Toolbox™ application:

1. Open the Crestron Toolbox application.
2. From the **Tools** menu, select **Device Discovery Tool**. You can also access the Device Discovery Tool by selecting the Device Discovery Tool icon  in the Crestron Toolbox toolbar. The DM-NAX-4ZSA-50 is discovered and listed in the device list on the left side of the screen. The associated host name, IP address, and firmware version are also displayed.

NOTE: If there is security software running on the computer, a security alert might be displayed when the Crestron Toolbox application attempts to connect to the network. Make sure to allow the connection, so that the Device Discovery Tool can be used.

3. In the Device Discovery Tool list, select the device.
4. Enter the device credentials in the **Authentication Required** dialog that opens, then select **Log In**.
5. Select **Web Configuration**.

Action

The **Action** drop-down menu is displayed at the top right side of the interface and provides quick access to common device functions:

- [Save Changes on page 251](#)
- [Revert on page 251](#)
- [Reboot on page 252](#)
- [Restore to Factory Default Settings on page 252](#)
- [Update Firmware on page 252](#)
- [Download Logs on page 253](#)
- [Manage Certificates on page 253](#)
- [Manage Audio Profiles on page 255](#)
- [Download Configuration on page 256](#)
- [Download Configuration on page 256](#)

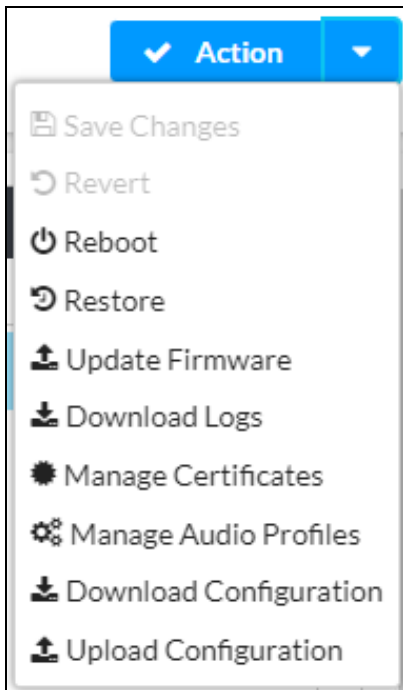

Save Changes

Select **Save Changes** to save any changes made to the configuration settings.

Revert

Select **Revert** to revert the device back to the last saved configuration settings.

Reboot

Certain changes to the settings may require the DM-NAX-4ZSA-50 to be rebooted to take effect. To reboot the device:

1. Select **Reboot** in the **Action** drop-down menu. The **Confirmation** message box appears.

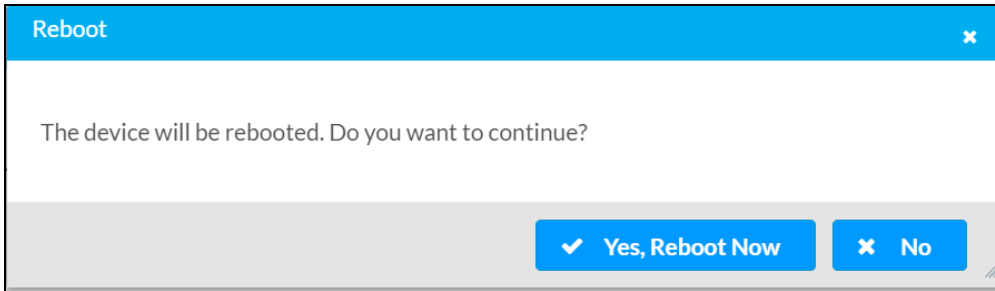

2. Select **Yes, Reboot Now** to reboot the device. The **Reboot** message box appears. Wait for the device reboot to complete before attempting to reconnect to the device.

Restore to Factory Default Settings

1. Select **Restore** in the **Action** drop-down menu to restore the settings of the DM-NAX-4ZSA-50 to factory defaults.

NOTE: When settings are restored, all settings, including the network settings, will revert to the factory default. If a static IP address is set, restoring the device to factory default settings will revert the IP address to the default DHCP mode.

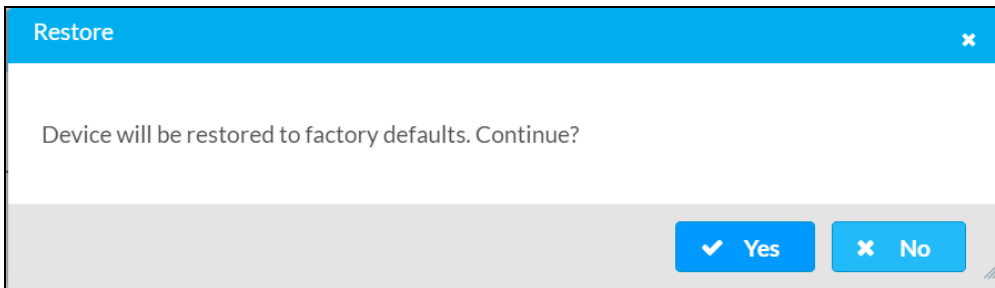

2. Select **Yes** in the **Confirmation** dialog to restore the DM-NAX-4ZSA-50 to factory settings. Select **No** to cancel the restore operation.

A dialog is displayed again, indicating that the restore process was successful and that the device rebooted.

You can also restore to factory settings by pressing and holding the **SETUP** button on the rear panel of the device with power disconnected then connect the power supply and continue to hold **SETUP** button for 30 seconds.

Update Firmware

1. Select **Update Firmware** in the **Action** drop-down menu.
2. In the **Firmware Upgrade** dialog, select **+ Browse**.

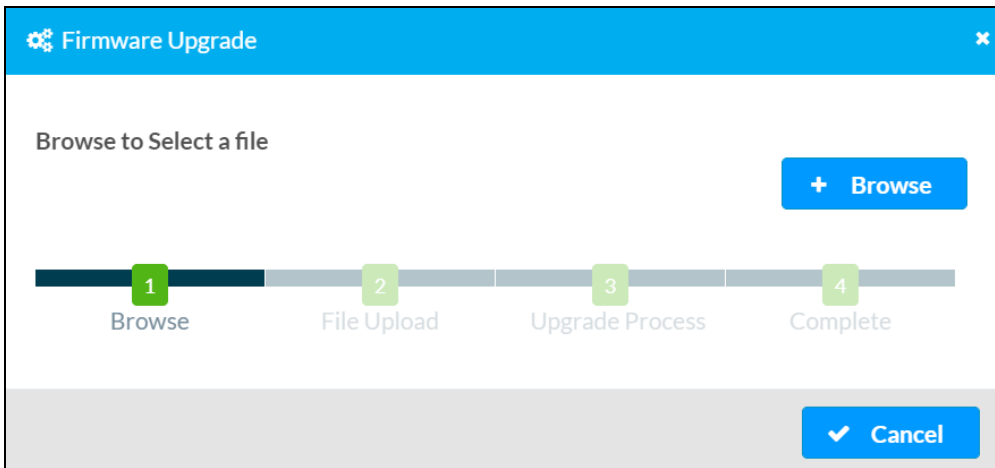

3. Locate and select the desired firmware file, then select **Open**. The selected firmware file name is displayed in the **Firmware Upgrade** dialog.
4. Select **Load** and wait for the progress bar to complete and for **OK** to become selectable.
5. Select **OK**. The device with new firmware can now be accessed.

Download Logs

Select **Download Logs** in the **Action** drop-down menu to download the device message logs for diagnostic purposes.

The log file is downloaded to the Downloads folder of the PC.

Manage Certificates

Use the **Manage Certificates** dialog to add, remove, and manage certificates used in 802.1x and other protected networks.

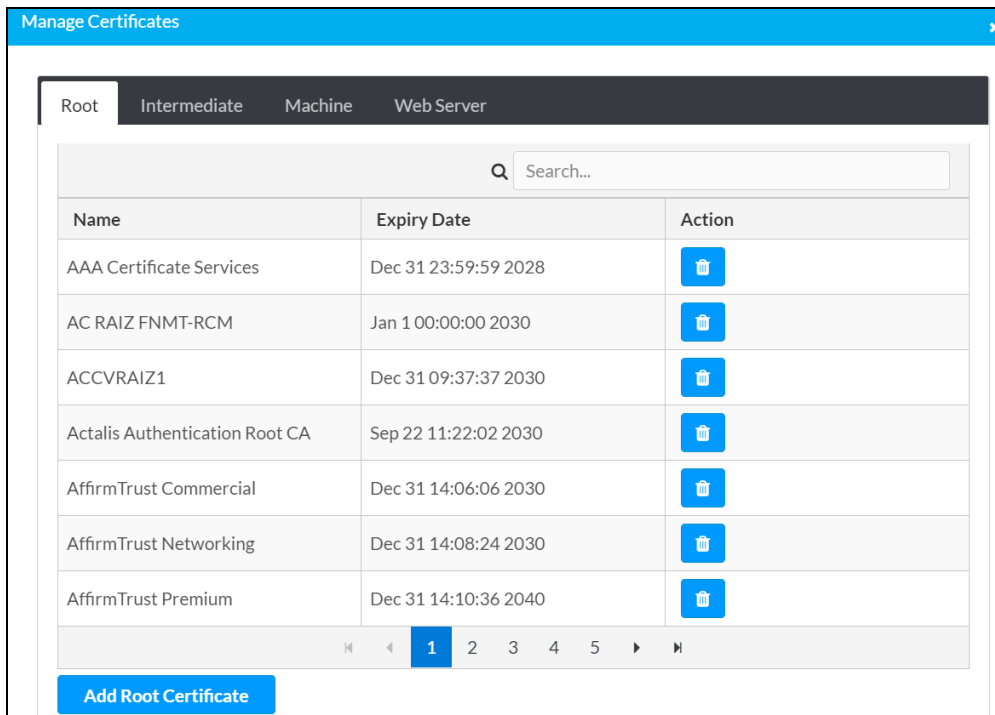

Select **Manage Certificates** in the **Action** drop-down menu. The following certificate tabs are displayed:

- **Root:** The Root certificate is used by the DM-NAX-4ZSA-50 to validate the network's authentication server. The DM-NAX-4ZSA-50 has a variety of Root certificates, self-signed by trusted CAs (Certificate Authorities) preloaded into the device. Root certificates must be self-signed.
- **Intermediate:** The Intermediate store holds non self-signed certificates that are used to validate the authentication server. These certificates will be provided by the network administrator if the network does not use self-signed Root certificates.
- **Machine:** The machine certificate is an encrypted PFX file that is used by the authentication server to validate the identity of the DM-NAX-4ZSA-50. The machine certificate will be provided by the network administrator, along with the certificate password. For 802.1x, only one machine certificate can reside on the device.
- **Web Server:** The Web Server certificate is a digital file that contains information about the identity of the web server.

To Add Certificates

1. Select the corresponding certificate tab.
2. Select **Add Root Certificate**.
3. Select **+ Browse**.
4. Locate and select the file, and then select **Open**.

NOTE: If the certificate is a Machine Certificate, enter the password provided by the network administrator.

5. Select **OK**. This will add the certificate to the list box, displaying the file name and expiration date. The certificate is now available for selection and can be loaded to the device.

To Delete Certificates

1. Select the corresponding certificate tab.
2. Select the trashcan icon  in the **Actions** column to delete the certificate.
3. Select **Yes** when prompted to delete the certificate or **No** to cancel the deletion.

Manage Audio Profiles

Use the **Manage Audio Profiles** dialog to add, remove, and manage the audio profiles of speakers.

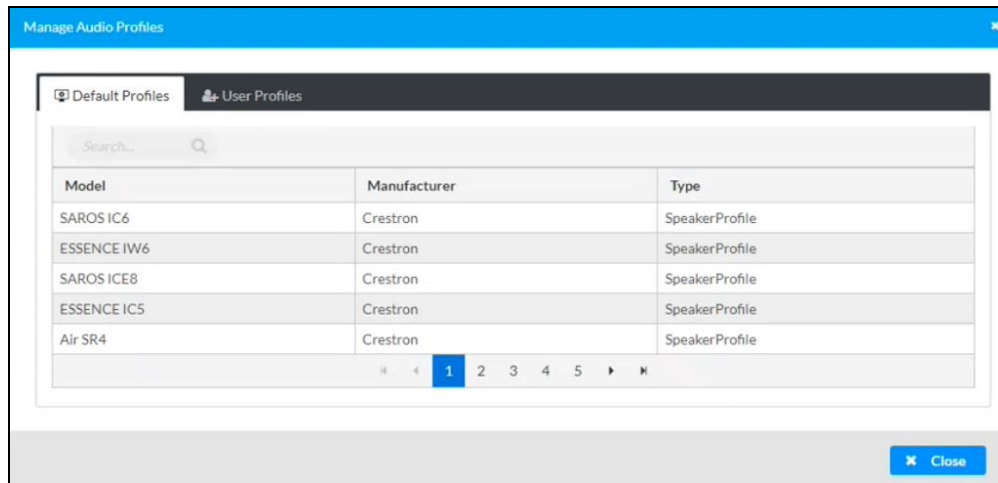

Select **Manage Audio Profiles** in the **Action** drop-down menu. The following audio profiles tabs are displayed, providing information such as **Model**, **Manufacturer**, and **Type** of the speaker profiles:

- **Default Profiles:** Lists the default library of included speaker profiles.
- **User Profiles:** Lists the custom, user loaded profiles, and allows them to be loaded and removed.

In the **Search** field, enter the speaker's profile name to search for the profile. The speaker profile matching the search criteria is displayed.

NOTE: To create a custom speaker profile, see [Online Help Article 1001820](#).

To Add a Speaker Profile

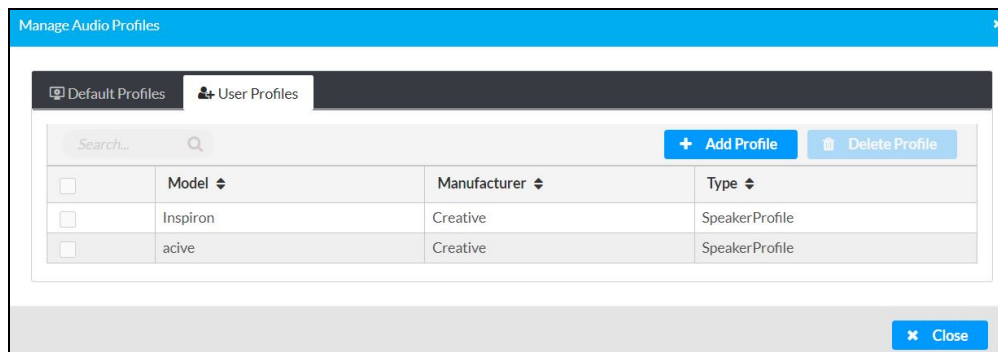

1. Select the **User Profiles** tab.
2. Select **+ Add Profiles**.
3. Select **+ Browse**.
4. Locate and select the .prof file, then select **Open**.
5. Select **Upload**.

6. Select **OK**. This will add the profile to the list box.

The speaker profile is now available for selection and can be applied to the speaker.

To Delete a Speaker Profile

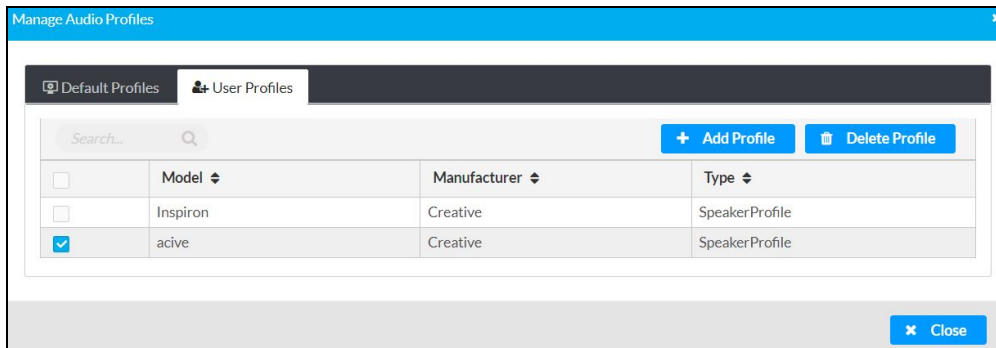

1. Select the **User Profiles** tab.
2. Select the checkbox corresponding to the audio profile that needs to be deleted.
3. Select **Delete Profile**.

The speaker profile is deleted.

Download Configuration

Select **Download Configuration** to download a TGZ file containing the settings data for the DM NAX device.

NOTE: User accounts for accessing the device, streaming service accounts, multicast addresses, and stream names are not saved in this configuration file.

Upload Configuration

1. Select **Upload Configuration** to upload a TGZ file that will overwrite the current settings of the DM NAX device with a saved configuration.

CAUTION: Be sure to load a TGZ file for the same DM NAX device type while using the Load Configuration feature. For example, if loading a TGZ file to a DM-NAX-4ZSA-50, be sure that the TGZ file originated from a DM-NAX-4ZSA-50.

2. Select **Browse** to navigate to the desired TGZ file in your file browser. Select the file, then select **Open**.

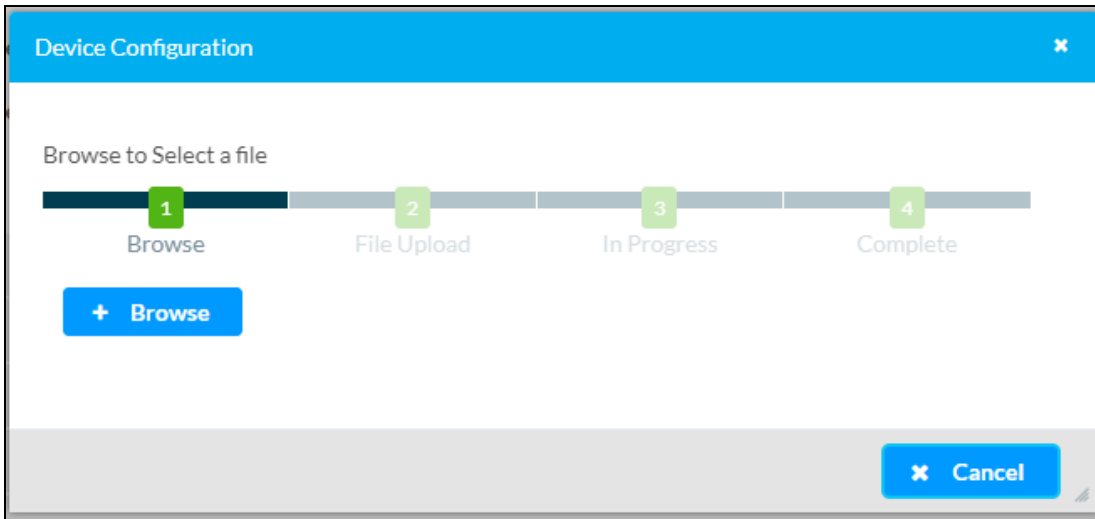

3. Select **Upload** to begin the file upload process. A progress bar will indicate the status of the configuration file upload.
4. Once the upload is complete, the device will require a reboot. Select **Yes, Reboot Now** to begin the reboot, or select **No** to return to the web UI.

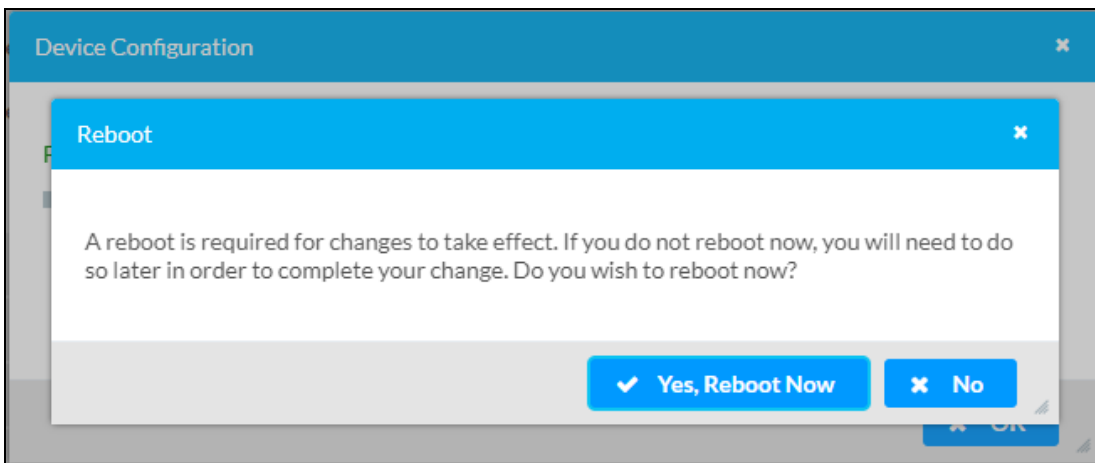

NOTE: Any changes made after the configuration file upload, but before a device reboot, may be overwritten when the device is rebooted.

Status

The **Status** page is the first page displayed when opening the interface of the DM-NAX-4ZSA-50. It displays general information about the DM-NAX-4ZSA-50 (such as **Model Name**, **Firmware Version**, and **Serial Number**), current network settings (such as Host Name and IP Address, etc.), and input and output ports' current status.

The **Status** page can be accessed at any time by selecting the **Status** tab of the DM-NAX-4ZSA-50 interface.

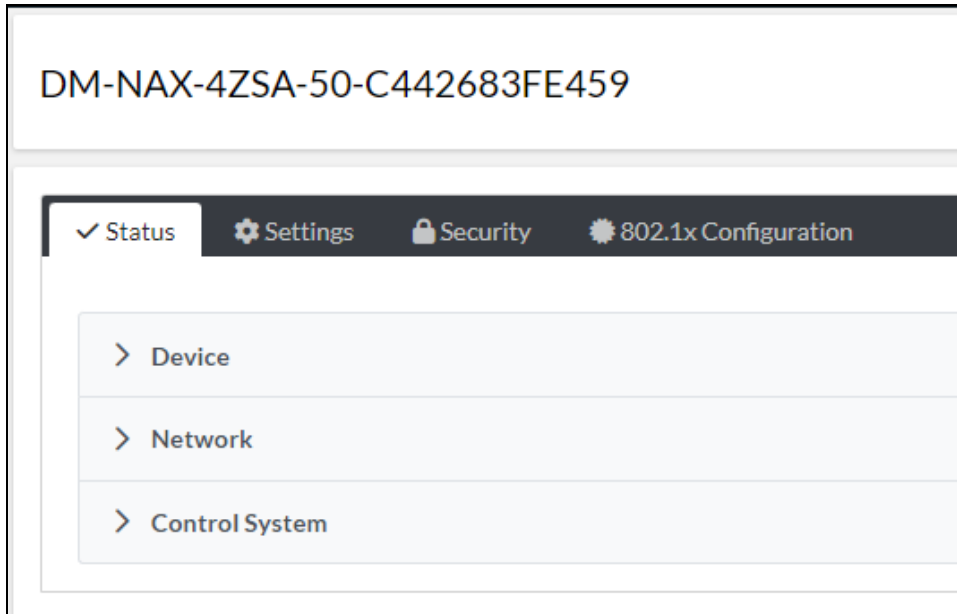

Information displayed on the **Status** tab is organized into different sections.

Device

The **Device** section displays the **Model**, **Firmware Version**, and **Serial Number** of the DM-NAX-4ZSA-50.

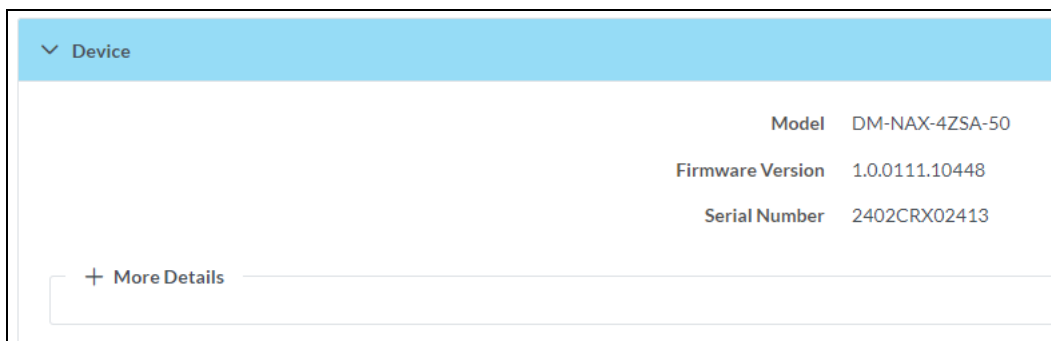

Select **+ More Details** to review additional information about the DM-NAX-4ZSA-50.

More Details	
DM-NAX-4ZSA-50	1.0.0111.10448
Build	Feb 16 2024 (531614)
Updater	1.0.0111.10448
Bootloader	02.019.000
CCUI Version	1.1338.557
XIOSDK	3.8.2
IoTSDK	1.10.1
Build time	10:44:52
Product ID	0x7A04
Revision ID	0x0300
HDCP2X-SKE	HDCP2X-SKE [v9.0000.00000.#FFFFFFFF]
PRE-BOOT	[v9.0000.00000]
BOOTLOADER	[v9.0000.00000]
amp0-fpga-4zsa	FW v551.39 Rev.17 (Driver v1.1)
ctrl-audio-dsp-0	FW v19 (Driver v4.00)
ctrl-prod-info	Driver v3.0
PUF	1.0.0111.10448
Forced Auth Mode	True

Network

The **Network** section displays network-related information about the DM-NAX-4ZSA-50, including the Hostname, Domain Name, and DNS Servers.

Network	
Hostname	DM-NAX-4ZSA-50-C442683FE459
Domain Name	6vcrestronqelab.com
DNS Servers	10.253.31.12(DHCP)
Adapter 1	
DHCP	On
IP Address	10.253.38.72
Subnet Mask	255.255.255.0
Default Gateway	10.253.38.1
Link Active	true
MAC Address	c4.42.68.3f.e4.59

NOTE: By default, the host name of the DM-NAX-4ZSA-50 consists of the model name followed by the MAC address of the device. For example, DM-NAX-4ZSA-50-00107FB58088.

Select **+ Adapter 1** to display an expanded section that shows additional information. If **+ Adapter 1** is selected, select **- Adapter 1** to collapse the section.

NOTE: The **+ Adapter 2** option appears when the dual Ethernet ports on the DM-NAX-4ZSA-50 are set to isolate traffic using the **Port Selection** feature. Refer to [Settings on page 261](#) for details on configuring the **Port Selection** feature.

Control System

The **Control System** section displays connection information, consisting of the following:

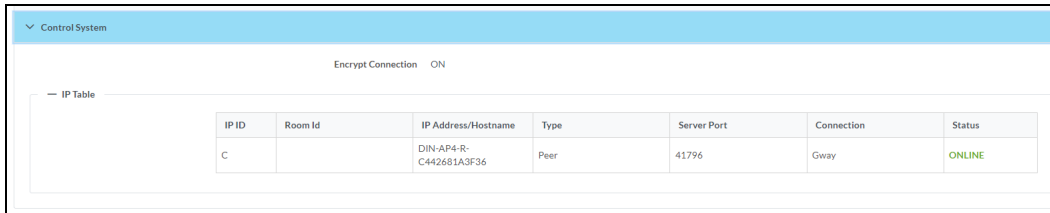

The screenshot shows a web interface for the Control System. At the top, there is a toggle for 'Encrypt Connection' set to 'ON'. Below this is a section titled 'IP Table' containing a table with the following data:

IP ID	Room Id	IP Address/Hostname	Type	Server Port	Connection	Status
C		DIN-AP4-R- C442681A3F36	Peer	41796	Gway	ONLINE

- **Encrypt Connection:** ON or OFF
- **IP ID:** Reports the currently used IP ID of the DM-NAX-4ZSA-50
- **IP Address/Hostname:** The IP address of the control system
- **Room ID:** Displays the room ID
- **Status:** OFFLINE or ONLINE

Settings

The **Settings** page enables you to configure the DM-NAX-4ZSA-50 settings. The **Settings** page can be accessed at any time by selecting the **Settings** tab of the DM-NAX-4ZSA-50 interface.

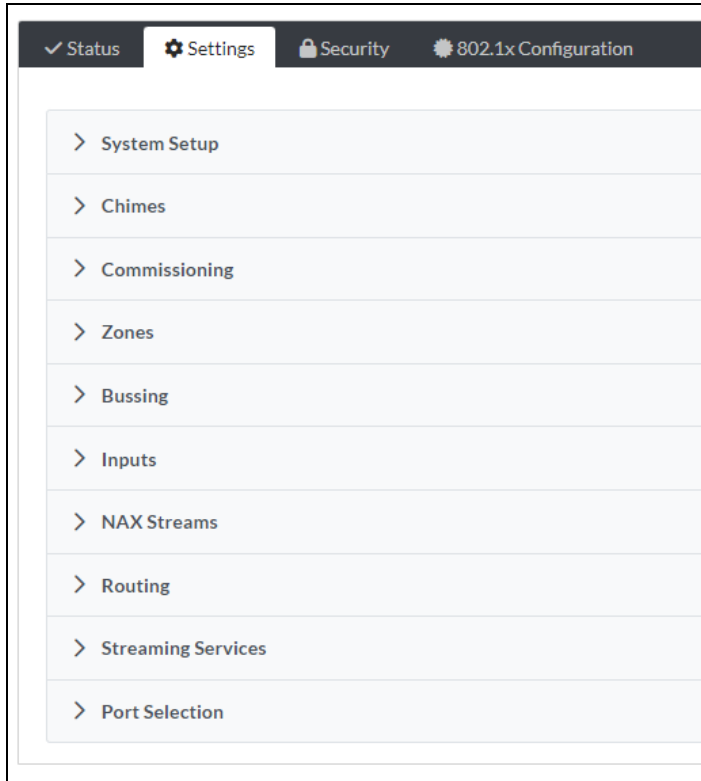

Settings available on the **Settings** tab are organized into different sections.

System Setup

The **System Setup** section contains settings for **Date/Time**, **Auto Update**, **Network**, and **Control System**.

Date/Time

Use the **Date/Time** section to configure the date and time settings of the DM-NAX-4ZSA-50.

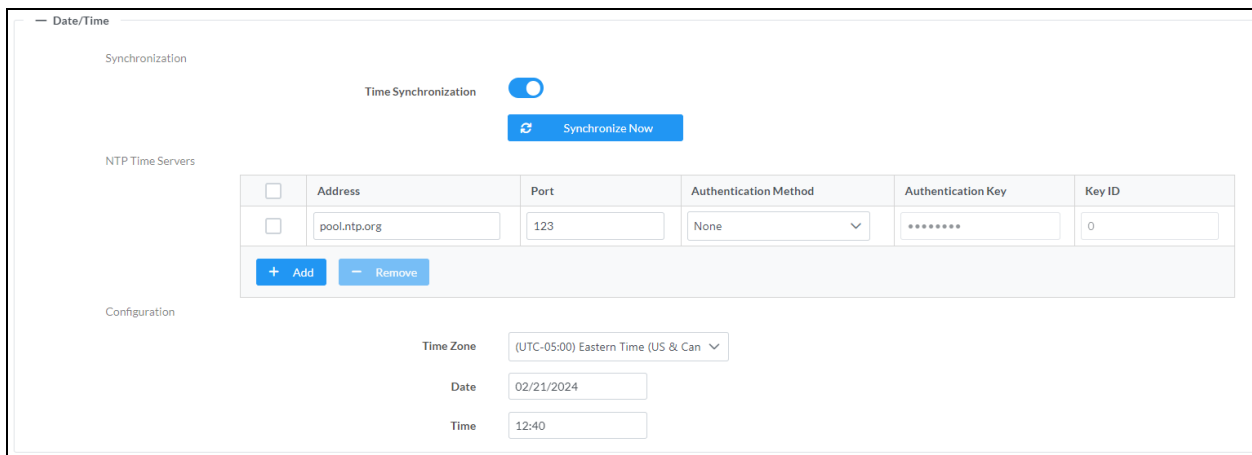

Time Synchronization

1. Set the **Time Synchronization** toggle to the right position to enable or left position to disable time synchronization. By default, time synchronization is enabled.
2. In the **NTP Time Servers** table, enter the URL of a NTP (Network Time Protocol) or SNTP (Simple Network Time Protocol) server. Up to three time servers can be added on a device.
3. Select **Synchronize Now** to perform time synchronization between the device's internal clock and the time server.

Time Configuration

1. Open the **Time Zone** drop-down menu to select the applicable time zone.
2. In the **Date** field, enter the current date.
3. In the **Time (24hr Format)** field, enter the current time in 24-hour format.

Select **Save Changes** to save the settings.

Select **Revert** from the **Action** drop-down menu to revert to the previous settings without saving.

Auto Update

The DM-NAX-4ZSA-50 can automatically check for and install firmware updates at scheduled intervals via the Auto Update feature.

Auto Update

Schedule

Auto Update

Custom URL

Custom URL Path

Day of Week

Time of Day

Poll Interval Minutes

Update Now

1. Set the **Auto Update** toggle to the right position to enable Auto Update.
2. Define the URL to download the updates by doing either of the following:
 - a. Use the default URL to download the updates from the Crestron server.
 - b. Use a custom URL. Set the **Custom URL** toggle to the right position to enable a custom URL. In the **Custom URL Path** text box, enter the path to a custom manifest file in the FTP or SFTP URL format. Use the Crestron Auto Update Tool to generate a custom manifest file, then store the file on an FTP (File Transfer Protocol) or SFTP (Secure File Transfer Protocol) server.
3. Set a schedule for the automatic firmware update by doing either of the following:

- a. Select the desired **Day of Week** and **Time of Day** (24-hour format) values.
 - b. Set the **Poll Interval** by entering a value from **60** to **65535** minutes. A value of **0** disables the Poll Interval.
4. Select **Save Changes**.

Selecting **Update Now** causes the device to check for a firmware update immediately. If a schedule was set in step 4 above, that schedule still remains in effect.

Network

The **Network** section contains network-related settings for the DM-NAX-4ZSA-50, including the Hostname, Domain, Primary Static DNS, and Secondary Static DNS.

The screenshot shows the Network configuration interface for Adapter 1. The settings are as follows:

Field	Value
Hostname *	DM-NAX-4ZSA-50-C442683FE459
Domain	6vcrestronqelab.com
Primary Static DNS	10.253.31.12(DHCP)
Secondary Static DNS	
DHCP Enabled	<input checked="" type="checkbox"/>
IP Address	10.253.38.72
Subnet Mask	255.255.255.0
Default Gateway	10.253.38.1

NOTE: By default, the hostname of the DM-NAX-4ZSA-50 consists of the model name followed by the MAC address of the device. For example, DM-NAX-4ZSA-50-00107FB58088.

Adapter 1

The **Adapter 1** subheading contains settings for **DHCP**, **IP Address**, **Subnet Mask**, and **Default Gateway** of Ethernet adapter 1 on the rear panel of the device.

NOTES:

- An **+ Adapter 2** option only appears when the dual Ethernet ports on the DM-NAX-4ZSA-50 are set to isolate traffic using the **Port Selection** feature. The settings for **Adapter 2** are identical to those available for **Adapter 1**.
- DM NAX devices' internal processes use IP addresses in the 10.10.10.xxx range. This IP range should be avoided when addressing DM NAX devices to prevent conflicts.

Set the **DHCP** toggle to enabled (right) or disabled (left) to specify whether the IP address of the DM-NAX-4ZSA-50 is to be assigned by a DHCP (Dynamic Host Configuration Protocol) server.

- **Enabled:** When DHCP is enabled (default setting), the IP address of the DM-NAX-4ZSA-50 is automatically assigned by a DHCP server on the local area network (LAN).
- **Disabled:** When DHCP is disabled, manually enter information in the following fields:
 - **Primary Static DNS:** Enter a primary DNS IP address.
 - **Secondary Static DNS:** Enter a secondary DNS IP address.
 - **IP Address:** Enter a unique IP address for the DM-NAX-4ZSA-50.
 - **Subnet Mask:** Enter the subnet mask that is set on the network.
 - **Default Gateway:** Enter the IP address that is to be used as the network's gateway.

To save any new network entries, select **Save Changes**.

Control System

Control System Username: chdevice

Control System Password: *****

Encrypt Connection

IP Table

<input type="checkbox"/>	IP ID	IP Address/Hostname	Room Id
<input type="checkbox"/>	C	DIN-AP4-R-C442681A3F36	Room Id

+ Add x Remove

1. Select **Encrypt Connection** to navigate to the **Security** tab to configure encryption settings.
 - a. Enter the username in the **Control System Username** field.
 - b. Enter the password in the **Control System Password** field.
2. Select **+ Add** to add an IP table entry to the **IP Table**.
 - a. Enter the Room ID in the **Room ID** field.
 - b. Enter the IP ID of the DM-NAX-4ZSA-50 in the **IP ID** field.
 - c. Enter the IP address or hostname of the control system in the **IP Address/Hostname** field.
3. Select **Save Changes** to save the new entries. The **Control System Save** message box appears, indicating that the control system settings were saved successfully. Select **Revert** to revert to the previous settings without saving.

Commissioning

The **Commissioning** section provides a quick way to automatically assign multicast addresses to all of the device's internal audio-over-IP stream transmitters.

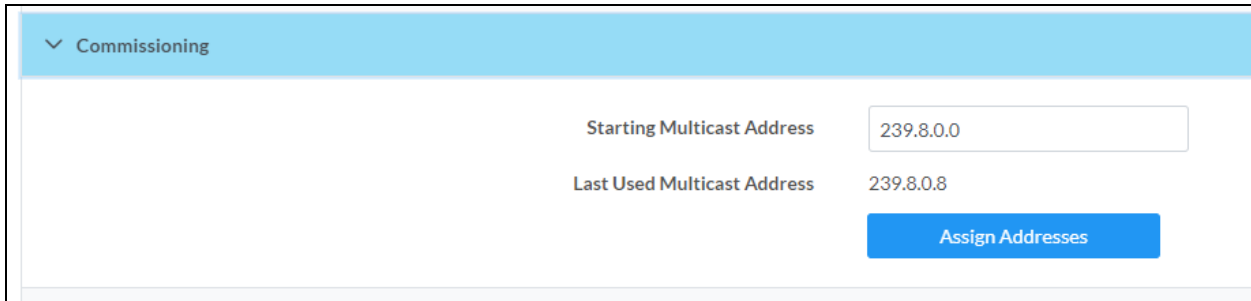

The screenshot shows a web interface for the 'Commissioning' section. At the top, there is a blue header with a dropdown arrow and the text 'Commissioning'. Below this, the interface is white. On the right side, there is a text input field containing '239.8.0.0' with the label 'Starting Multicast Address' to its left. Below that, the text '239.8.0.8' is displayed with the label 'Last Used Multicast Address' to its left. At the bottom right, there is a blue button with the text 'Assign Addresses'.

Select **Assign Addresses** to give each DM NAX transmitter in the DM-NAX-4ZSA-50 a unique multicast address beginning with the specified **Starting Multicast Address**. The valid range for **Starting Multicast Address** is 239.8.0.0 to 239.255.255.247.

NOTE: This will begin transmitting multicast traffic on your network. Refer to [Audio-over-IP Network Design on page 632](#) for details on proper audio-over-IP network management.

Chimes

The **Chimes** section allows the built-in chime files to be assigned to any of the output zones on the device.

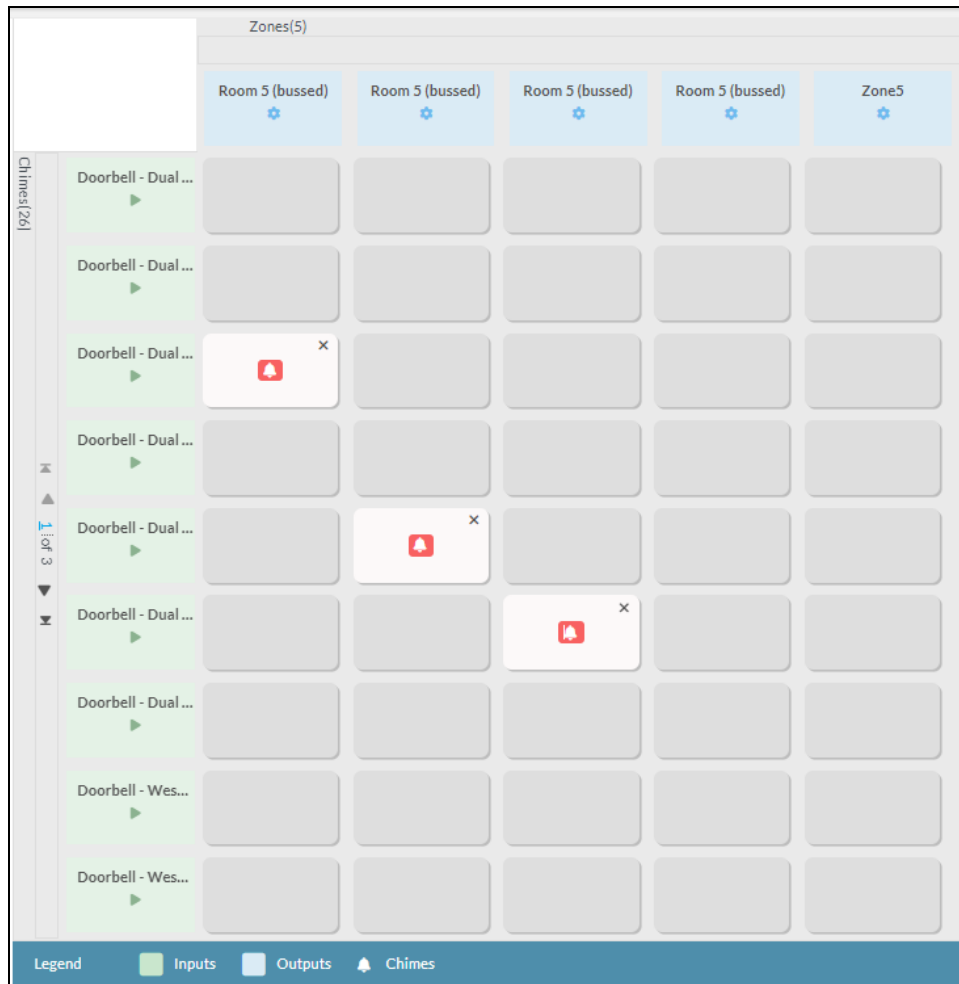

For each chime file, select the cells corresponding to the desired Zones for playback of that specific chime sound. You can assign multiple chimes to the same zone. To view all available chimes, use the ▲ or ▼ arrows at the left of the matrix to change pages.

To configure the chime volume of a zone:

1. Select the  icon corresponding to the zone. A **Configure** window appears.

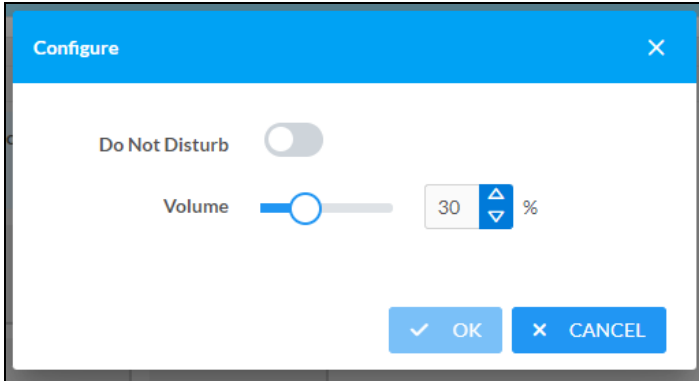

2. To set the volume, do one of the following:
 - Move the **Volume** slider to the right to increase or to the left to decrease the chime volume.
 - Use the **%** arrows to increase or decrease the chime volume. Values range from 0 to 100%, adjustable in increments of 1%.
 - Manually enter a value in the **Volume** field.

NOTE: The chime volume is independent of the zone volume control.

3. Set the **Do Not Disturb** toggle to the right to mute all chimes for the zone. Set the **Do Not Disturb** toggle to the left to unmute the chimes.
4. Select **OK** to apply the new settings.

Zones

The **Zones** section contains the **Volume** and **Mute** settings for all zone outputs of the device, as well as a Configure option for more advanced settings within each zone.

Name	Volume	Mute	Action
Room 5 (bussed)	0 %	Mute	Configure
Room 5 (bussed)	0 %	Mute	Configure
Room 5 (bussed)	0 %	Mute	Configure
Room 5 (bussed)	0 %	Mute	Configure
Zone5	30 %	Mute	Configure

Give each zone a friendly name using the **Name** column of the **Zones** table. If the device is paired with a control system, these names may be overwritten by the control system's program.

To configure the zone volume, do one of the following:

- Move the **Volume** slider to the right to increase or to the left to decrease the zone volume.
- Use the **%** arrows to increase or decrease the zone volume. Values range from 0 to 100%, adjustable in increments of 1%.
- Manually enter a value in the **Volume** field.

To mute all audio output from a zone, select its respective **Mute**. To unmute the zone, select **Muted**.

Zone Settings

To configure zone settings, select **Configure** ( **Configure**). The **Edit Zone** window appears.

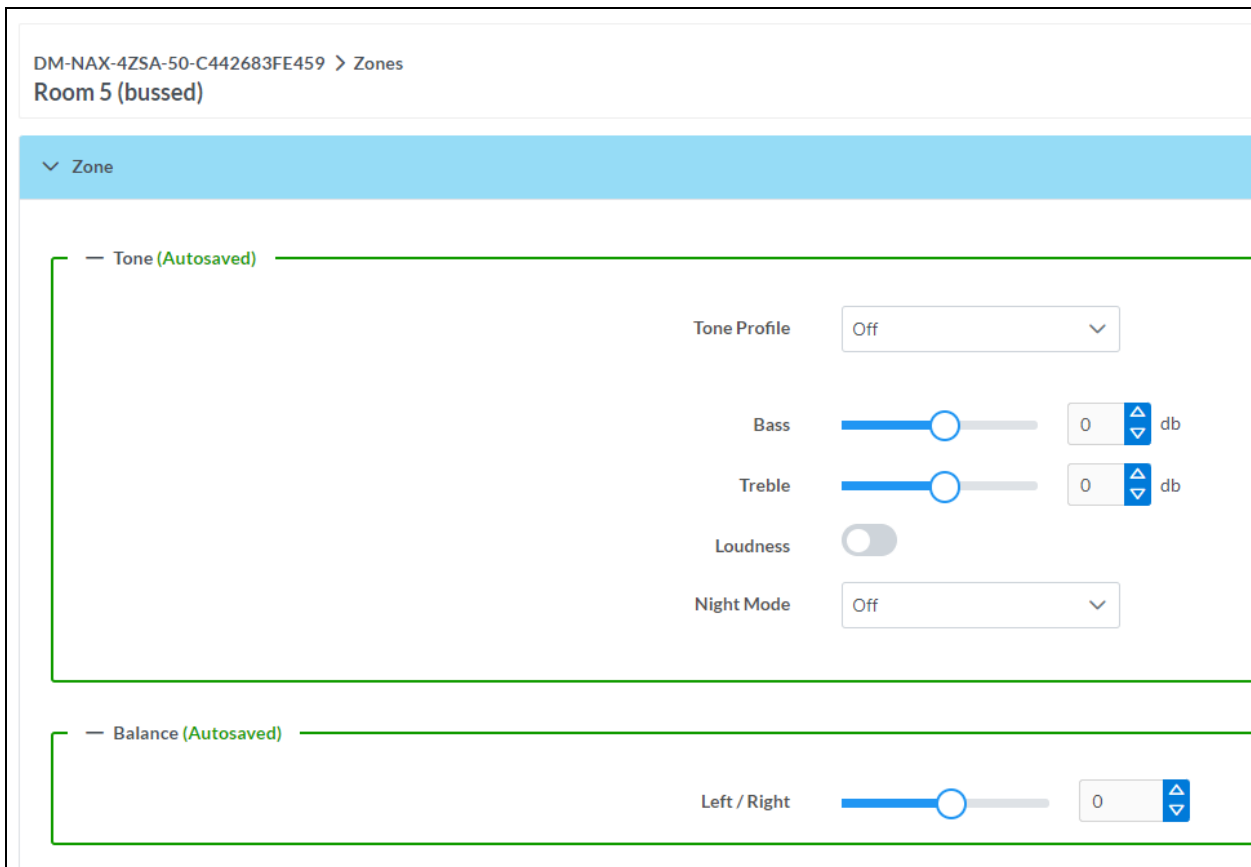

DM-NAX-4ZSA-50-C442683FE459 > Zones
Room 5 (bussed)

Zone

Tone (Autosaved)

Tone Profile: Off

Bass: 0 db

Treble: 0 db

Loudness: Off

Night Mode: Off

Balance (Autosaved)

Left / Right: 0

Zone

Select **Zone** to access the settings for **Tone**, **Balance**, and **Delay**.

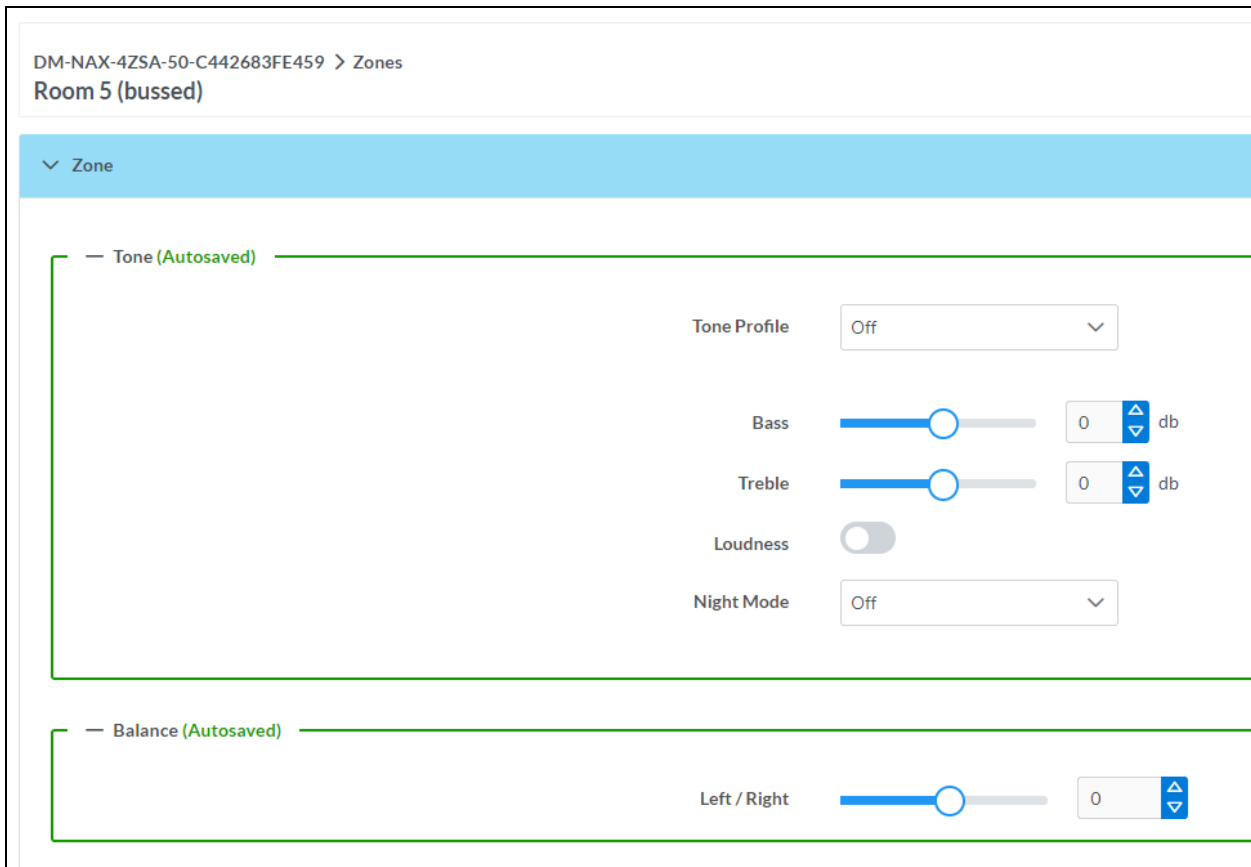

Tone

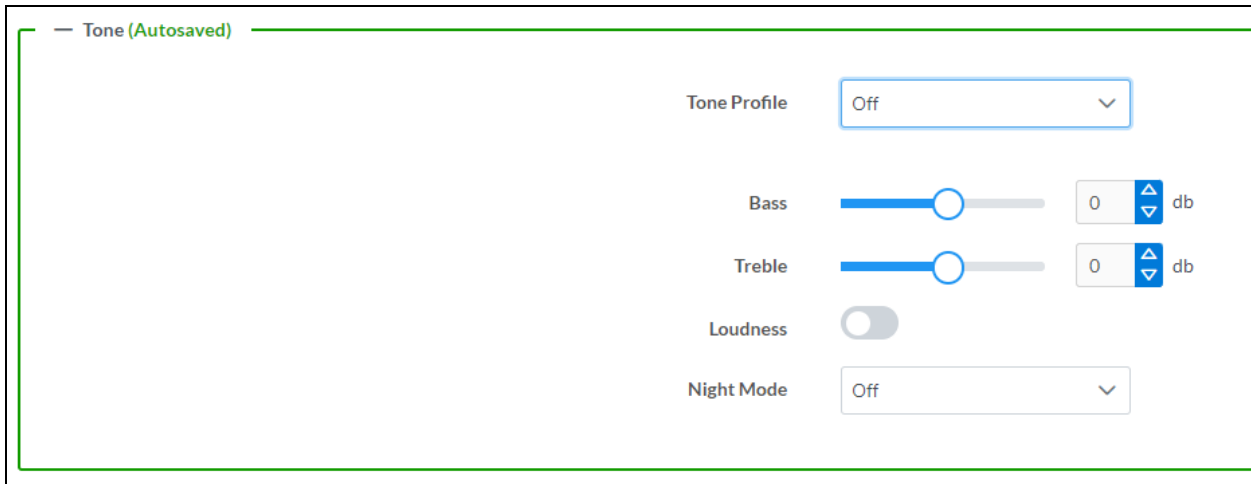

The **Tone** section provides adjustments for the **Tone Profile**, **Bass**, **Treble**, **Loudness**, and **Night Mode** settings of the zone output.

NOTE: The Tone Profile, Bass, Treble, and Loudness settings in the Tone section are all applied separately from the Equalizer Settings for the zone. This means that any adjustments made in the Tone section will stack with those made in the Equalizer Settings section.

1. To select a tone profile preset for the zone, select an option from the **Tone Profile** drop-down menu. The available options are **Off**, **Classical**, **Jazz**, **Pop**, **Rock**, and **Spoken Word**. By default, **Off** is selected.
2. **Bass**: To adjust the bass, do one of the following:
 - Move the **Bass** slider to the right to increase or to the left to decrease the bass.
 - Use the **db** arrows to increase or decrease the bass level. Values range from -12 dB to 12 dB, adjustable in increments of 1 dB.
 - Manually enter a value in the **Bass** field.
3. **Treble**: To adjust the treble, do one of the following:
 - Move the **Treble** slider to the right to increase or to the left to decrease the treble.
 - Use the **db** arrows to increase or decrease the treble level. Values range from -12 dB to 12 dB, adjustable in increments of 1 dB.
 - Manually enter a value in the **Treble** field.
4. To enable the loudness setting on the zone output, slide the **Loudness** switch to the right. To disable loudness, slide the **Loudness** switch to the left.
5. The **Night Mode** feature applies subtle processing to restrict the dynamic range of the zone audio, to allow for lower listening levels at night or in rooms where higher listening levels would be disruptive. To select a dynamics processing level, select an option from the **Night Mode** drop-down menu. The available options are **Off**, **Low**, **Medium**, and **High**. By default, **Off** is selected.

Balance



To adjust the left/right balance of the stereo output signal, do one of the following:

- Move the **Balance** slider to the right to shift the stereo balance to the right channel or to the left to shift the balance to the left.
- Use the arrows to adjust the balance left or right. The up arrow shifts the balance to the right while the down arrow shifts the balance to the left.
- Manually enter a value in the **Balance** field. Values range from -50 to 50, adjustable in increments of 1. Positive values shift the balance to the right while negative values shift the balance to the left.

Delay

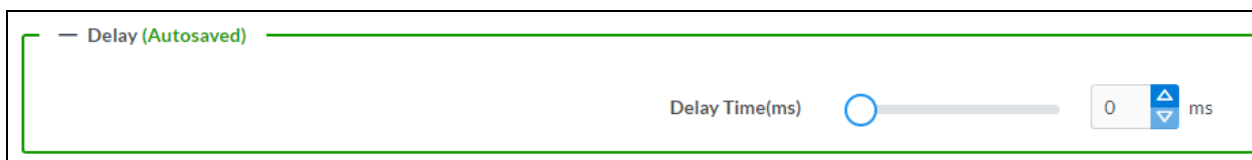

To set the delay, do one of the following:

- Move the **Delay Time(ms)** slider to the right to increase or to the left to decrease the delay time.
- Use the **ms** arrows to increase or decrease the delay. Values range from 0 ms to 250 ms, adjustable in increments of 1 ms.
- Manually enter a value in the **Delay Time(ms)** field.

Output

Select **Output** to access the settings for **Minimum/Maximum Volume, Stereo/Mono, Signal, Bussing Volume Offset, Configure Speaker Profile, Speaker Configuration, Casting, Speaker/Faults, Line Out, Signal Generator, Advanced Signal Generator, and Equalizer Settings.**

▼ Output

— Minimum / Maximum (Autosaved)

Minimum	<input type="range" value="0"/>	0	▲ ▼	%
Maximum	<input type="range" value="100"/>	100	▲ ▼	%
Default	<input type="range" value="30"/>	30	▲ ▼	%

— Stereo / Mono (Autosaved)

Stereo / Mono Stereo
 Mono

— Signal (Autosaved)

Signal Not Present

Minimum/Maximum Volume

— Minimum / Maximum (Autosaved)

Minimum	<input type="range" value="0"/>	0	▲ ▼	%
Maximum	<input type="range" value="100"/>	100	▲ ▼	%
Default	<input type="range" value="30"/>	30	▲ ▼	%

1. To set the minimum volume of the zone, do one of the following:
 - Move the **Minimum** slider to the right to increase or to the left to decrease the minimum volume.
 - Use the **%** arrows to increase or decrease the minimum volume. Values range from 0 to 50%, adjustable in increments of 1%.
 - Manually enter a value in the **Minimum** field.
2. To set the maximum volume of the zone, do one of the following:
 - Move the **Maximum** slider to the right to increase or to the left to decrease the maximum volume.
 - Use the **%** arrows to increase or decrease the maximum volume. Values range from 70 to 100%, adjustable in increments of 1%.
 - Manually enter a value in the **Maximum** field.

NOTE: When a **Minimum** and **Maximum** volume are set, the 1-100% range represented by the **Zone** and **Default** volume controls are scaled to the range set. For example, if a **Minimum** of 10% and a **Maximum** of 80% are set for a zone, the 1-100% range of the **Zone** volume control is scaled to the 10%-80% range set as the **Minimum** and **Maximum**.

3. To set the default volume of the zone, do one of the following:
 - Move the **Default** slider to the right to increase or to the left to decrease the default volume.
 - Use the **%** arrows to increase or decrease the default volume. Values range from 0 to 50%, adjustable in increments of 1%.
 - Manually enter a value in the **Default** field.

NOTE: The **Default** volume is applied as the **Zone** volume any time the zone receives a source route and no source was previously routed to that zone.

Stereo/Mono

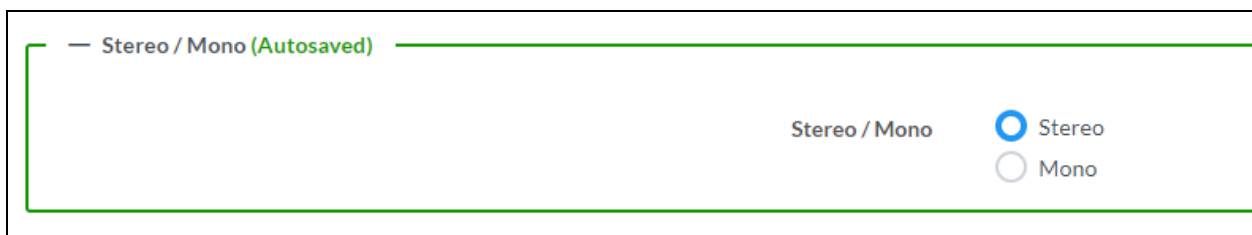

1. Select either **Stereo** or **Mono** from the **Stereo/Mono** field.

Stereo

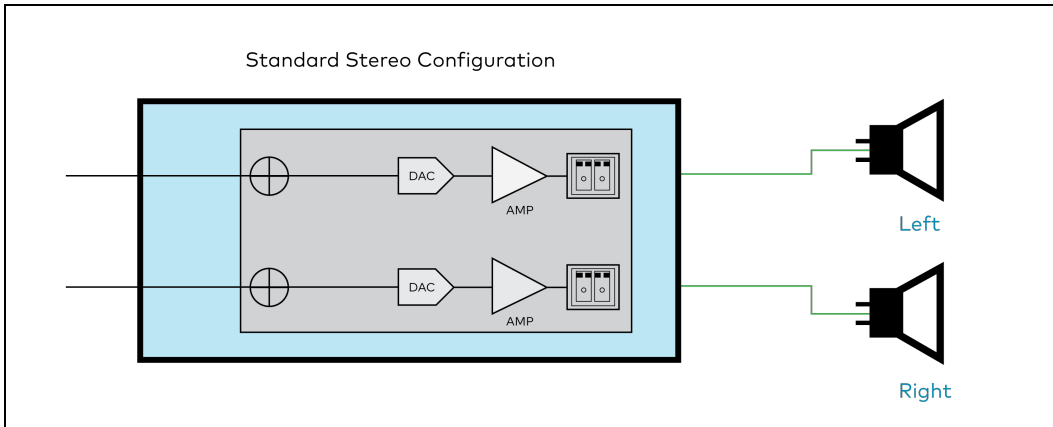

Mono

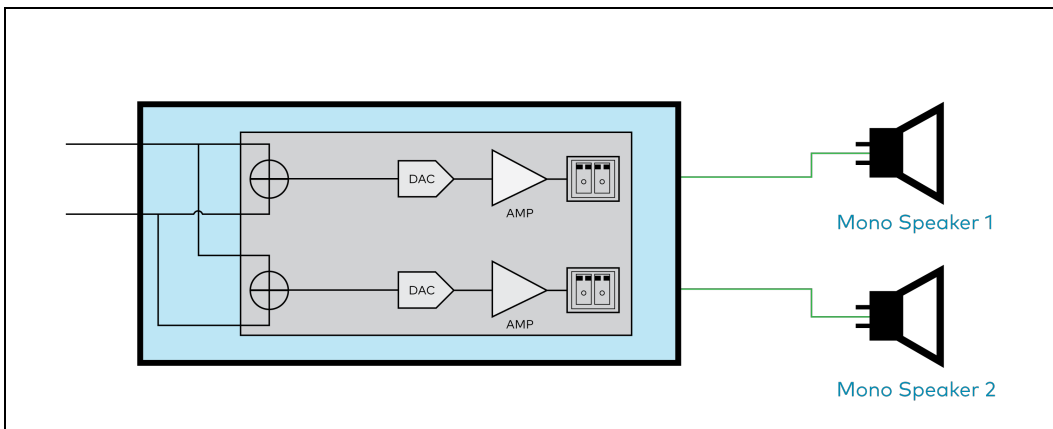

NOTE: The signal flow diagrams above are specifically for the speaker output zones (Zones 1 through 4). The diagrams still apply for Zone 5 with the exception of the amplifiers shown in the path of each output channel.

Signal

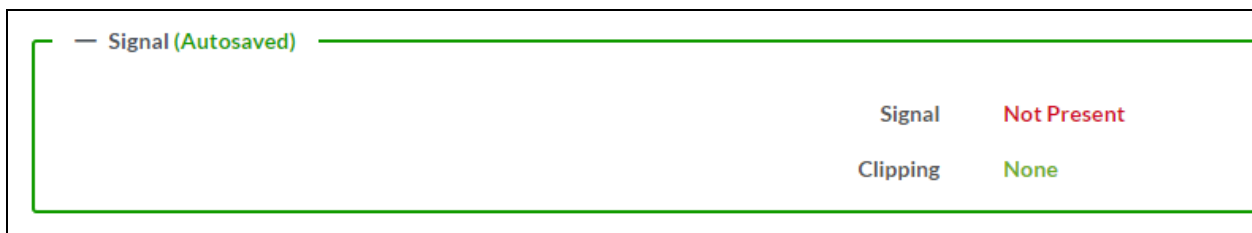

The **Signal** section is a read-only field that displays the **Signal** and **Clipping** status of the zone output.

- If an output signal is present but not clipping, **Signal** will display **Present** in green and **Clipping** will display **None** in green.

- If an output signal is present and clipping, **Signal** will display **Present** in green and **Clipping** will display **Present** in red.
- If no output signal is detected, **Signal** will display **Not Present** in red and **Clipping** will display **None** in green.

Bussing Volume Offset

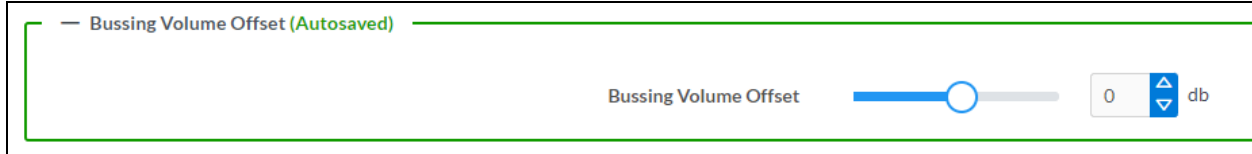

Bussing Volume Offset is an additional level compensation applied to the zone relative to any other zones it is grouped with via the **Bussing** feature.

To set the bussing volume offset, do one of the following:

- Move the **Bussing Volume Offset** slider to the right to increase or to the left to decrease the offset.
- Use the **db** arrows to increase or decrease the offset. Values range from -12 dB to 12 dB, adjustable in increments of 1 dB.
- Manually enter a value in the **Bussing Volume Offset** field.

Configure Speaker Profile

The DM-NAX-4ZSA-50 has a library of built-in speaker profiles that contain equalizer, speaker protection, and impedance settings specific to Crestron and third-party speaker models. Custom speaker profiles can also be generated and loaded to the DM-NAX-4ZSA-50. The **Configure Speaker Profile** field is used to apply these speaker profiles to a given zone of the DM NAX device.

NOTE: Applying a speaker profile on a zone will overwrite the existing **Speaker Configuration** and **Equalizer** settings for that zone.

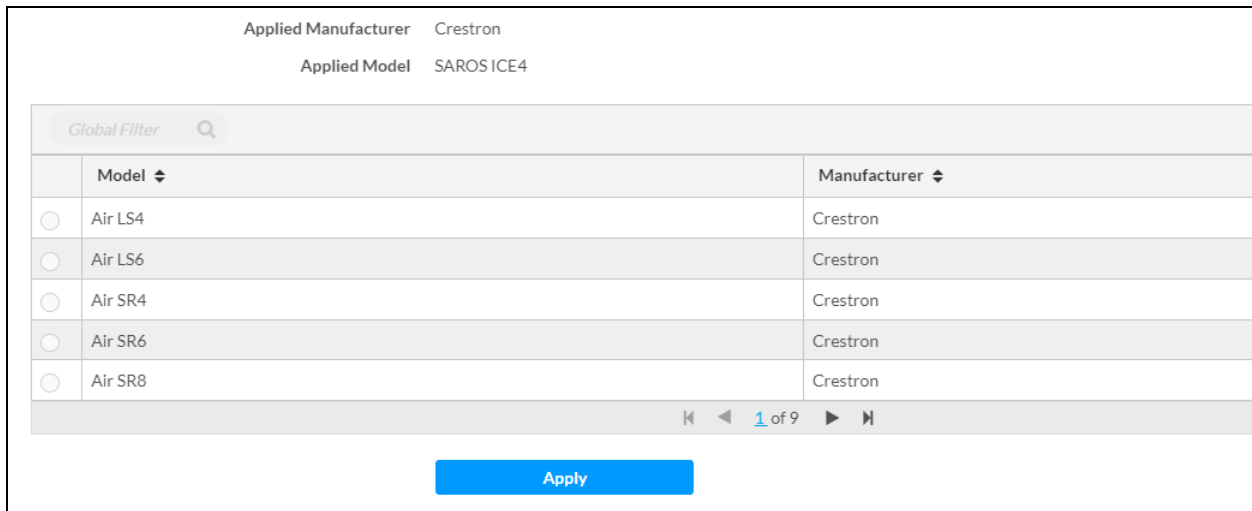

In the **Global Filter** field, enter the speaker's model name to search for its associated profile. Any speaker profiles matching the search criteria are displayed.

To apply a speaker profile:

1. Select a speaker profile.
2. Select **Apply**.

The equalizer, impedance, and speaker protection settings of the zone are updated as per the applied speaker profile.

NOTE: Zone 5 does not have impedance or speaker protection settings, but speaker profiles can still be applied to the zone output. Only the equalizer settings are effected when a speaker profile is applied to Zone 5.

After applying a speaker profile, the **Speaker Configuration** and **Equalizer** settings for the zone can still be edited. The **Configure Speaker Profile** section will display a notification if these settings were altered after the speaker profile was applied.

 Profile settings have been locally altered

Speaker Configuration (Zones 1 through 4 only)

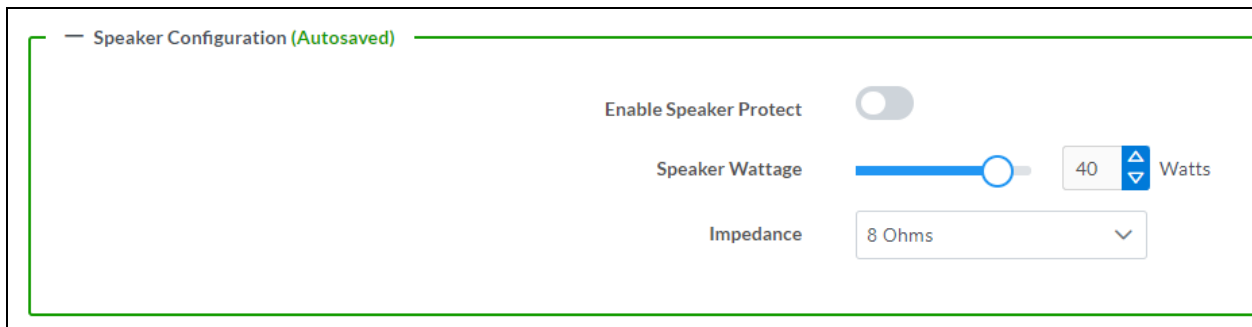

The screenshot shows the 'Speaker Configuration (Autosaved)' interface. It features three main settings:

- Enable Speaker Protect:** A toggle switch currently in the 'off' (left) position.
- Speaker Wattage:** A slider control set to 40 Watts, with up and down arrows for manual adjustment.
- Impedance:** A drop-down menu currently set to '8 Ohms'.

1. Set the **Enable Speaker Protect** toggle to the right position to enable speaker protection for the zone output. Set the toggle to the left position to disable speaker protection. By default, **Enable Speaker Protect** is set to the left position.
2. To set the maximum output wattage, do one of the following:
 - Move the **Speaker Wattage** slider to the right to increase or to the left to decrease the maximum peak amplifier wattage that can be output to the speaker.
 - Use the **Watts** arrows to increase or decrease the maximum peak amplifier wattage that can be output to the speaker. Values range from 5 W to 50 W, adjustable in increments of 1 W.
 - Manually enter a value in the **Speaker Wattage** field.
3. Select the impedance of the speaker on a selected zone from the **Impedance** drop-down menu. Values are **4 Ohms** and **8 Ohms**.

NOTE: The DM-NAX-4ZSA-50 does not support output bridging.

Casting

— Casting (Autosaved)

Maximum Casting Volume 100 %

Casting Name *

AirPlay

Spotify

⚠ AirPlay casting Service will be available in a future release.

The Casting section is used to enable or disable the ability of third-party devices to cast audio to the DM NAX output zone, as well as set a maximum casting volume and friendly name for the zone.

To configure Casting:

1. **Maximum Casting Volume** is an alternate value for the **Maximum** volume set under [Minimum/Maximum Volume on page 271](#), applied to the zone only when a casting service is routed to it. To set the maximum casting volume, do one of the following:
 - Move the **Maximum Casting Volume** slider right to increase or left to decrease the maximum volume.
 - Use the arrows to increase or decrease the maximum casting volume. Values range from 70% to 100%, adjustable in increments of 1%.
 - Manually enter a value in the **Maximum Casting Volume** field.

NOTE: If the **Maximum Casting Volume** value is higher than the regular **Maximum** volume value, the **Maximum** value will be applied instead.

2. A custom casting name (for example, "Living Room") must be entered so that a name for the zone will be displayed in the list of available casting destinations when initiating a stream. Enter this friendly name in the **Casting Name** field.

NOTE: Ensure that the **Casting Name** field is populated as any field with an asterisk (*) is mandatory.

Once Apple AirPlay® and/or Spotify Connect™ is enabled, this name will be displayed as an available destination on the casting device.

The DM-NAX-4ZSA-50 supports Apple AirPlay 2 casting.

To stream media from an iOS® device to a zone on the DM-NAX-4ZSA-50 via AirPlay casting:

1. Ensure that the iOS device and DM-NAX-4ZSA-50 are on the same network.

NOTE: If Port Selection is enabled on the DM-NAX-4ZSA-50, AirPlay will use the port specified for Control/Media traffic.

2. Set the **AirPlay** toggle to the right to enable AirPlay casting to the zone's associated media player.
3. On your iOS device:
 - a. Enable AirPlay.
 - b. From the list of available AirPlay destinations, select the DM-NAX-4ZSA-50 media player you would like to stream to. The iOS device will cast the streaming audio to the selected media player.

NOTE: By default, media players 1-5 route to their respectively numbered output zones 1-5 if they are not already routed to any other zones when casting playback begins. For example, the audio from the media player 5 will be routed to output zone 5 if an AirPlay casting session on media player 5 starts and it is not already routed to another zone.

- c. After the AirPlay stream begins, control the volume of the streaming DM-NAX-4ZSA-50 output zone directly from your iOS device.

Set the **AirPlay** toggle to the left to disable AirPlay casting for a DM-NAX-4ZSA-50 media player.

The DM-NAX-4ZSA-50 supports Spotify Connect™ casting.

To stream media to a zone on the DM-NAX-4ZSA-50 via Spotify Connect casting:

1. Ensure that the casting device and DM-NAX-4ZSA-50 are on the same network.

NOTE: If Port Selection is enabled on the DM-NAX-4ZSA-50, Spotify Connect will use the port specified for Control/Media traffic.

2. Set the **Spotify Connect** toggle to the right to enable Spotify Connect casting to the zone's associated media player.
3. On the casting device:
 - a. Open the Spotify application.
 - b. Enable Spotify Connect casting.
 - c. From the list of available casting destinations, select the DM-NAX-4ZSA-50 media player you would like to stream to. The device will cast the streaming audio to the selected media player.

NOTE: By default, media players 1-5 route to their respectively numbered output zones 1-5 if they are not already routed to any other zones when casting playback begins. For example, the audio from the media player 5 will be routed to output zone 5 if an AirPlay casting session on media player 5 starts and it is not already routed to another zone.

- d. After the Spotify Connect stream begins, control the volume of the streaming DM-NAX-4ZSA-50 output zone directly from the Spotify application on the casting device.

Set the **Spotify Connect** toggle to the left to disable Spotify Connect casting for a DM-NAX-4ZSA-50 media player.

To stream media from a Roon® streaming device to a zone in your distributed audio system:

1. Enable Apple AirPlay casting for each DM NAX zone.
2. Launch the Roon desktop app.
3. Open the Roon app menu and navigate to the **Settings** submenu, then select **Audio**. A table of discovered network devices that the Roon device can stream to will be displayed. Any devices that previously have been enabled for Roon casting are listed under the **Connected to Core** section, and the rest of the discovered devices are listed under **Other network devices**.
4. Find each of the DM NAX zones in the **Other network devices** list, then select **Enable** for each zone to connect it to the Roon Core® for casting.
5. Return to the Roon app home page and select the speaker icon at the bottom right. Select a DM NAX zone from the list of available casting destinations. With a zone selected, start a media stream, and the Roon device will cast the streaming audio to the zone.

Speaker/Faults

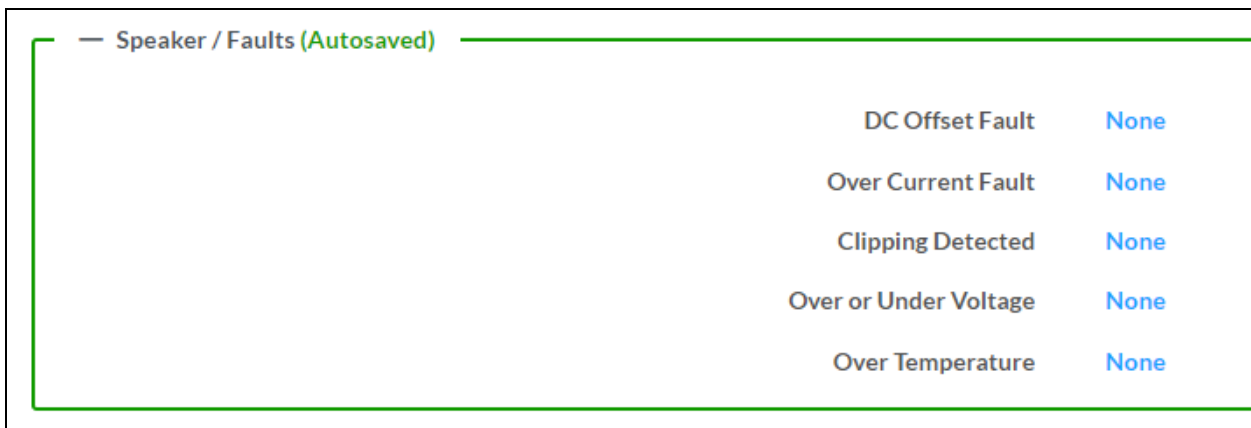

The Speaker/Faults section is a read-only field that displays the status of the **DC Offset Fault**, **Over Current Fault**, **Clipping Detected**, **Over or Under Voltage**, and **Over Temperature** detectors for the zone output. If clipping or a given fault type is detected, then its corresponding readout displays **Fault Detected** in red. Otherwise, it displays **None** in blue.

Signal Generator

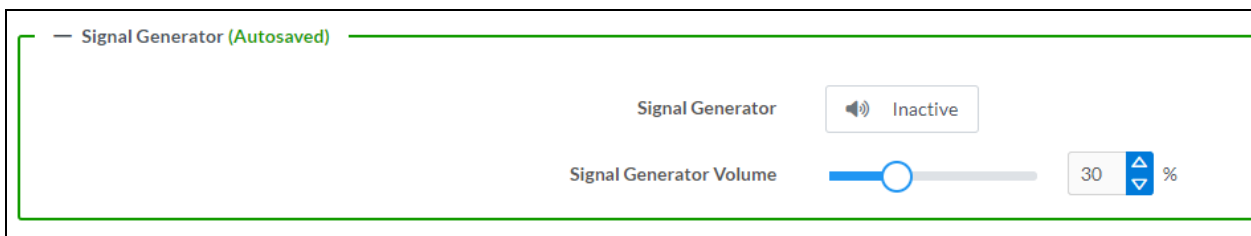

The DM-NAX-4ZSA-50 has a built-in signal generator that allows an integrator to send an audio signal to any number of selected zones to test output functionality.

1. To route the signal generator to the zone output, select **Signal Generator** so that it displays **Active** and is highlighted in blue. To unroute the signal generator on the zone output, select **Signal Generator** so that it displays **Inactive** and is highlighted in grey. By default, the signal generator is not routed to the zone output.

NOTES:

- There is only one signal generator built-in to the DM NAX device. Each zone has its own button to enable or disable the signal generator from passing signal to that output. Setting the signal generator to **Inactive** on a given zone output only breaks the route for that output and does not stop it from playing back in other zones.
- The **Signal Generator Volume** control is a local control that does not affect the signal generator's volume on other zone outputs. Only the settings under **Advanced Signal Generator** are applied universally to all zones of the DM NAX device.

2. To adjust the signal generator's volume, do one of the following:
 - Move the **Signal Generator Volume** slider right to increase or left to decrease the volume.
 - Use the arrows to increase or decrease the signal generator volume. Values range from 0 to 100, adjustable in increments of 1.
 - Manually enter a value in the **Signal Generator Volume** field.

Advanced Signal Generator

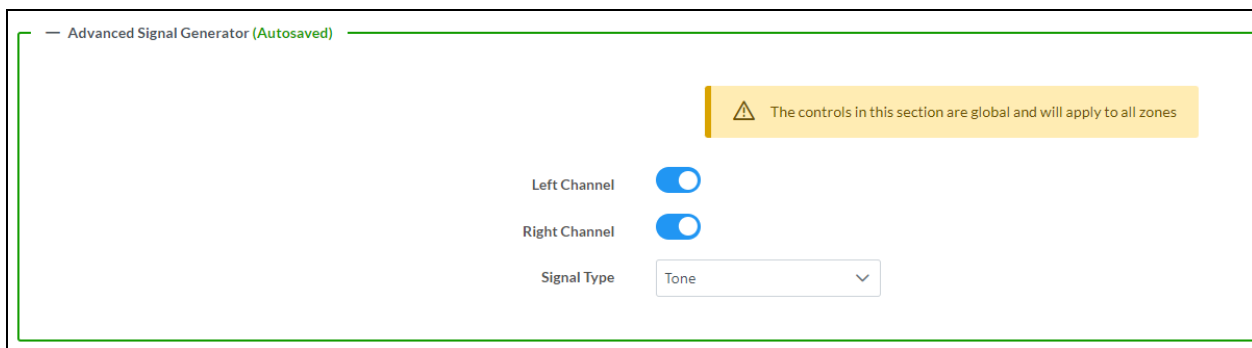

The advanced signal generator settings control the built-in signal generator directly, and are applied universally to all output zones of the DM NAX device. The signal type for the generator can be set, and the left and right channels of the test signal can be individually enabled or disabled.

1. Set the **Left Channel** toggle to the right position to enable the left channel of the signal. Set the toggle to the left position to disable the left channel. By default, **Left Channel** is enabled.
2. Set the **Right Channel** toggle to the right position to enable the right channel of the signal. Set the toggle to the left position to disable the right channel. By default, **Right Channel** is enabled.
3. Select an audio test signal type from the **Signal Type** drop-down menu. The available signal types are:
 - **Tone**: Generates a 1 kHz sine wave tone.
 - **Pink Noise**: Generates pink noise.
 - **White Noise**: Generates white noise.

Equalizer Settings

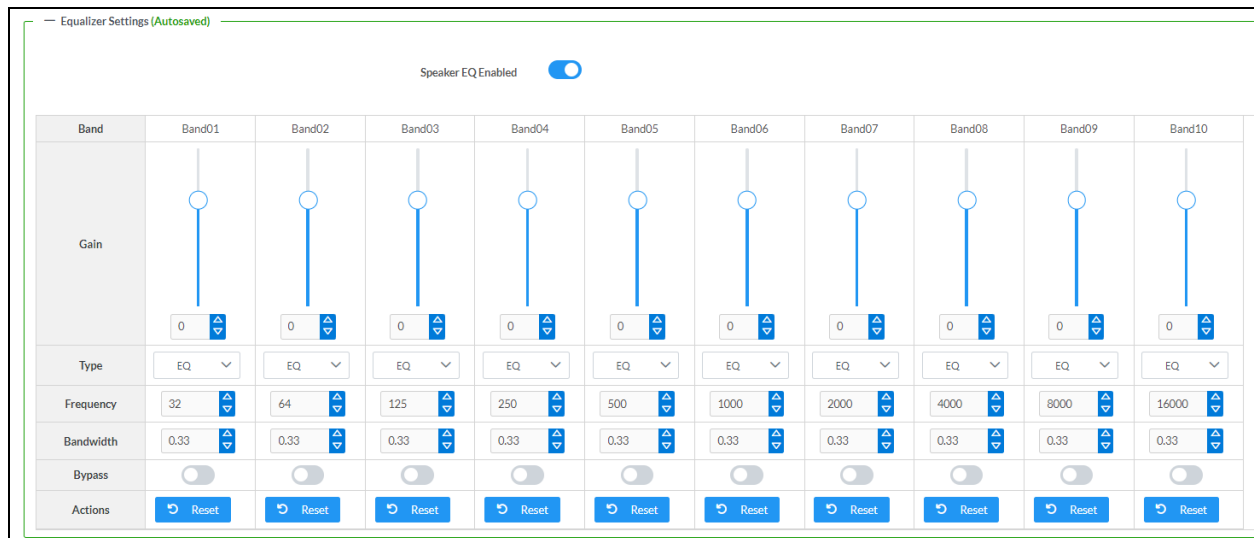

Band	Band01	Band02	Band03	Band04	Band05	Band06	Band07	Band08	Band09	Band10
Gain	<input type="range" value="0"/>	<input type="range" value="0"/>	<input type="range" value="0"/>	<input type="range" value="0"/>	<input type="range" value="0"/>	<input type="range" value="0"/>	<input type="range" value="0"/>	<input type="range" value="0"/>	<input type="range" value="0"/>	<input type="range" value="0"/>
Type	EQ	EQ	EQ	EQ	EQ	EQ	EQ	EQ	EQ	EQ
Frequency	32	64	125	250	500	1000	2000	4000	8000	16000
Bandwidth	0.33	0.33	0.33	0.33	0.33	0.33	0.33	0.33	0.33	0.33
Bypass	<input type="checkbox"/>	<input type="checkbox"/>	<input type="checkbox"/>	<input type="checkbox"/>	<input type="checkbox"/>	<input type="checkbox"/>	<input type="checkbox"/>	<input type="checkbox"/>	<input type="checkbox"/>	<input type="checkbox"/>
Actions	Reset	Reset	Reset	Reset	Reset	Reset	Reset	Reset	Reset	Reset

Each zone output of the DM-NAX-4ZSA-50 has a dedicated ten-band equalizer that can be fully customized to tune the zone output signal to the needs of an install. Each band can have a discrete gain, filter type, center frequency, and bandwidth set, and can also be bypassed. The equalizer itself can also be bypassed using the **Speaker EQ Enabled** toggle.

1. Set the **Speaker EQ Enabled** toggle to the right position to enable the equalizer. Set the toggle to the left position to bypass the equalizer.

NOTE: When **Speaker EQ Enabled** is disabled, all equalizer bands are bypassed. This is a quick way to perform A/B testing of the entire EQ curve.

2. With the **Speaker EQ Enabled** toggle in the right position, configure the equalizer bands.
 - a. To set a band's gain, do one of the following:
 - Move the **Gain** slider up to increase or down to decrease the gain.
 - Use the arrows to increase or decrease the gain. Values range from -40 dB to 20 dB, adjustable in increments of 0.1 dB.
 - Manually enter a value in the **Gain** field.

- b. Select a filter type from the **Type** drop-down menu. By default, all bands are set to the **EQ** filter type. Some filter types will disable other settings in their respective band while enabled. For example, selecting the **LowPass** filter type for a band will disable that band's **Gain** and **Bandwidth** settings, since the **LowPass** filter applies a fixed roll-off slope at a set frequency. The available filter types are:
- **EQ:** a fully parametric filter that can boost or cut a range of frequencies.
 - **Notch:** a parametric filter designed to more precisely cut a frequency or range of frequencies. A notch filter can achieve a narrower bandwidth than the standard **EQ** parametric filter type.
 - **TrebleShelf:** a filter that boosts or cuts all frequencies above a set frequency by a set gain.
 - **BassShelf:** a filter that boosts or cuts all frequencies below a set frequency by a set gain.
 - **LowPass:** a filter that fully cuts all frequencies above a set frequency using a fixed roll-off slope of -12 dB per octave.
 - **HighPass:** a filter that fully cuts all frequencies below a set frequency using a fixed roll-off slope of -12 dB per octave.
- c. Set a center frequency for the equalizer band to tune a specific portion of the audible frequency spectrum. To set the center frequency, do one of the following:
- Use the arrows to increase or decrease the frequency. Values range from 20 Hz to 20 kHz, adjustable in increments of 1 Hz. Each band has a default center frequency that will be applied if **Reset** at the bottom of the band is selected.
 - Manually enter a value in the **Frequency** field.
- d. Set a bandwidth to determine how wide of a frequency range is effected by the equalizer band. To set the bandwidth, do one of the following:
- Use the arrows to increase or decrease the bandwidth. Values range from 0.1 octaves to 4.0 octaves, adjustable in increments of 0.1 octave.
 - Manually enter a value in the **Bandwidth** field.
- e. The individual Bypass controls allow you to bypass a single band of equalization at a time for more granular A/B testing of a single filter. Set a band's **Bypass** toggle to the right position to bypass that band. Set the toggle to the left position to disable the bypass. By default, **Bypass** is disabled.
- f. Each equalizer band has a **Reset** that will reapply the default settings for that band.

Select **Done** to return to the **Settings** tab of the web user interface.

Bussing

The bussing feature on DM NAX devices allows an integrator to assign any number of selected zones to a fixed group of zones (bus). Zones in a bus track the other zones' volume and routing. For example, when the source or volume for one zone in the bus is adjusted, all other zones in that bus receive the same adjustment. You can create up to two buses on the DM-NAX-4ZSA-50.

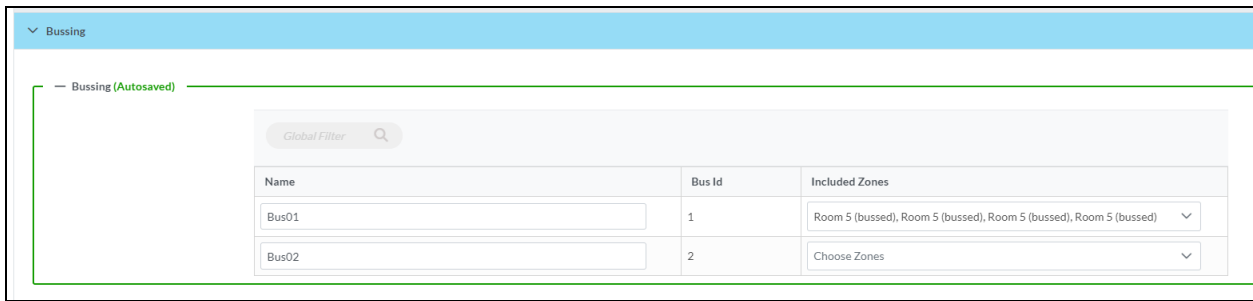

Configure Bussing

1. If needed, enter a friendly name for each bus in its **Name** field.
2. Select any number of zones from the **Included Zones** drop-down menu.

NOTE: Each zone can be a member of only one bus. Any zones that are already a member of another bus will not be shown in the **Included Zones** drop-down.

Inputs

The **Inputs** section is used to configure the **Name**, **Compensation**, and **Mute** attributes of the available analog and digital inputs on the DM-NAX-4ZSA-50.

A total of 9 inputs are available on the DM-NAX-4ZSA-50, including the 4 physical input connectors on the device's rear panel and the 5 internal media players used for media streaming services. Only the attributes of the 4 physical inputs can be adjusted in the **Inputs** section.

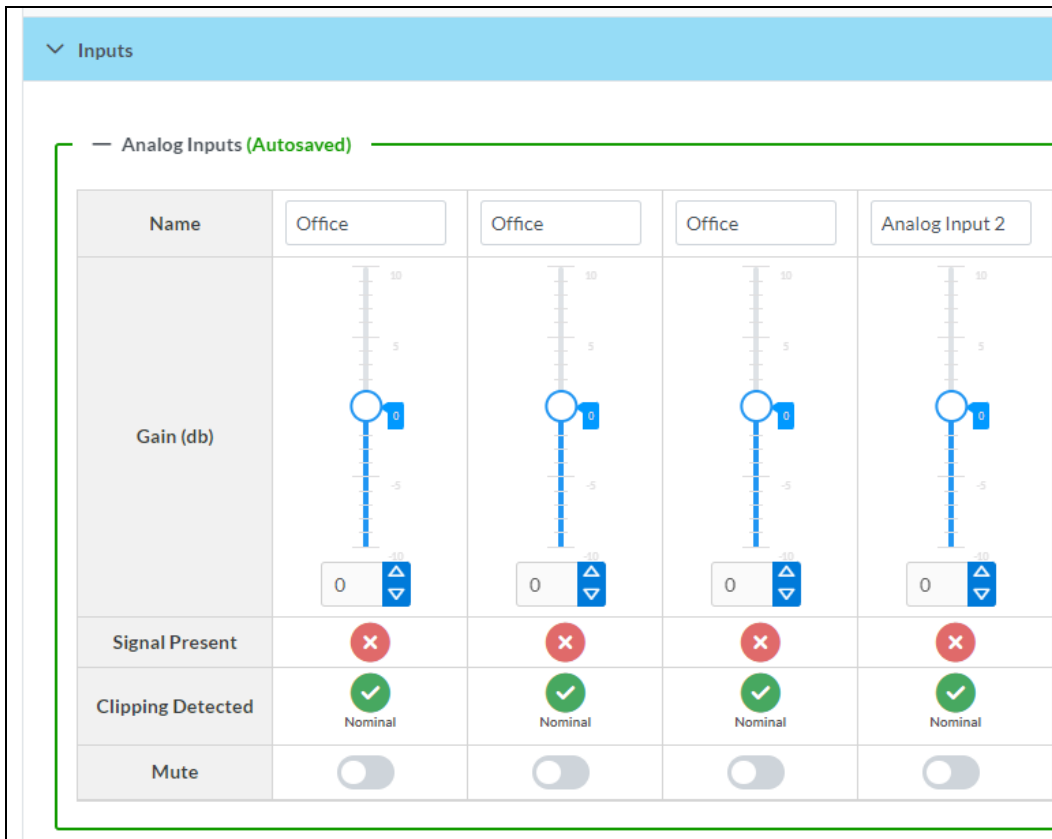

Configure Inputs

1. If needed, enter a friendly name for each input in its **Name** field.
2. To set a level compensation adjustment for a given input, do one of the following:
 - Move the **Gain** slider up to increase or down to decrease the level compensation. Compensation increases or decreases the level of the incoming audio signal on any of the physical inputs on the device's rear panel.
 - Use the **db** arrows to increase or decrease the compensation. Values range from -10 dB to 10 dB, adjustable in increments of 1 dB.
 - Manually enter a value in the **Gain** field.
3. To mute the signal from the corresponding input, select **Mute** . To disable the mute, select **Muted**. By default, **Mute** is disabled.

Monitor the device's input signals using the text indicators in the **Signal Present** and **Clipping Detected** columns:

- **Signal Presence** indicates whether or not a signal is detected in that zone.
- **Clipping Detected** indicates if the signal is **Clipping** or **Nominal** (non-clipping).

DM NAX Streams

Each local input of the DM-NAX-4ZSA-50 can be made available as a DM NAX audio-over-IP stream. This includes the four physical inputs on the rear panel of the device and the five internal media players.

Select **NAX Streams** to expand the tab and display the following information.

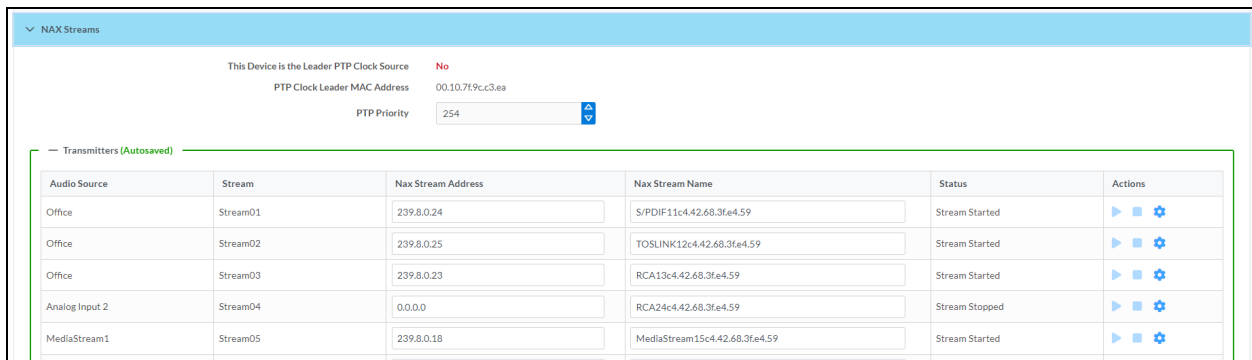

Audio Source	Stream	Nax Stream Address	Nax Stream Name	Status	Actions
Office	Stream01	239.8.0.24	S/PDIF11c4.42.68.3fe4.59	Stream Started	▶ ■ ⚙
Office	Stream02	239.8.0.25	TOSLINK12c4.42.68.3fe4.59	Stream Started	▶ ■ ⚙
Office	Stream03	239.8.0.23	RCA13c4.42.68.3fe4.59	Stream Started	▶ ■ ⚙
Analog Input 2	Stream04	0.0.0.0	RCA24c4.42.68.3fe4.59	Stream Stopped	▶ ■ ⚙
MediaStream1	Stream05	239.8.0.18	MediaStream15c4.42.68.3fe4.59	Stream Started	▶ ■ ⚙

- **Device is Leader PTP Clock Source** indicates whether the DM NAX device's PTP clock is the leader clock on the network. **Yes** will be displayed in green when the local DM-NAX-4ZSA-50's clock is the PTP leader clock and **No** will be displayed in red when another PTP clock on the network is operating as the leader clock.
- **Leader Clock Status** displays the Leader Clock ID of the device on the network that is currently acting as the leader clock.
- **PTP Priority**: This sets the priority of the local DM NAX device's PTP clock relative to other clocks on the network. The default setting is 254 (one increment higher than the lowest possible value) so that the DM-NAX-4ZSA-50 will only operate as the leader clock if no other PTP leader is present on the network. Valid values range from 1 to 255.

Configure Transmitters

Audio Source	Stream	Nax Stream Address	Nax Stream Name	Status	Actions
Office	Stream01	239.8.0.24	S/PDIF11c4.42.68.3fe4.59	Stream Started	▶ ⚙
Office	Stream02	239.8.0.25	TOSLINK12c4.42.68.3fe4.59	Stream Started	▶ ⚙
Office	Stream03	239.8.0.23	RCA13c4.42.68.3fe4.59	Stream Started	▶ ⚙
Analog Input 2	Stream04	0.0.0.0	RCA24c4.42.68.3fe4.59	Stream Stopped	▶ ⚙
MediaStream1	Stream05	239.8.0.18	MediaStream15c4.42.68.3fe4.59	Stream Started	▶ ⚙
MediaStream2	Stream06	239.8.0.19	MediaStream26c4.42.68.3fe4.59	Stream Started	▶ ⚙
MediaStream3	Stream07	239.8.0.20	MediaStream37c4.42.68.3fe4.59	Stream Started	▶ ⚙
MediaStream4	Stream08	239.8.0.21	MediaStream48c4.42.68.3fe4.59	Stream Started	▶ ⚙

NOTE: To configure transmitters not shown on the current page of the table, select the ▶ icon to display the next page of transmitters.

To configure a DM NAX transmit stream:

1. Enter a valid multicast address in the **NAX Stream Address** field.
2. Enter a name in the **NAX Stream Name** field by which the stream can be identified. This stream name is associated with the DM NAX stream's multicast address by other DM NAX or AES67 devices, like a device hostname that resolves to a given IP address.
3. **Status** indicates whether a stream is transmitting or not. When the stream has started or stopped, the **Status** column will update accordingly.
4. Select the configure icon ⚙ in the **Actions** column. The **Configure** dialog appears:

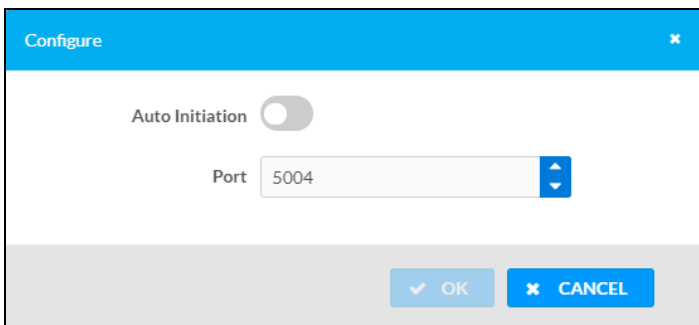

5. Set the **Auto Initiation** toggle to the right position to enable auto initiation. Set the toggle to the left position to disable auto initiation.
 - If **Auto Initiation** is enabled for a given stream, the stream will begin transmitting automatically and will be available as a multicast stream on your network at the specified multicast address.
 - If **Auto Initiation** is disabled for the input, the stream will not begin transmitting until it is manually initiated.

6. To set the port number, do one of the following:
 - Use the arrows to increase or decrease the port number by increments of 1.
 - Manually enter a port number in the **Port** field. The default port number for DM NAX streams is 5004.
7. Select **OK** to save or select **Cancel** to cancel the changes.

Configure Receivers

Zone Name	Stream	Current Stream Address	Requested Stream Address	Status	Actions
Room 5 (bussed)	Stream01	0.0.0.0	0.0.0.0	Stream Stopped	▶ ■ ⚙
Room 5 (bussed)	Stream02	0.0.0.0	0.0.0.0	Stream Stopped	▶ ■ ⚙
Room 5 (bussed)	Stream03	0.0.0.0	0.0.0.0	Stream Stopped	▶ ■ ⚙
Room 5 (bussed)	Stream04	0.0.0.0	0.0.0.0	Stream Stopped	▶ ■ ⚙
Zone5	Stream05	0.0.0.0	0.0.0.0	Stream Stopped	▶ ■ ⚙

1. Enter the multicast address of a transmitting stream in the **Requested Stream Address** field to subscribe the receiver to the stream.
2. Select the configure icon  in the **Actions** column. The **Configure** dialog appears:

Configure ✕

Auto Initiation

Port

3. Set the **Auto Initiation** toggle to the right position to enable auto initiation. Set the toggle to the left position to disable auto initiation.
 - If **Auto Initiation** is enabled, the stream will begin automatically when the receiver subscribes to the transmitter.
 - If **Auto Initiation** is disabled, the stream will not begin until it is manually initiated.
4. To set the port number, do one of the following:
 - Use the arrows to increase or decrease the port number by increments of 1.
 - Manually enter a port number in the **Port** field. The default port number is 5004.
5. Select **OK** to save or select **Cancel** to cancel the changes.

Routing

The **Routing** section is used to route a local input, media player, or AES67 stream to a Zone on the DM-NAX-4ZSA-50.

NOTE: To receive an AES67 stream from Dante devices, see [OLH 1001151](#).

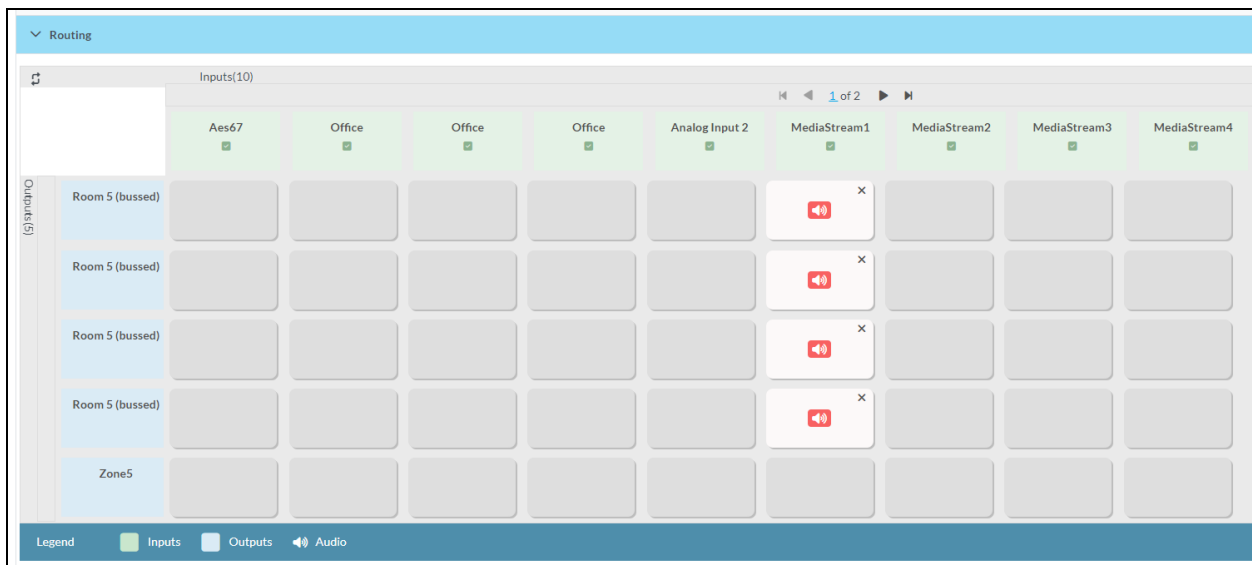

- To route an input to a zone, select the box in the routing matrix where the zone's row overlaps the corresponding input's column. Once a route is made, appears.
- To break a given route select or .
- To route a single input to all zones, select the icon under the input's name.

Use the arrows (or) at the top of the matrix to change pages to view all available inputs.

To select a specific DM NAX/AES67 stream when AES67 is selected as the source for a zone:

- Select the gear icon  to display the list of all DM NAX/AES67 streams discovered on the network, then select the corresponding stream to be routed to the zone.

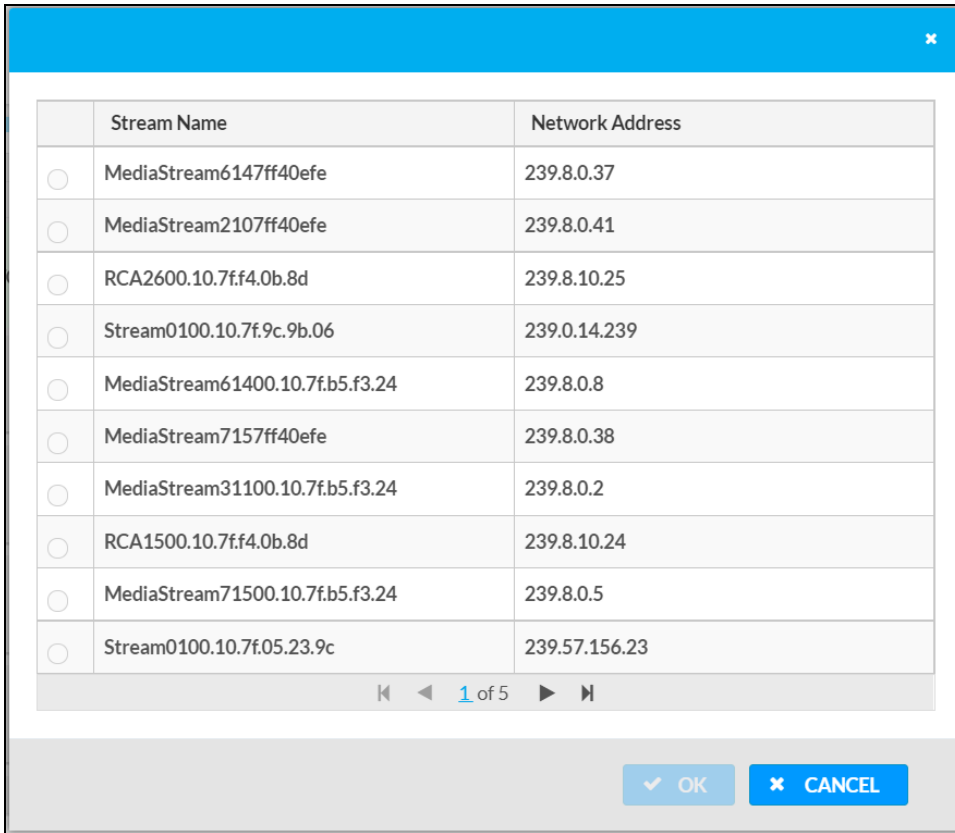

	Stream Name	Network Address
<input type="radio"/>	MediaStream6147ff40efe	239.8.0.37
<input type="radio"/>	MediaStream2107ff40efe	239.8.0.41
<input type="radio"/>	RCA2600.10.7f.f4.0b.8d	239.8.10.25
<input type="radio"/>	Stream0100.10.7f.9c.9b.06	239.0.14.239
<input type="radio"/>	MediaStream61400.10.7f.b5.f3.24	239.8.0.8
<input type="radio"/>	MediaStream7157ff40efe	239.8.0.38
<input type="radio"/>	MediaStream31100.10.7f.b5.f3.24	239.8.0.2
<input type="radio"/>	RCA1500.10.7f.f4.0b.8d	239.8.10.24
<input type="radio"/>	MediaStream71500.10.7f.b5.f3.24	239.8.0.5
<input type="radio"/>	Stream0100.10.7f.05.23.9c	239.57.156.23

- Select **OK** to save or select **Cancel** to cancel the changes.

Streaming Services

The DM-NAX-4ZSA-50 features five built-in media streaming players, each of which can play back a discrete media stream from a cloud-based service or local casting device. User Profiles can be created for each user of the DM NAX device with discrete credentials, enabling multiple users access to media streaming services without interfering with other users' recommendations, favorites, or playlists.

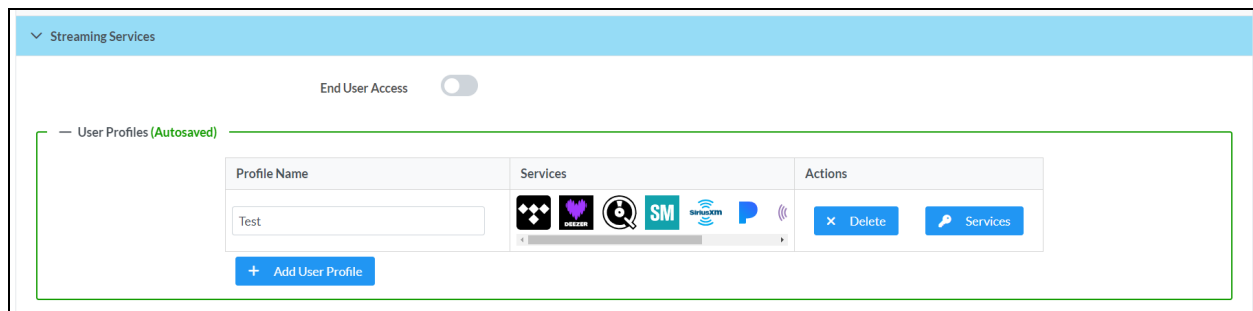

To configure Streaming Services:

1. Select **+ Add User Profile** to create a new user profile. Each user profile can contain a unique set of accounts for all supported streaming services.
2. Enter a name in the **Profile Name** field. Select **Save** to create the **User Profile**. Once the profile is created, you have the option to either **Delete** the profile, or add **Services** to it.
3. Select **Services** in the **Action** column and an **Edit Services** window appears.

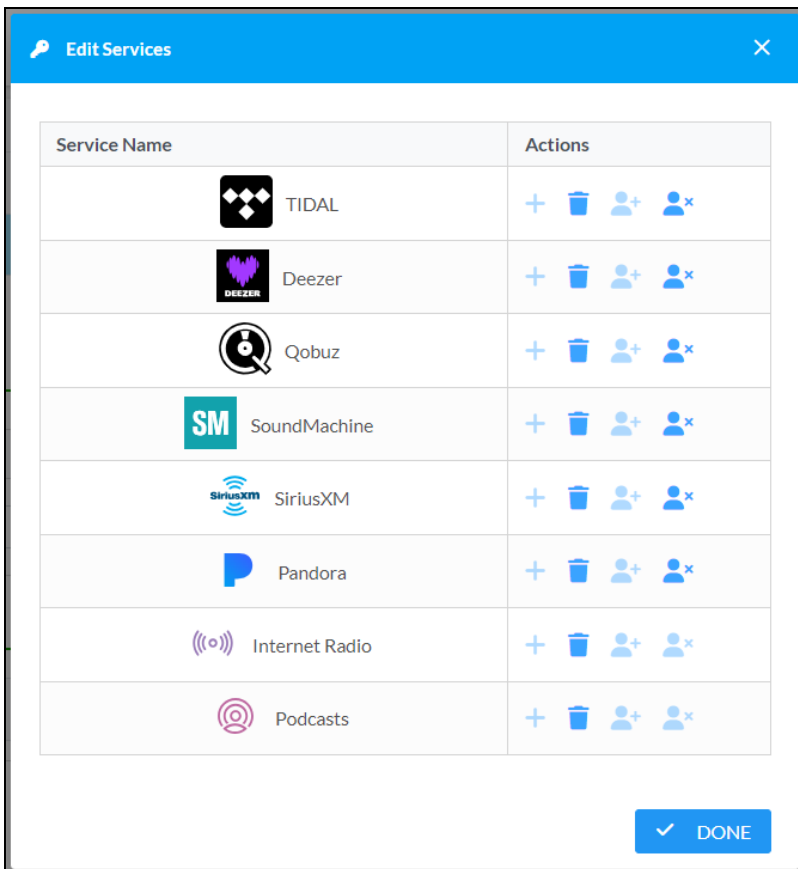

4. Select from the available Streaming Services: **TIDAL™**, **Deezer®**, **Qobuz®**, **SOUNDMACHINE®**, **SiriusXM®**, **Pandora®**, **Internet Radio**, and **Podcasts**. Select **+** or **🗑️** to add or delete the desired streaming services for each user profile.

User Authentication

User authentication is required for TIDAL, Deezer, Qobuz, SOUNDMACHINE, SiriusXM and Pandora. Select  to authorize the user.

To authenticate SiriusXM streaming:

NOTE: To determine whether to use commercial accounts, refer to the streaming service license agreement or FAQs on their respective portals. Refer to [this link](#) for SiriusXM documentation.

Enter the user credentials and select **OK**.

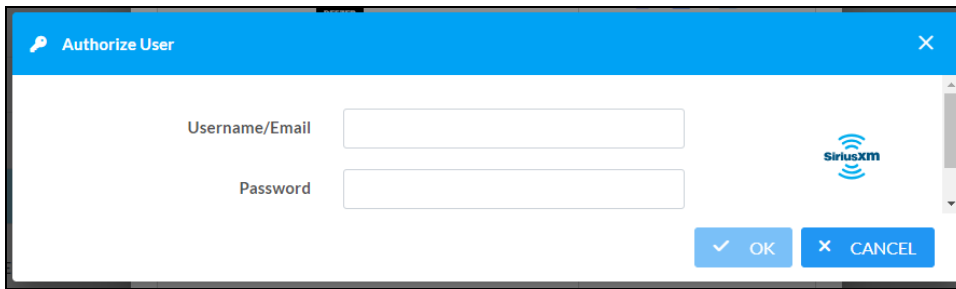

To authenticate TIDAL streaming:

1. Select the link to log in to the TIDAL portal.

NOTE: The link is valid for one minute. After one minute, the link expires, and the **Authorize URL** is shown as blank. The **Authorize User** dialogue will need to be closed and reopened.

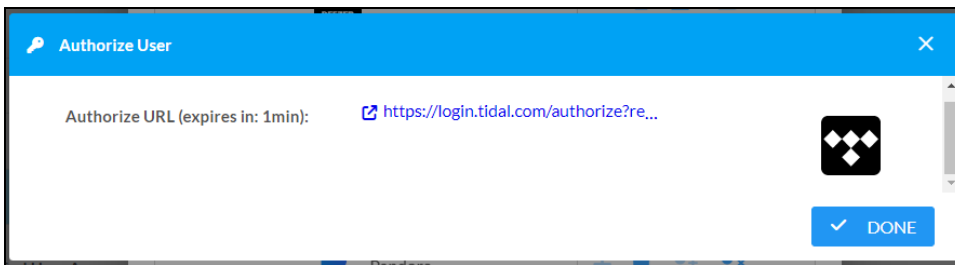

2. Select **DONE** to return to **Streaming Services**.

To authenticate Deezer streaming:

1. Select the link to log in to the Deezer portal.

NOTE: The link is valid for one minute. After one minute, the link expires, and the **Authorize URL** is shown as blank. The **Authorize User** dialogue will need to be closed and reopened.

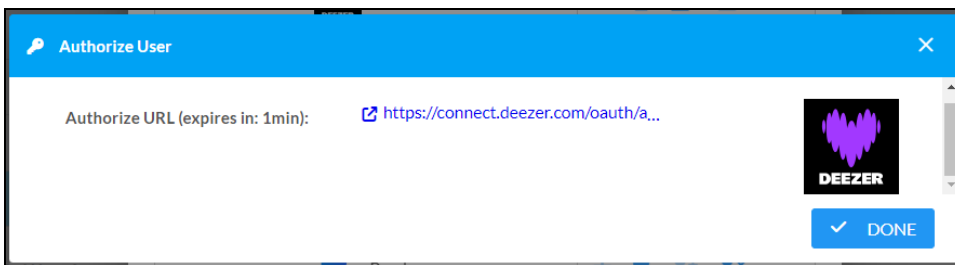

2. Select **DONE** to return to **Streaming Services**.

To authenticate Qobuz streaming:

1. Select the link to log in to the Qobuz portal.

NOTE: The link is valid for one minute. After one minute, the link expires, and the **Authorize URL** is shown as blank. The **Authorize User** dialogue will need to be closed and reopened.

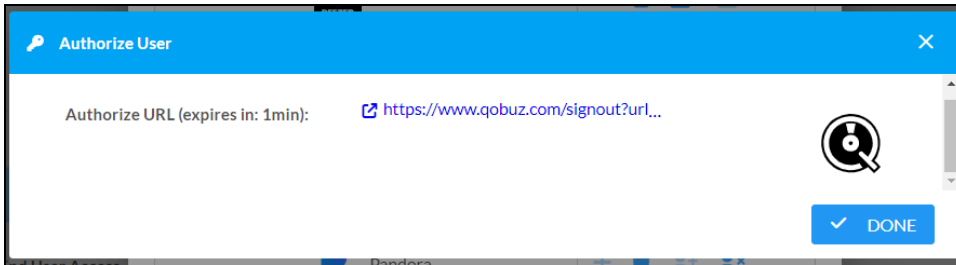

2. Select **DONE** to return to **Streaming Services**.

To authenticate SOUNDMACHINE streaming:

NOTE: To determine whether to use commercial accounts, refer to the streaming service license agreement or FAQs on their respective portals. Refer to [this link](#) for SOUNDMACHINE documentation.

1. Select the link to log in to the SOUNDMACHINE portal.

NOTE: The link is valid for one minute. After one minute, the link expires, and the **Authorize URL** is shown as blank. The **Authorize User** dialogue will need to be closed and reopened.

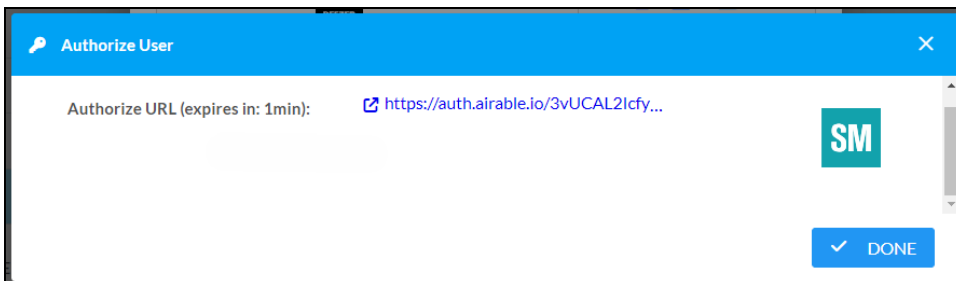

2. Log in to the SOUNDMACHINE account.

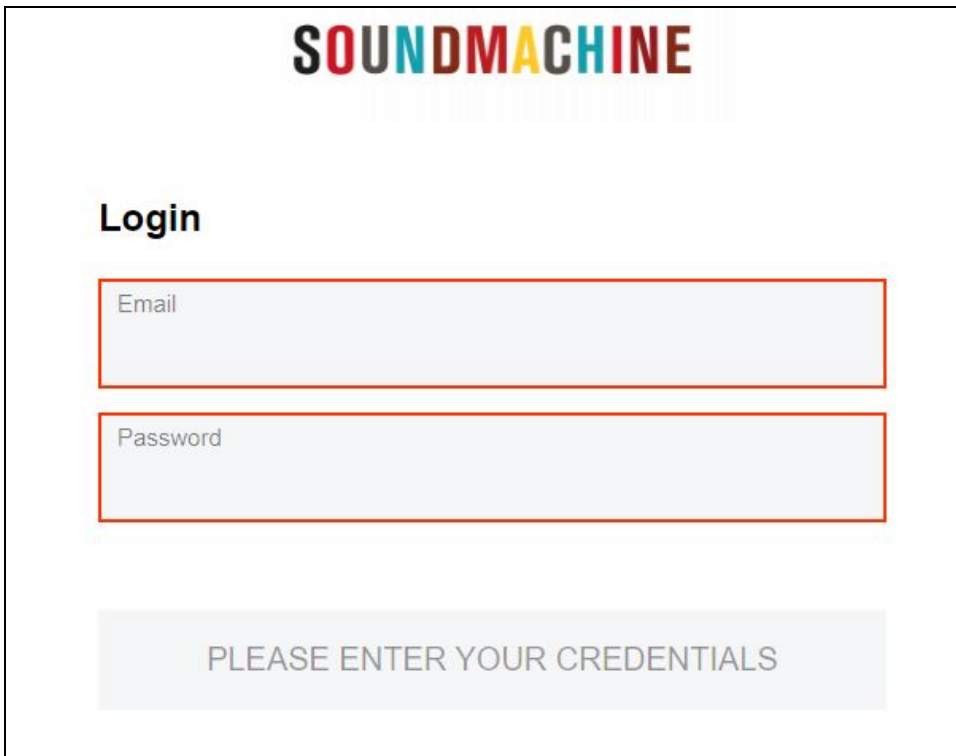

The image shows a login screen for SoundMachine. At the top center is the "SOUNDMACHINE" logo in a colorful, multi-colored font. Below the logo is the text "CRESTRON". Underneath that is the heading "Login". There are two input fields: "Email" and "Password", both with red borders. Below these fields is a large, light gray button with the text "PLEASE ENTER YOUR CREDENTIALS".

3. Select **DONE** to return to **Streaming Services**.

To authenticate Pandora streaming:

1. Select the  icon to copy the activation code.

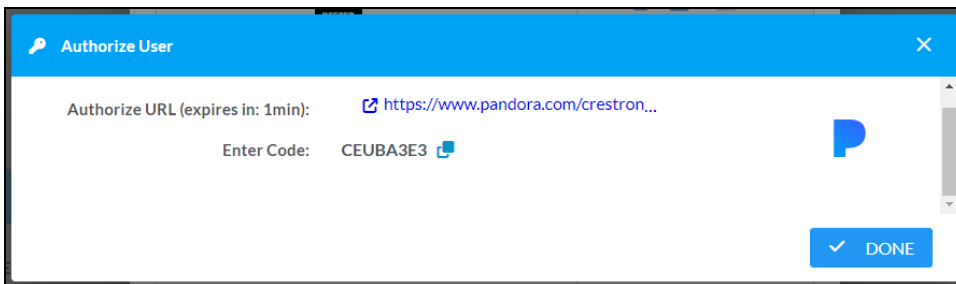

The image shows a "Authorize User" dialog box from Pandora. The title bar is blue and contains a close button (X). The main content area is white and contains the following text: "Authorize URL (expires in: 1min):" followed by a blue link icon and the URL "https://www.pandora.com/crestron...". Below that is "Enter Code: CEUBA3E3" followed by a blue copy icon. On the right side of the dialog is the Pandora logo (a blue 'P'). At the bottom right is a blue button with a white checkmark and the text "DONE".

2. Select the link to register the device. The **Device Activation** page is displayed.

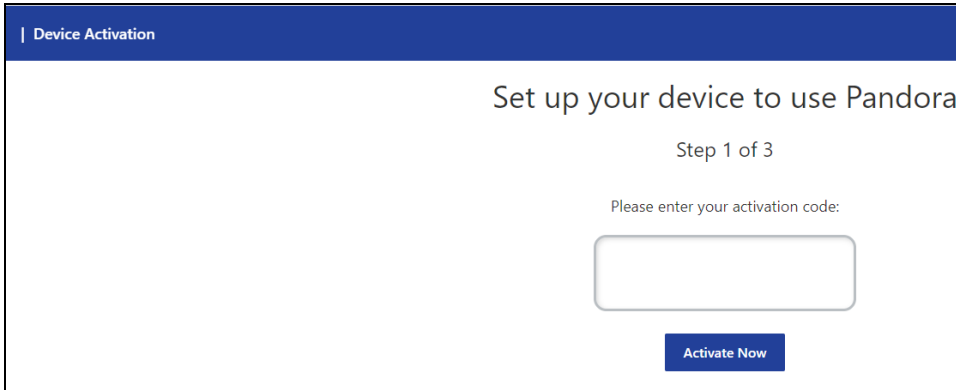

NOTE: The link is valid for one minute. After one minute, the link expires, and the **Authorize URL** and **Enter Code** are shown as blank. The **Authorize User** dialogue will need to be closed and reopened.

3. Paste the activation code in the **Please enter your activation code** field and select **Activate Now**.
4. Log in to the Pandora account.
5. Select **DONE** to return to **Streaming Services**.

Port Selection

The **Port Selection** feature allows the device's internal network traffic to be managed and segregated based on traffic type. Internal VLANs are used to segment device management and streaming service traffic to a separate physical device Ethernet port than audio-over-IP streaming traffic. With **Port Selection** enabled on all DM NAX devices on a network, DM NAX and AES67 network traffic can be physically separated from the control network onto a dedicated audio network.

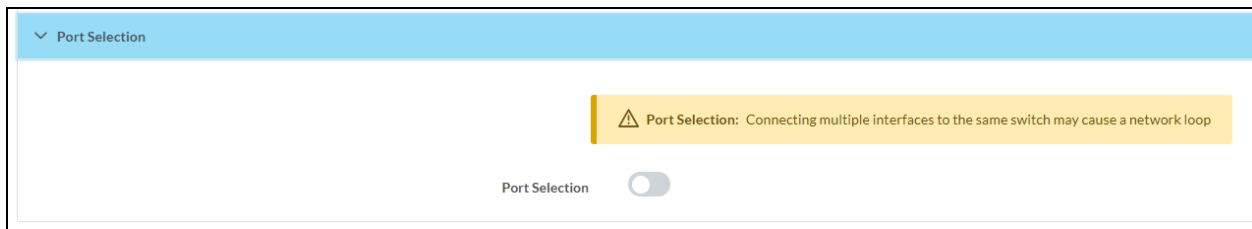

To configure **Port Selection**:

1. Set the **Port Selection** toggle to the right position to enable Port Selection. Set the toggle to the left position to disable Port Selection. By default, **Port Selection** is disabled.

NOTE: Ports 1 and 2 correspond to the Ethernet adapters labeled **1** and **2** on the rear panel of the DM-NAX-4ZSA-50, respectively.

2. With **Port Selection** enabled:

- a. Select an Ethernet port from the **Management** drop-down menu to designate which Ethernet port on the rear panel of the device will handle network traffic relating to device configuration, streaming services, and the device's connection to a control system.

NOTES:

- To access streaming services, the Management port must be connected to a network with internet access.
- The Management port determines your connection to the web interface. Changing the port value can result in losing your connection to the device via the web interface.

- b. Select an Ethernet port from the **Audio/NAX** drop-down menu to designate which Ethernet port on the rear panel of the device will handle audio-over-IP streaming network traffic.

3. Select **Save** changes to apply the new settings.

NOTE: Making changes to **Port Selection** settings will require a reboot.

Security

Select the **Security** tab to configure security for users and groups and to allow different levels of access to the DM-NAX-4ZSA-50 functions. By default, security is disabled.

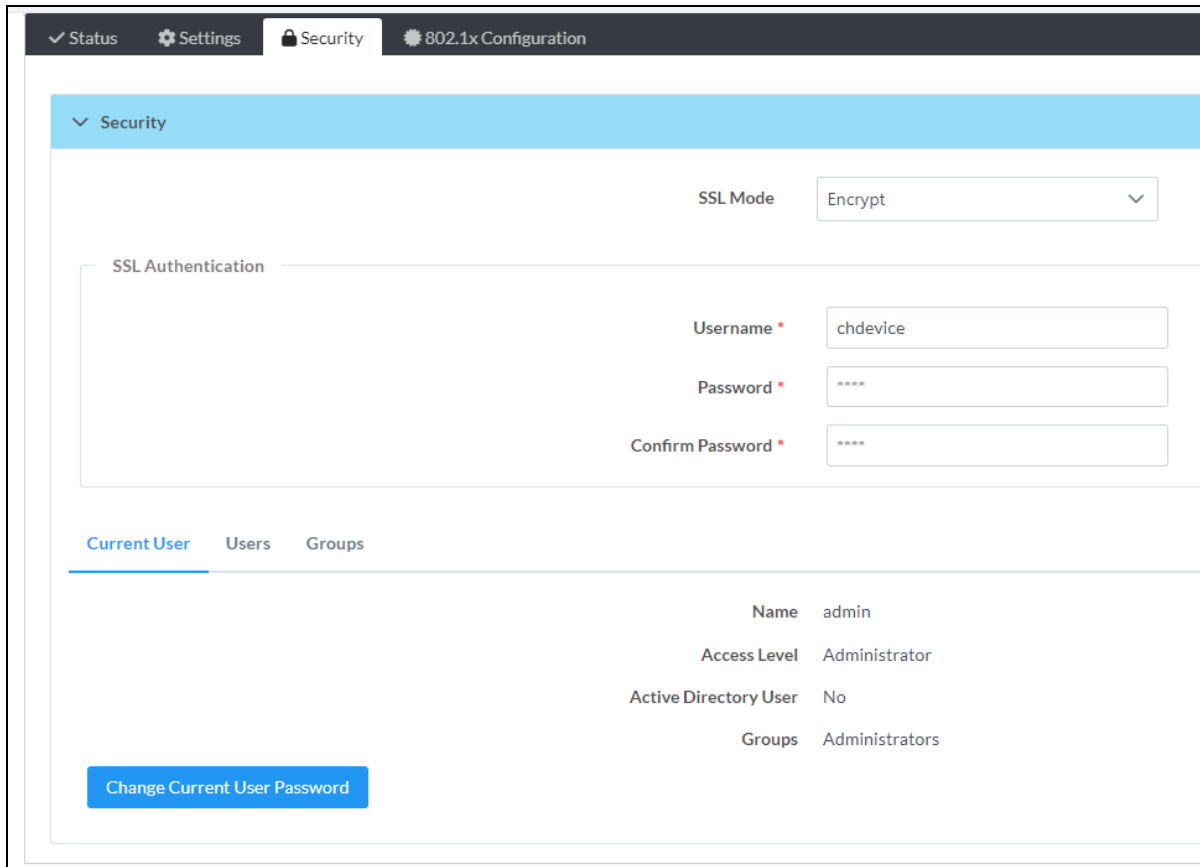

Select **Encrypt and Validate**, **Encrypt**, or **OFF** in the **SSL Mode** drop-down menu, to specify whether to use encryption. By default, SSL Mode is set to **OFF**.

Current User

Select the **Current User** tab to view read-only information or to change the password for the current user.

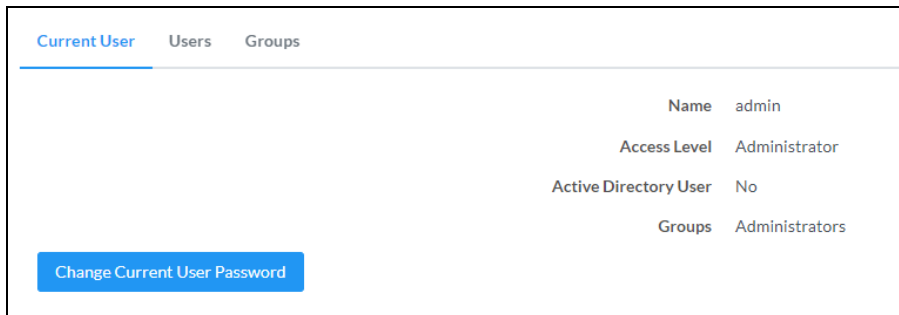

1. Select **Change Current User Password** to provide a new password for the current user.
2. In the **Change Password** dialog, enter the current password in the **Current Password** field, the new password in the **Password** field, and then re-enter the same new password in the **Confirm Password** field.

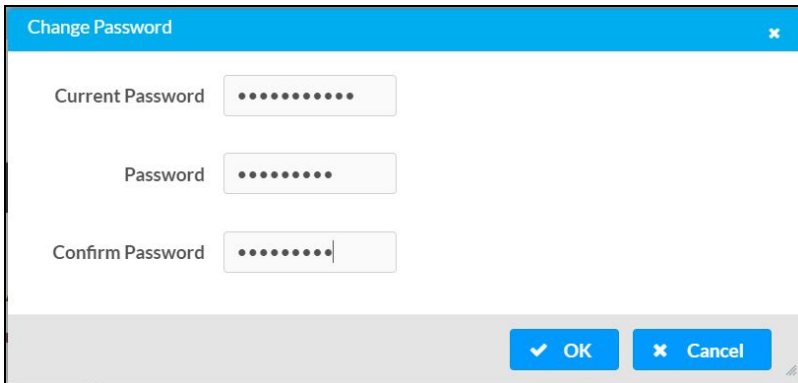

The image shows a 'Change Password' dialog box with a blue header and a close button. It contains three password input fields: 'Current Password', 'Password', and 'Confirm Password'. Each field is filled with dots. At the bottom, there are two buttons: 'OK' with a checkmark icon and 'Cancel' with an 'X' icon.

3. Select **OK** to save or select **Cancel** to cancel the changes.

Users

Select the **Users** tab to view and edit user settings. The **Users** tab can be used to add or remove local and Active Directory users and preview information about users.

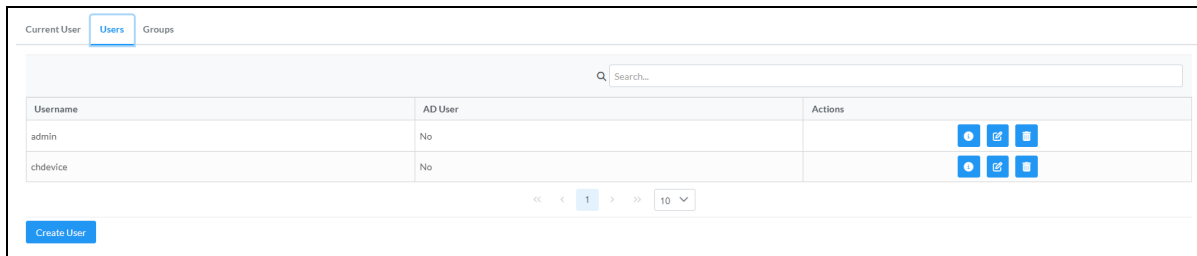

The image shows a web interface for managing users. At the top, there are tabs for 'Current User', 'Users', and 'Groups'. Below the tabs is a search bar labeled 'Search...'. A table lists users with columns for 'Username', 'AD User', and 'Actions'. The table contains two rows: 'admin' and 'chdevice', both with 'AD User' set to 'No'. The 'Actions' column for each row contains three icons: a magnifying glass, a document with a pencil, and a trash can. Below the table is a pagination control showing '1' of 10 items.

Username	AD User	Actions
admin	No	[View] [Edit] [Delete]
chdevice	No	[View] [Edit] [Delete]

Use the **Search Users** field to enter search term(s) and display users that match the search criteria.

If users listed in the **Users** table span across multiple pages, navigate through the list of users by selecting a page number or by using the left or right arrows at the bottom of the **Users** pane to move forward or backward through the pages.

Each page can be set to display 5, 10, or 20 users by using the drop-down menu to the right of the navigation arrows.

Information about existing users is displayed in table format and the following details are provided for each user.

- **Username:** Displays the name of the user.
- **AD User:** Displays whether the user requires authentication using Active Directory.

Select the corresponding icon in the Actions column to view detailed user information or to delete the user.

To create a new user, select **Create User**.

Create a New Local User

1. Select **Create User** in the **Users** tab.
2. In the **Create User** dialog, enter the following:

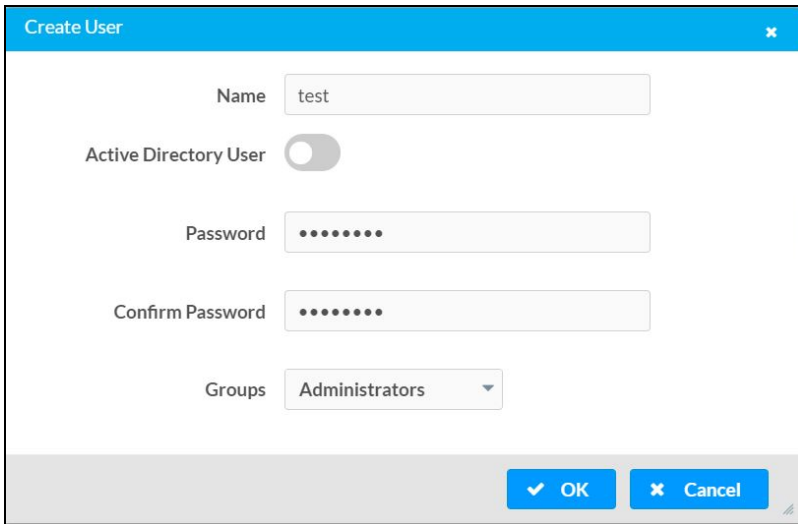

- a. Enter a user name in the **Name** field. A valid user name can consist of alphanumeric characters (letters a-z, A-Z, numbers 0-9) and the underscore "_" character.
- b. Enter a password in the **Password** field; re-enter the same password in the **Confirm Password** field.
- c. Assign the access level by selecting one or more groups from the **Groups** drop-down list.

NOTE: Make sure that the **Active Directory User** toggle is disabled.

3. Select **OK** to save or select **Cancel** to cancel the changes.

Add an Active Directory User

Users cannot be created or removed from the Active Directory server, but access can be granted to an existing user in the Active Directory server.

To grant access to an Active Directory user, you can either add the user to a local group on the DM-NAX-4ZSA-50, or add the Active Directory group(s) that they are a member of to the DM-NAX-4ZSA-50.

To add an Active Directory user:

1. Select **Create User**.
2. In the **Create User** dialog, enter the following.

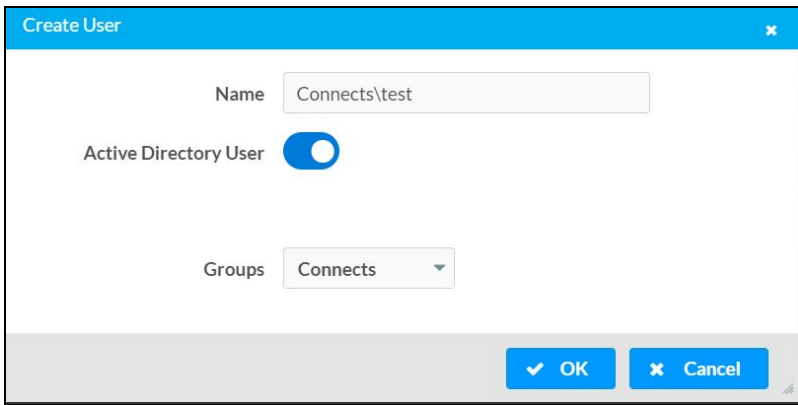

- a. Enter a user name in the **Name** field in the format "Domain\UserName", for example "crestronlabs.com\JohnSmith". Valid user names can contain alphanumeric characters (letters a-z, A-Z, numbers 0-9) and the underscore "_" character.
- b. Select one or more groups from the **Groups** drop-down list.

NOTE: Make sure that the **Active Directory User** toggle is set to enabled.

3. Select **OK** to save or select **Cancel** to cancel the changes.

Delete User

Select the trashcan icon  in the **Actions** column to delete the user. Select **Yes** when prompted to delete the user or **No** to cancel the deletion.

After a user is removed from a group, they lose any access rights associated with that group. Note that the user account is not deleted by the delete user operation.

View User Details

Select the information icon  in the **Actions** column to view information for the selected user. The **User Details** dialog displays the following information for the selected user.

- **Name:** Displays the name of the selected user.
- **Active Directory User:** Displays whether the user is an Active Directory user.
- **Group:** Displays group(s) the selected user is part of.

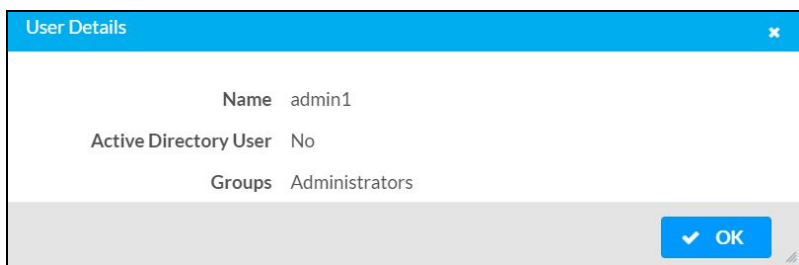

Select **OK** to close the **User Details** dialog and to return to the **Users** tab.

Update User Details

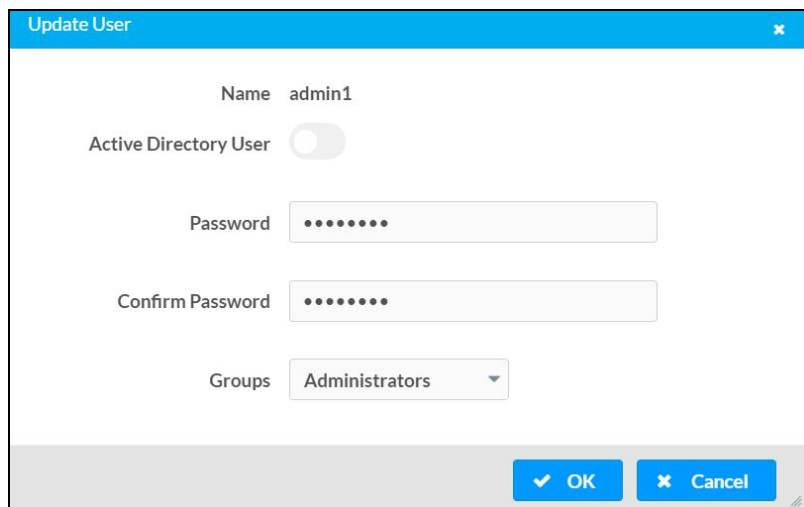

1. Select the edit icon  in the **Actions** column to update information for the selected user.
2. Enter a password in the **Password** field; re-enter the same password in the **Confirm Password** field.
3. Select one or more groups to assign the user to from the **Groups** drop-down list.
4. Select **OK** to save or select **Cancel** to cancel the changes.

The **Update User** dialog also displays the following read-only information for the selected user.









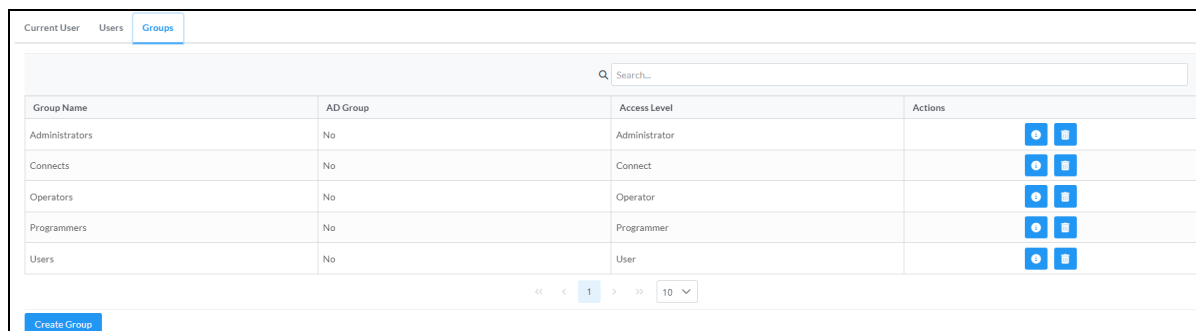

- **Name:** Displays the name of the user.
- **Active Directory User:** Displays whether the user is an Active Directory user.

Groups

Select the **Groups** tab to view and edit group settings. The **Groups** tab can be used to add local and Active Directory groups, remove local and Active Directory groups, and preview information about a group.

Use the **Search Groups** field to enter search term(s) and display groups that match the search criteria.





Group Name	AD Group	Access Level	Actions
Administrators	No	Administrator	 
Connects	No	Connect	 
Operators	No	Operator	 
Programmers	No	Programmer	 
Users	No	User	 

If groups listed in the **Groups** table span across multiple pages, navigate through the groups by selecting a page number or by using the left or right arrows at the bottom of the **Groups** pane to move forward or backward through the pages.

Additionally, each page can be set to display 5, 10, or 20 groups by using the drop-down menu to the right of the navigation arrows.

Existing groups are displayed in a table and the following information is provided for each group:

- **Group Name:** Displays the name of the group.
- **AD Group:** Displays whether the group requires authentication using Active Directory.
- **Access Level:** Displays the predefined access level assigned to the group (Administrator, Programmer, Operator, User, or Connect).

Select the corresponding icon in the **Actions** column to view detailed group information  or to delete  selected group.

Select **Create Group** in the **Groups** tab to create new group.

Create Local Group

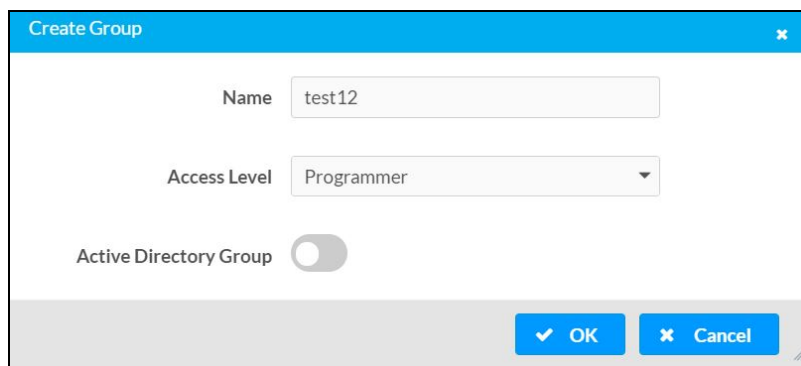

1. Select **Create Group**.
2. In the **Create Group** dialog, enter the following:
 - a. Enter the group name in the **Name** field.
 - b. Assign the group access level by selecting a predefined access level (Administrator, Connect, Operator, Programmer, User) from the **Access Level** drop-down list.

NOTE: Make sure that the **Active Directory Group** toggle is disabled.

3. Select **OK** to save. Select **Cancel** to cancel the changes.

Add Active Directory Group

A group cannot be created or removed from the Active Directory server, but access can be granted to an existing group in Active Directory.

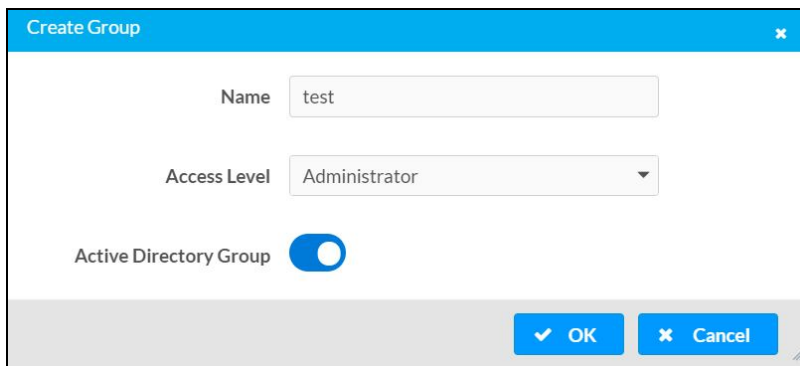

Once the group is added, all members of that group will have access to the DM-NAX-4ZSA-50.

1. Select **Create Group**.
2. In the **Create Group** dialog enter the following:
 - a. Enter the group name in the **Name** field, for example "Engineering Group". Note that group names are case sensitive; a space is a valid character that can be used in group names.
3. Assign the group access level by selecting a predefined access level (Administrator, Connect, Operator, Programmer, User) from the **Access Level** drop-down list.

NOTE: Make sure that the **Active Directory Group** toggle is enabled.

4. Select **OK** to save. Select **Cancel** to cancel the changes.

Delete a Group

Select the trashcan icon  in the **Actions** column to delete a group. Select **Yes** when prompted to delete the group or **No** to cancel the deletion.

When a group is deleted, users in the group are not removed from the device or Active Directory server. However, because a user's access level is inherited from a group(s), users within the deleted group will lose access rights associated with the group.

View Group Details

Select the information icon  in the **Actions** column to view information for the selected group. The **Group Details** dialog lists the following information for the selected group.

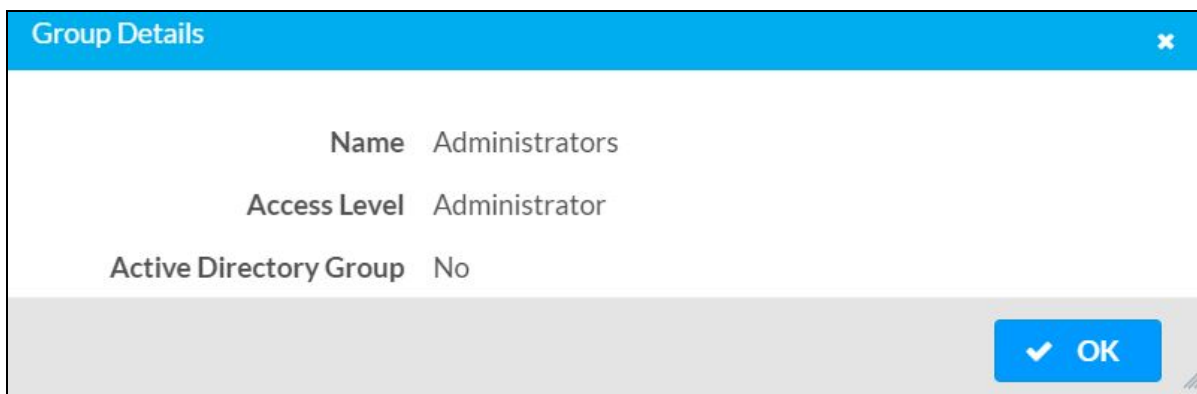

- **Name:** Displays the name of the group.
- **Access Level:** Displays the access level of the group and its users.
- **Active Directory Group:** Displays whether the group is an Active Directory group.

Select **OK** to close the **Group Details** dialog and to return to the **Groups** tab.

802.1x Configuration

The DM-NAX-4ZSA-50 has built-in support for the 802.1X standard (an IEEE network standard designed to enhance the security of wireless and Ethernet LANs. The standard relies on the exchange of messages between the device and the network's host, or authentication server), allowing communication with the authentication server and access to protected corporate networks.

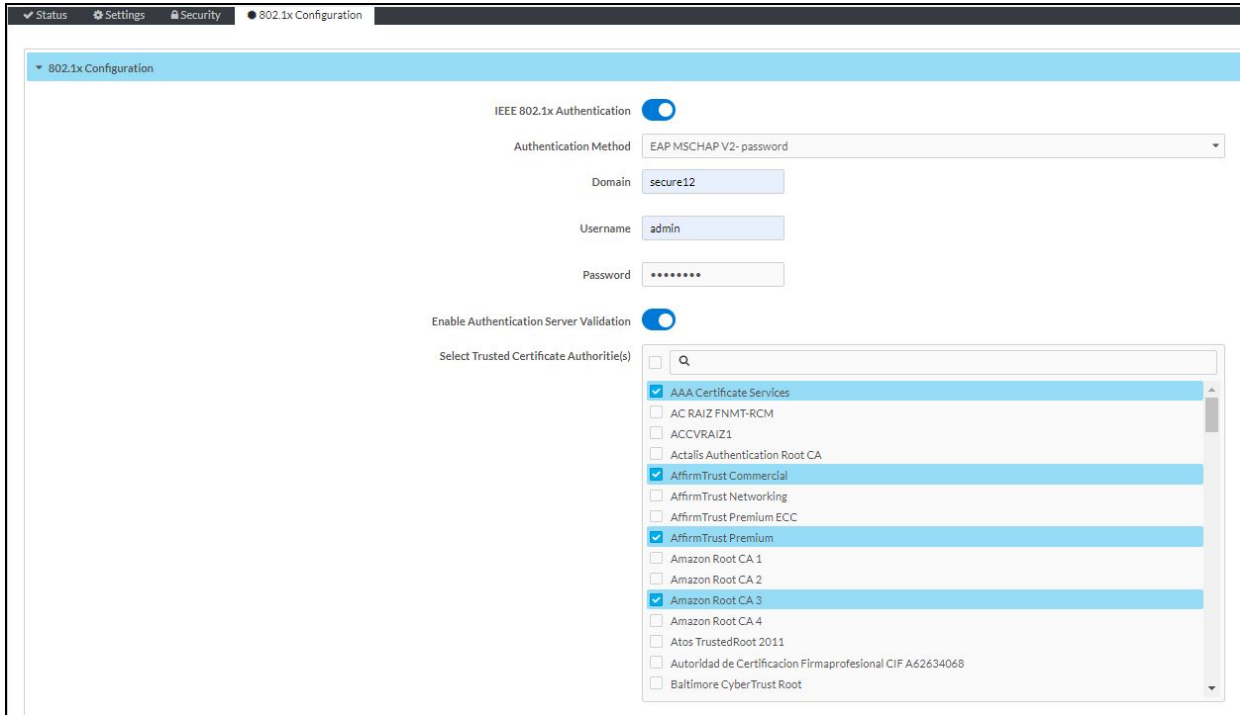

Configure DM-NAX-4ZSA-50 for 802.1X Authentication

1. Set the **IEEE 802.1X Authentication** toggle to enabled. This will enable all options on the 802.1X dialog.
2. Select the **Authentication method: EAP-TLS Certificate** or **EAP-MSCHAP V2 Password** according to the network administrator's requirement.
3. Do either one of the following:
 - Select **EAP-TLS Certificate**: Select **Action/Manage Certificates** to upload the required machine certificate. The machine certificate is an encrypted file that will be supplied by the network administrator, along with the certificate password.
 - Select **EAP-MSCHAP V2 Password**: Enter the username and password supplied by the network administrator into the **Username** and **Password** fields. This method does not require the use of a machine certificate, only the user name and password credentials.

4. If you enabled the **Enable Authentication Server Validation** option, this will enable the **Select Trusted Certificate Authority(ies)** list box which contains signed Trusted Certificate Authorities (CAs) preloaded into the DM-NAX-4ZSA-50.

Select the check box next to each CA whose certificate can be used for server validation, as specified by the network administrator.

If the network does not use any of the listed certificates, the network administrator must provide a certificate, which must be uploaded manually via the **Manage Certificates** functionality.

5. If required, type the domain name of the network in the **Domain** field.
6. When the 802.1X settings are configured as desired, select **Save Changes** to save the changes to the device and reboot it. Select **Revert** to cancel any changes.

DM-NAX-4ZSP

This section describes how to configure DM-NAX-4ZSP.

Web Interface Configuration

The DM-NAX-4ZSP web interface allows you to view status information and configure network and device settings.

Access the Web Interface

To access the web interface, do either of the following:

- [Access the Web Interface with a Web Browser on page 305](#)
- [Access the Web Interface With the Crestron Toolbox™ Application on page 307](#)

The web interface is accessed from a web browser. The following table lists operating systems and their corresponding supported web browsers.

Operating System and Supported Web Browsers

OPERATING SYSTEM	SUPPORTED WEB BROWSERS
Windows® operating system	Chrome™ web browser, version 31 and later Firefox® web browser, version 31 and later Internet Explorer web browser, version 11 and later Microsoft Edge web browser
macOS® operating system	Safari® web browser, version 6 and later Chrome web browser, version 31 and later Firefox web browser, version 31 and later

Access the Web Interface with a Web Browser

1. Enter the IP address of the DM-NAX-4ZSP into a web browser.

NOTE: To obtain the IP address, use the **Device Discovery Tool** option in Crestron Toolbox™ application or an IP scanner application.

2. If you are creating a user account for the first time, do the following; otherwise, skip to step 3.
 - a. Enter a username in the **Username** field.
 - b. Enter a password in the **Password** field.
 - c. Re-enter the same password in the **Confirm Password** field.

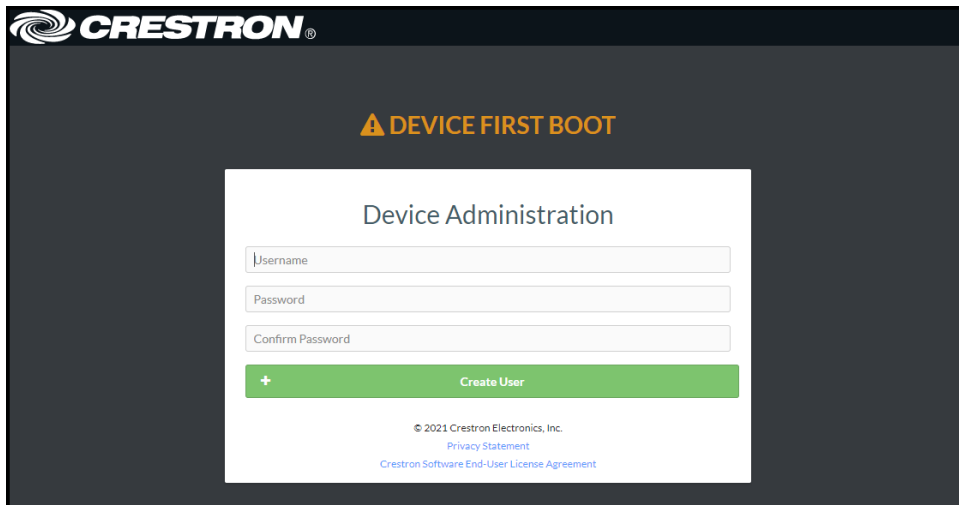

The screenshot shows the Crestron logo at the top left. In the center, there is a warning icon followed by the text "DEVICE FIRST BOOT". Below this, a white box titled "Device Administration" contains three input fields: "Username", "Password", and "Confirm Password". A green button with a plus sign and the text "Create User" is positioned below the fields. At the bottom of the white box, there is copyright information: "© 2021 Crestron Electronics, Inc.", a link for "Privacy Statement", and a link for "Crestron Software End-User License Agreement".

- d. Select **Create User**. The Device Administration page appears.

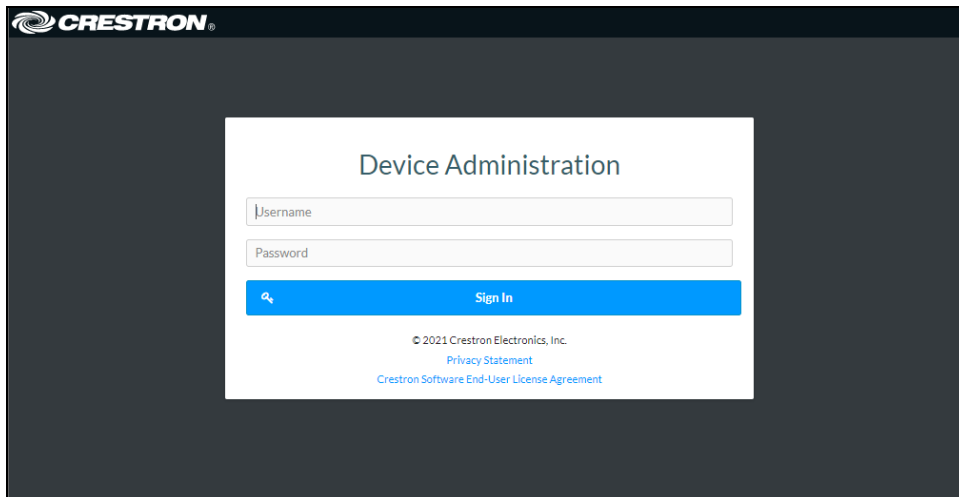

The screenshot shows the Crestron logo at the top left. In the center, a white box titled "Device Administration" contains two input fields: "Username" and "Password". A blue button with a magnifying glass icon and the text "Sign In" is positioned below the fields. At the bottom of the white box, there is copyright information: "© 2021 Crestron Electronics, Inc.", a link for "Privacy Statement", and a link for "Crestron Software End-User License Agreement".

3. Enter the username in the **Username** field.
4. Enter the password in the **Password** field.
5. Select **Sign In**.

Access the Web Interface With the Crestron Toolbox™ Application

To access the web interface by opening a web browser from the Crestron Toolbox™ application:

1. Open the Crestron Toolbox application.
2. From the **Tools** menu, select **Device Discovery Tool**. You can also access the Device Discovery Tool by selecting the Device Discovery Tool icon  in the Crestron Toolbox toolbar. The DM-NAX-4ZSP is discovered and listed in the device list on the left side of the screen. The associated host name, IP address, and firmware version are also displayed.

NOTE: If there is security software running on the computer, a security alert might be displayed when the Crestron Toolbox application attempts to connect to the network. Make sure to allow the connection, so that the Device Discovery Tool can be used.

3. In the Device Discovery Tool list, select the device.
4. Enter the device credentials in the **Authentication Required** dialog that opens, then select **Log In**.
5. Select **Web Configuration**.

Action

The **Action** drop-down menu is displayed at the top right side of the interface and provides quick access to common device functions:

- [Save Changes on page 308](#)
- [Revert on page 308](#)
- [Reboot on page 309](#)
- [Restore to Factory Default Settings on page 309](#)
- [Update Firmware on page 309](#)
- [Download Logs on page 310](#)
- [Manage Certificates on page 310](#)
- [Manage Audio Profiles on page 312](#)
- [Download Configuration on page 313](#)
- [Upload Configuration on page 313](#)

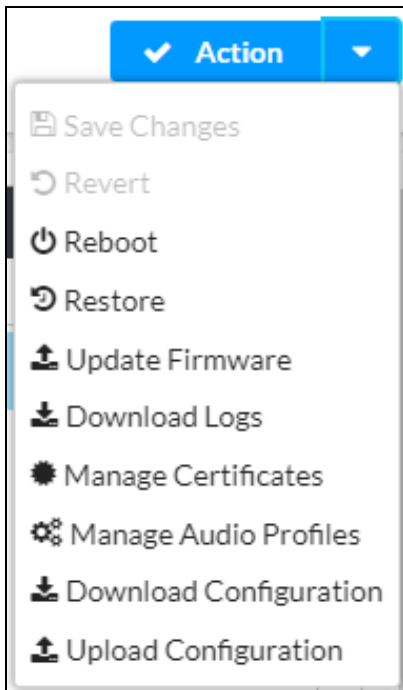

Save Changes

Select **Save Changes** to save any changes made to the configuration settings.

Revert

Select **Revert** to revert the device back to the last saved configuration settings.

Reboot

Certain changes to the settings may require the DM-NAX-4ZSP to be rebooted to take effect. To reboot the device:

1. Select **Reboot** in the **Action** drop-down menu. The **Confirmation** message box appears.

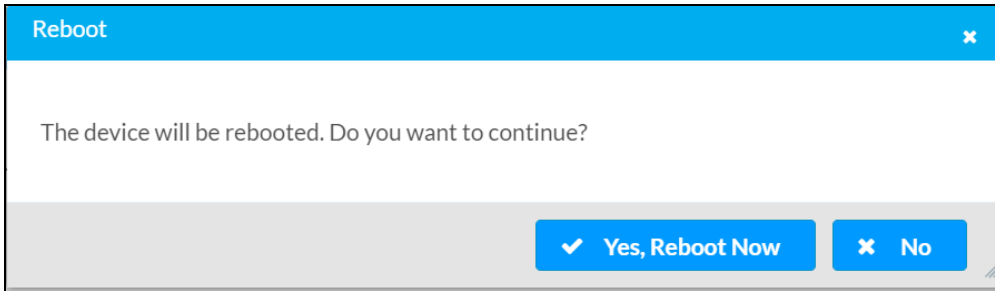

2. Select **Yes, Reboot Now** to reboot the device. The **Reboot** message box appears. Wait for the device reboot to complete before attempting to reconnect to the device.

Restore to Factory Default Settings

1. Select **Restore** in the **Action** drop-down menu to restore the settings of the DM-NAX-4ZSP to factory defaults.

NOTE: When settings are restored, all settings, including the network settings, will revert to the factory default. If a static IP address is set, restoring the device to factory default settings will revert the IP address to the default DHCP mode.

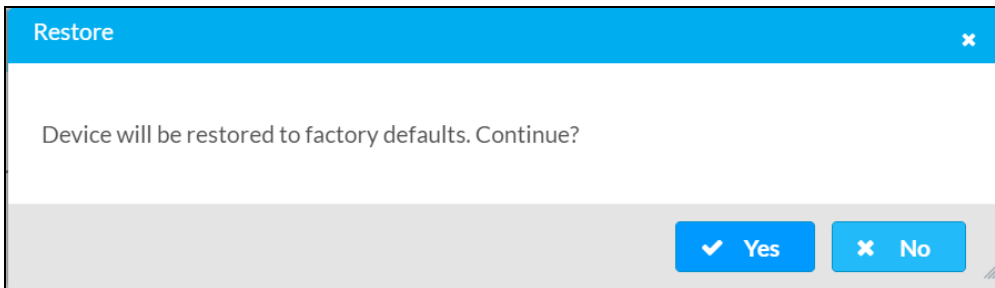

2. Select **Yes** in the **Confirmation** dialog to restore the DM-NAX-4ZSP to factory settings. Select **No** to cancel the restore operation.

A dialog is displayed again, indicating that the restore process was successful and that the device rebooted.

You can also restore to factory settings by pressing and holding the **SETUP** button on the rear panel of the device with power disconnected then connect the power supply and continue to hold **SETUP** button for 30 seconds.

Update Firmware

1. Select **Update Firmware** in the **Action** drop-down menu.
2. In the **Firmware Upgrade** dialog, select **+ Browse**.

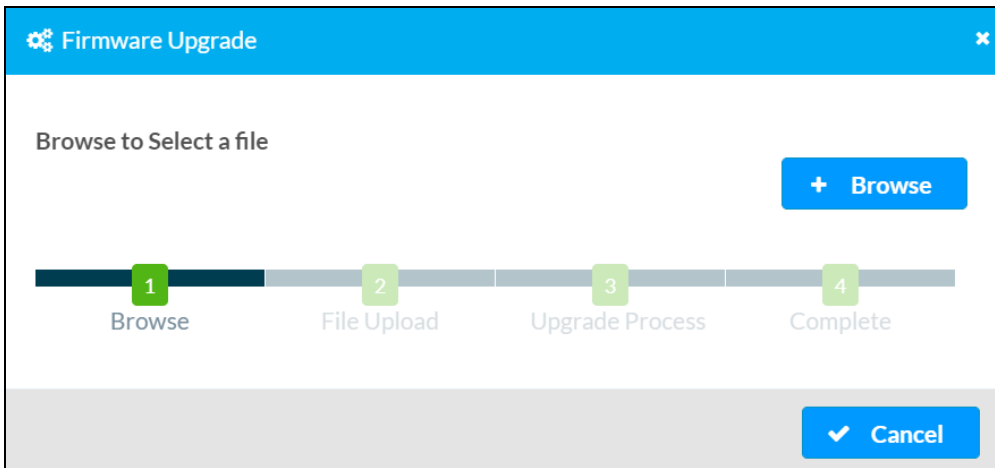

3. Locate and select the desired firmware file, then select **Open**. The selected firmware file name is displayed in the **Firmware Upgrade** dialog.
4. Select **Load** and wait for the progress bar to complete and for **OK** to become selectable.
5. Select **OK**. The device with new firmware can now be accessed.

Download Logs

Select **Download Logs** in the **Action** drop-down menu to download the device message logs for diagnostic purposes.

The log file is downloaded to the Downloads folder of the PC.

Manage Certificates

Use the **Manage Certificates** dialog to add, remove, and manage certificates used in 802.1x and other protected networks.

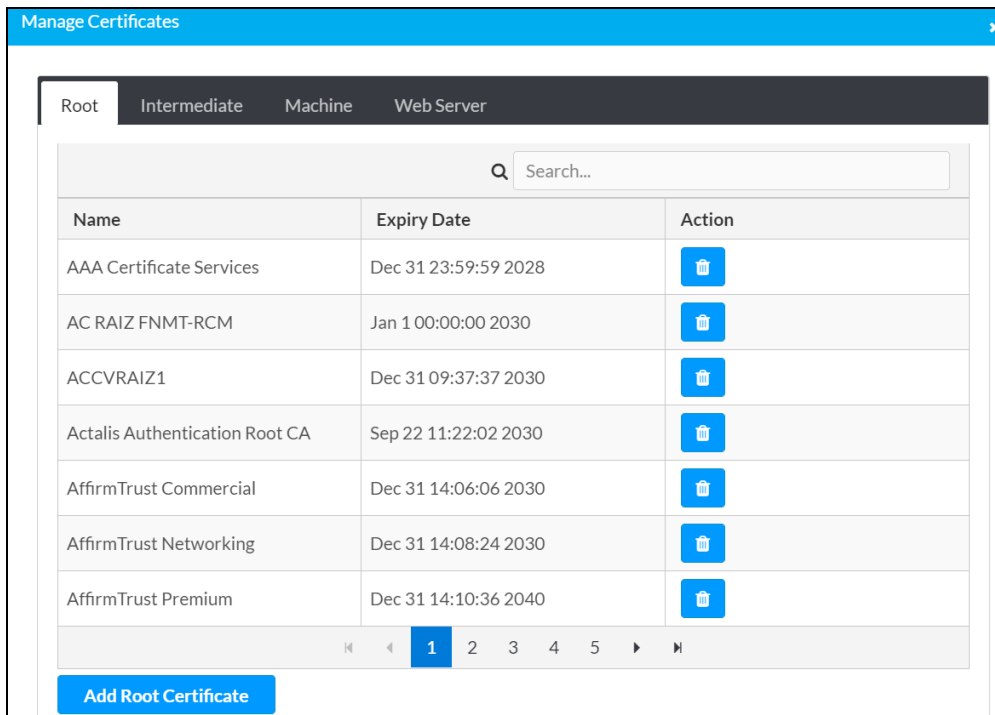

Select **Manage Certificates** in the **Action** drop-down menu. The following certificate tabs are displayed:

- **Root:** The Root certificate is used by the DM-NAX-4ZSP to validate the network's authentication server. The DM-NAX-4ZSP has a variety of Root certificates, self-signed by trusted CAs (Certificate Authorities) preloaded into the device. Root certificates must be self-signed.
- **Intermediate:** The Intermediate store holds non self-signed certificates that are used to validate the authentication server. These certificates will be provided by the network administrator if the network does not use self-signed Root certificates.
- **Machine:** The machine certificate is an encrypted PFX file that is used by the authentication server to validate the identity of the DM-NAX-4ZSP. The machine certificate will be provided by the network administrator, along with the certificate password. For 802.1x, only one machine certificate can reside on the device.
- **Web Server:** The Web Server certificate is a digital file that contains information about the identity of the web server.

To Add Certificates

1. Select the corresponding certificate tab.
2. Select **Add Root Certificate**.
3. Select **+ Browse**.
4. Locate and select the file, and then select **Open**.

NOTE: If the certificate is a Machine Certificate, enter the password provided by the network administrator.

5. Select **OK**. This will add the certificate to the list box, displaying the file name and expiration date. The certificate is now available for selection and can be loaded to the device.

To Delete Certificates

1. Select the corresponding certificate tab.
2. Select the trashcan icon  in the **Actions** column to delete the certificate.
3. Select **Yes** when prompted to delete the certificate or **No** to cancel the deletion.

Manage Audio Profiles

Use the **Manage Audio Profiles** dialog to add, remove, and manage the audio profiles of speakers.

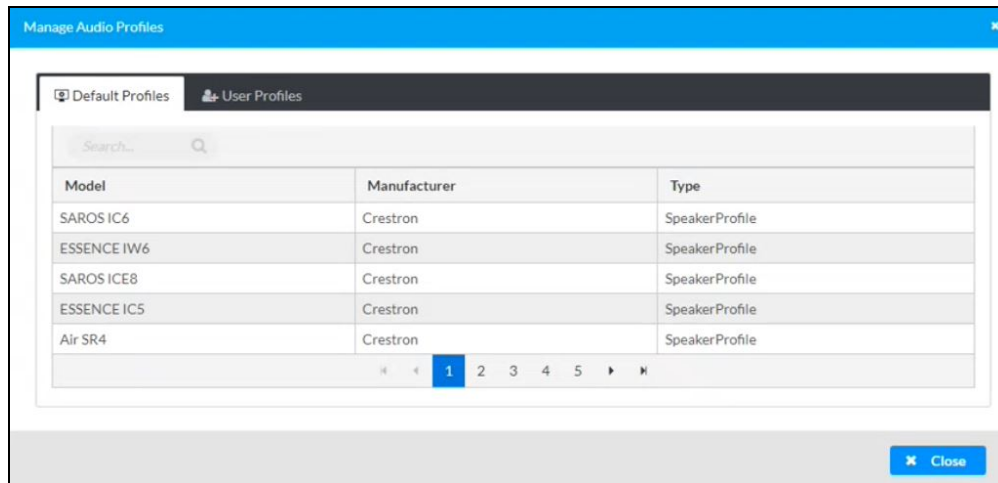

Select **Manage Audio Profiles** in the **Action** drop-down menu. The following audio profiles tabs are displayed, providing information such as **Model**, **Manufacturer**, and **Type** of the speaker profiles:

- **Default Profiles:** Lists the default library of included speaker profiles.
- **User Profiles:** Lists the custom, user loaded profiles, and allows them to be loaded and removed.

In the **Search** field, enter the speaker's profile name to search for the profile. The speaker profile matching the search criteria is displayed.

NOTE: To create a custom speaker profile, see [Online Help Article 1001820](#).

To Add a Speaker Profile

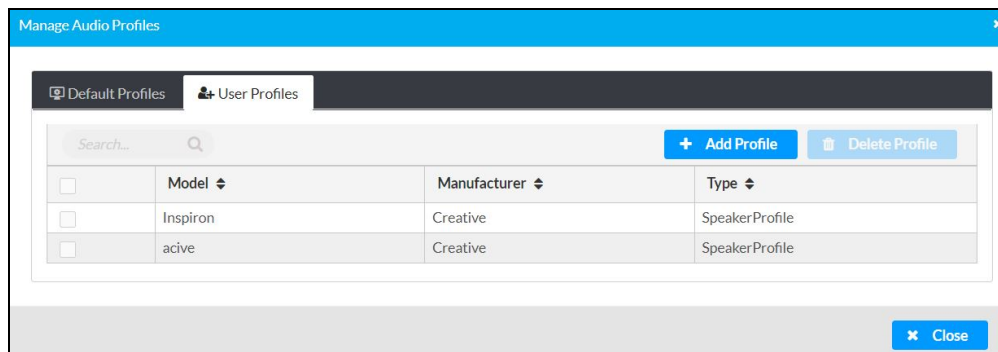

1. Select the **User Profiles** tab.
2. Select **+ Add Profiles**.
3. Select **+ Browse**.
4. Locate and select the .prof file, then select **Open**.
5. Select **Upload**.

6. Select **OK**. This will add the profile to the list box.

The speaker profile is now available for selection and can be applied to the speaker.

To Delete a Speaker Profile

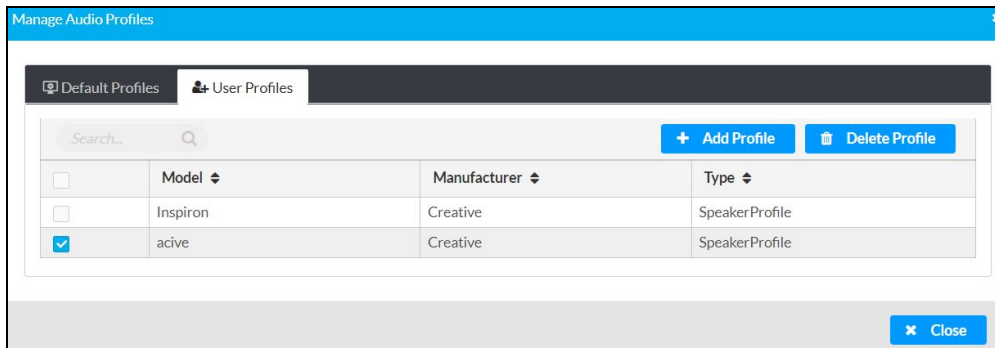

1. Select the **User Profiles** tab.
2. Select the checkbox corresponding to the audio profile that needs to be deleted.
3. Select **Delete Profile**.

The speaker profile is deleted.

Download Configuration

Select **Download Configuration** to download a TGZ file containing the settings data for the DM NAX device.

NOTE: User accounts for accessing the device, streaming service accounts, multicast addresses, and stream names are not saved in this configuration file.

Upload Configuration

1. Select **Upload Configuration** to upload a TGZ file that will overwrite the current settings of the DM NAX device with a saved configuration.

CAUTION: Be sure to load a TGZ file for the same DM NAX device type while using the Load Configuration feature. For example, if loading a TGZ file to a DM-NAX-16AIN, be sure that the TGZ file originated from a DM-NAX-16AIN.

2. Select **Browse** to navigate to the desired TGZ file in your file browser. Select the file. then select **Open**.

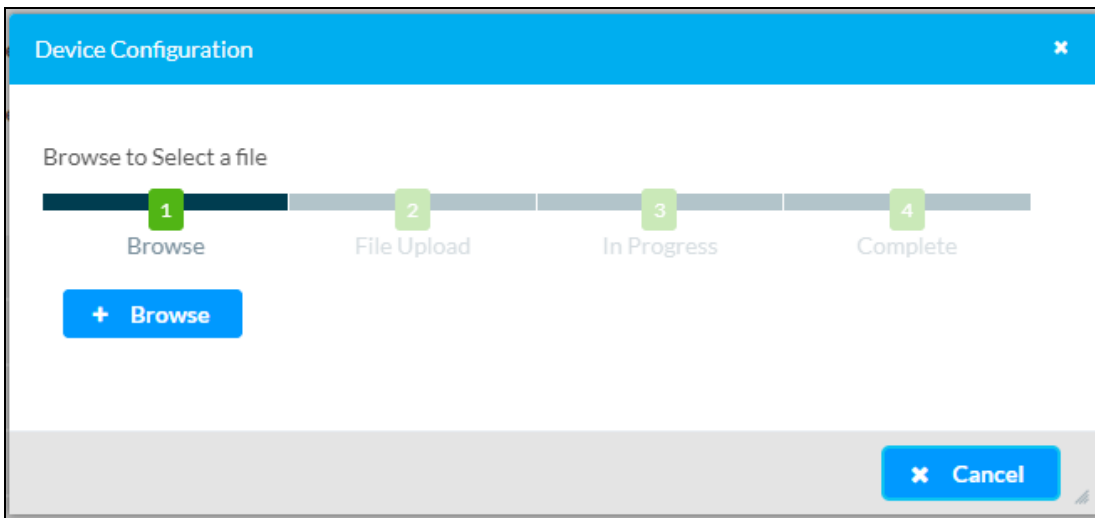

3. Select **Upload** to begin the file upload process. A progress bar will indicate the status of the configuration file upload.

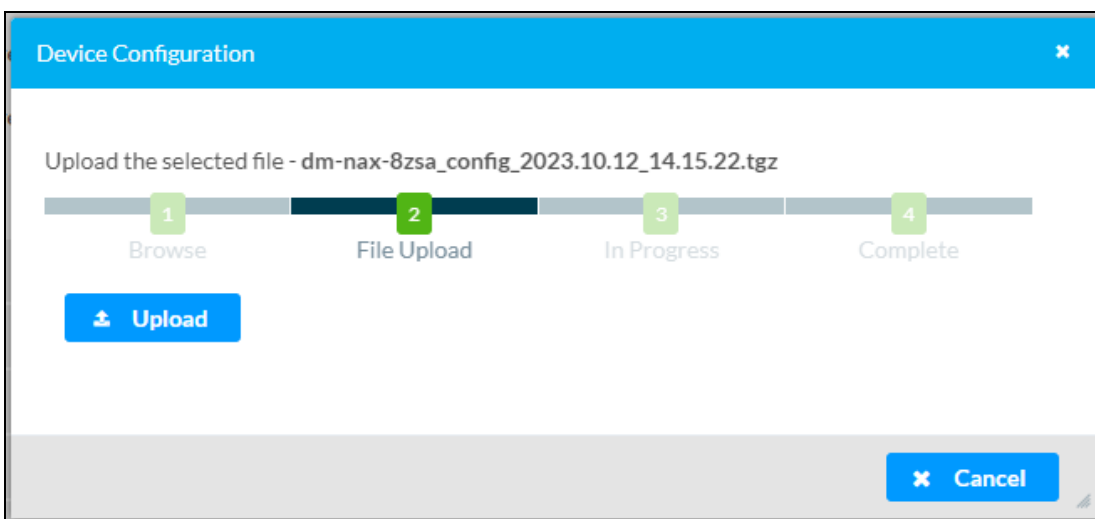

- Once the upload is complete, the device will require a reboot. Select **Yes, Reboot Now** to begin the reboot, or select **No** to return to the web UI.

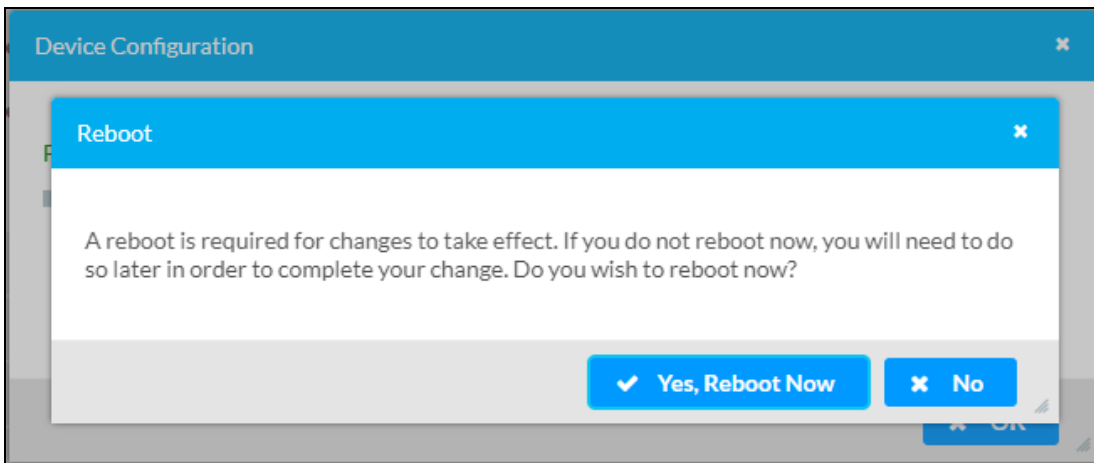

NOTE: Any changes made after the configuration file upload, but before a device reboot, may be overwritten when the device is rebooted.

Status

The **Status** page is the first page displayed when opening the interface of the DM-NAX-4ZSP. It displays general information about the DM-NAX-4ZSP (such as **Model Name**, **Firmware Version**, and **Serial Number**), current network settings (such as **Host Name** and **IP Address**, etc.), and input and output ports' current status.

The **Status** page can be accessed at any time by selecting the **Status** tab of the DM-NAX-4ZSP interface.

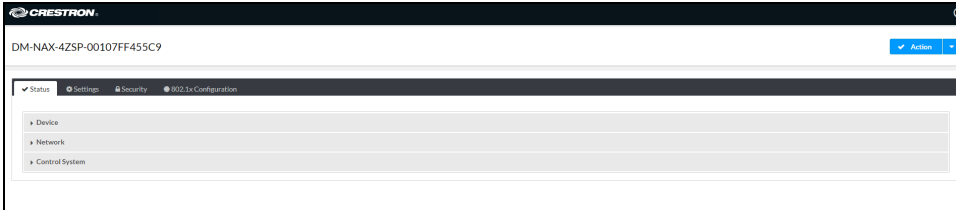

Information displayed on the **Status** tab is organized into different sections.

Device

The **Device** section displays the **Model**, **Firmware Version**, and **Serial Number** of the DM-NAX-4ZSP.

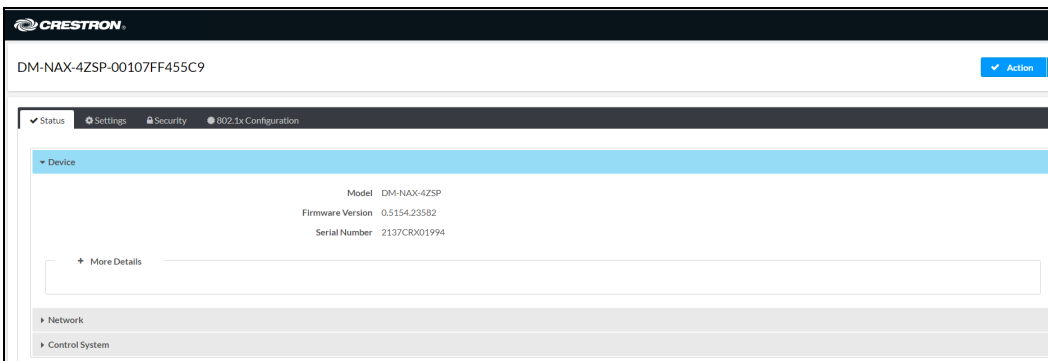

Select **+ More Details** to review additional information about the DM-NAX-4ZSP.

- More Details	
DM-NAX-4ZSP	0.5154.23582
Build	Feb 11 2022 (449289)
Updater	0.5154.23582
Bootloader	0.04.00
CCUI Version	1.602.877345
XIOSDK	3.8.0
IoTSDK	1.6.0
Build time	00:18:24
Product ID	0x7AFF
Revision ID	0x0400
ctrl-audio-dsp-0	FW v38 (Driver v3.9)
ctrl-audio-dsp-1	FW v38 (Driver v3.9)
ctrl-audio-fpga	FW v0.25 (Driver v1.2)
ctrl-sigma-dsp-0	FW v1.00 (Driver v1.1)
ctrl-sigma-dsp-1	FW v1.00 (Driver v1.1)
ctrl-hps-fpga	FW v1.20.2433093 (Driver v2.1)
PUF	Unknown
Forced Auth Mode	True

Network

The **Network** section displays network-related information about the DM-NAX-4ZSP, including the Hostname, Domain Name, and DNS Servers.

▼ Network	
Hostname	DM-NAX-4ZSP-00107FF455C9
Domain Name	crestronqelab.com
Primary Static DNS	10.254.64.12(DHCP)
Secondary Static DNS	192.168.200.133(DHCP)
- Adapter 1	
DHCP	On
IP Address	10.254.68.109
Subnet Mask	255.255.255.0
Default Gateway	10.254.68.1
Link Active	true
MAC Address	00.10.7f.f4.55.c9

NOTE: By default, the host name of the DM-NAX-4ZSP consists of the model name followed by the MAC address of the device. For example, DM-NAX-4ZSP-00107FF455C9.

Select **+ Adapter 1** to display an expanded section that shows additional information. If **+ Adapter 1** is selected, select **- Adapter 1** details to collapse the section.

NOTE: The + **Adapter 2** option appears when the dual Ethernet ports on the DM-NAX-4ZSP are set to isolate traffic using the Port Selection feature.

Control System

The **Control System** section displays connection information, consisting of the following:

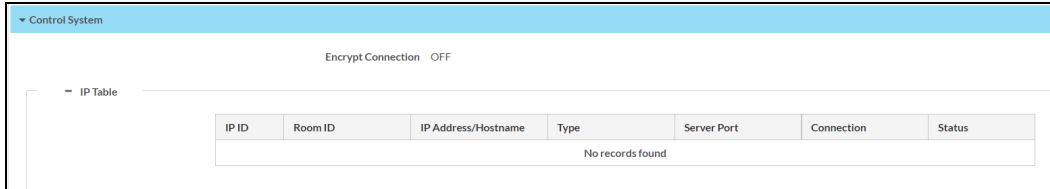

The screenshot shows a web interface for the Control System. At the top, there is a blue header with the text "Control System". Below the header, there is a toggle switch for "Encrypt Connection" which is currently set to "OFF". Underneath, there is a section titled "IP Table" which contains a table with the following columns: IP ID, Room ID, IP Address/Hostname, Type, Server Port, Connection, and Status. The table is currently empty, displaying the message "No records found".

- **Encrypt Connection:** ON or OFF
- **IP ID:** Reports the currently used IP ID of the DM-NAX-4ZSP
- **IP Address/Hostname:** The IP address of the control system
- **Room ID:** Displays the room ID
- **Status:** OFFLINE or ONLINE

Settings

The **Settings** page enables you to configure the DM-NAX-4ZSP settings. The **Settings** page can be accessed at any time by selecting the **Settings** tab of the DM-NAX-4ZSP interface.



Settings available on the **Settings** page are organized into different sections.

System Setup

The **System Setup** section contains settings for **Date/Time**, **Auto Update**, **Network**, and **Control System**.

Date/Time

Use the **Date/Time** section to configure the date and time settings of the DM-NAX-4ZSP.

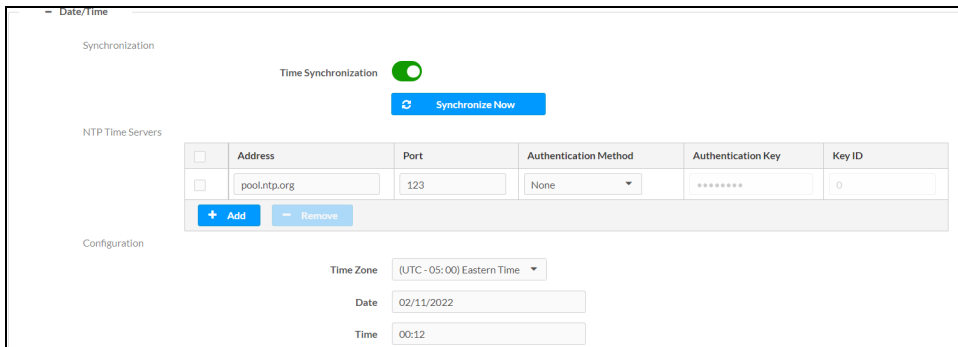

Time Synchronization

1. Set the **Time Synchronization** toggle to the right position to enable or left position to disable time synchronization. By default, time synchronization is enabled.
2. In the **NTP Time Servers** table, enter the URL of a NTP (Network Time Protocol) or SNTP (Simple Network Time Protocol) server. Up to three time servers can be added on a device.
3. Select **Synchronize Now** to perform time synchronization between the device's internal clock and the time server.

Time Configuration

1. Open the **Time Zone** drop-down menu to select the applicable time zone.
2. In the **Date** field, enter the current date.
3. In the **Time (24hr Format)** field, enter the current time in 24-hour format.

Select **Save Changes** to save the settings.

Select **Revert** from the **Action** drop-down menu to revert to the previous settings without saving.

Auto Update

The DM-NAX-4ZSP can automatically check for and install firmware updates at scheduled intervals via the **Auto Update** feature.

Auto Update

Auto Update

Custom URL

Custom URL Path

Schedule

Day of Week

Time of Day

Poll Interval Minutes

Update Now

1. Set the **Auto Update** toggle to the right position to enable Auto Update.
2. Define the URL to download the updates by doing either of the following:
 - a. Use the default URL to download the updates from the Crestron server.
 - b. Use a custom URL. Set the **Custom URL** toggle to the right position to enable a custom URL. In the **Custom URL Path** text box, enter the path to a custom manifest file in the FTP or SFTP URL format. Use the Crestron Auto Update Tool to generate a custom manifest file, then store the file on an FTP (File Transfer Protocol) or SFTP (Secure File Transfer Protocol) server.
3. Set a schedule for the automatic firmware update by doing either of the following:
 - a. Select the desired **Day of Week** and **Time of Day** (24-hour format) values.
 - b. Set the **Poll Interval** by entering a value from **60** to **65535** minutes. A value of **0** disables the Poll Interval.
4. Select **Save Changes**.

Selecting **Update Now** causes the device to check for a firmware update immediately. If a schedule was set in step 4 above, that schedule still remains in effect.

Network

The **Network** section contains network-related settings for the DM-NAX-4ZSP, including the **Hostname**, **Domain**, **Primary Static DNS**, and **Secondary Static DNS**.

▼ Network	
Hostname	DM-NAX-4ZSP-00107FF455C9
Domain Name	crestronqelab.com
Primary Static DNS	10.254.64.12(DHCP)
Secondary Static DNS	192.168.200.133(DHCP)
- Adapter 1	
DHCP	On
IP Address	10.254.68.109
Subnet Mask	255.255.255.0
Default Gateway	10.254.68.1
Link Active	true
MAC Address	00.10.7f.f4.55.c9

NOTE: By default, the hostname of the DM-NAX-4ZSP consists of the model name followed by the MAC address of the device. For example, DM-NAX-4ZSP-00107FB58088.

Adapter 1

The Adapter 1 subheading contains settings for DHCP, IP Address, Subnet Mask, and Default Gateway of Ethernet adapter 1 on the rear panel of the device.

NOTES:

- An **+ Adapter 2** option only appears when the dual Ethernet ports on the DM-NAX-4ZSP are set to isolate traffic using the Port Selection feature. The settings for Adapter 2 are identical to those available for Adapter 1.
- DM NAX devices' internal processes use IP addresses in the 10.10.10.xxx range. This IP range should be avoided when addressing DM NAX devices to prevent conflicts.

Set the **DHCP** toggle to enabled (right) or disabled (left) to specify whether the IP address of the DM-NAX-4ZSP is to be assigned by a DHCP (Dynamic Host Configuration Protocol) server.

- **Enabled:** When DHCP is enabled (default setting), the IP address of the DM-NAX-4ZSP is automatically assigned by a DHCP server on the local area network (LAN).
- **Disabled:** When DHCP is disabled, manually enter information in the following fields:
 - **Primary Static DNS:** Enter a primary DNS IP address.
 - **Secondary Static DNS:** Enter a secondary DNS IP address.
 - **IP Address:** Enter a unique IP address for the DM-NAX-4ZSP.
 - **Subnet Mask:** Enter the subnet mask that is set on the network.
 - **Default Gateway:** Enter the IP address that is to be used as the network's gateway.

To save any new network entries, select **Save Changes**.

Control System

The screenshot shows the 'Control System' configuration page. At the top, there is a blue button labeled 'Encrypt Connection'. Below it, the 'IP Table' section contains a table with four columns: 'IP ID', 'IP Address/Hostname', and 'Room ID'. The table has four rows of data. At the bottom of the table, there are two buttons: '+ Add' and 'x Remove'.

<input type="checkbox"/>	IP ID	IP Address/Hostname	Room ID
<input type="checkbox"/>	12	10.88.17.15	23
<input type="checkbox"/>	13	10.88.87.13	23
<input type="checkbox"/>	99	10.88.12.17	22
<input type="checkbox"/>	8B	CP4-R-00107FB9E0CC	Room ID

1. Select **Encrypt Connection** to navigate to the **Security** tab to configure encryption settings.
 - a. Enter the username in the **Control System Username** field.
 - b. Enter the password in the **Control System Password** field.
2. Select **+ Add** to add an IP table entry to the **IP Table**.
 - a. Enter the Room ID in the **Room ID** field.
 - b. Enter the IP ID of the DM-NAX-4ZSP in the **IP ID** field.
 - c. Enter the IP address or hostname of the control system in the **IP Address/Hostname** field.
3. Select **Save Changes** to save the new entries. The **Control System Save** message box appears, indicating that the control system settings were saved successfully. Select **Revert** to revert to the previous settings without saving.

Commissioning

The **Commissioning** section provides a quick way to automatically assign multicast addresses to all of the device's internal audio-over-IP stream transmitters.

The screenshot shows the 'Commissioning' section. It features two input fields: 'Starting Multicast Address' with the value '239.8.3.5' and 'Last Used Multicast Address' with the value '239.8.3.36'. Below these fields is a blue button labeled 'Assign Addresses'.

Select **Assign Addresses** to give each DM NAX transmitter in the DM-NAX-4ZSP a unique multicast address beginning with the specified **Starting Multicast Address**. The valid range for **Starting Multicast Address** is 239.8.0.0 to 239.255.255.239.

NOTE: This will begin transmitting multicast traffic on your network. Refer to [Audio-over-IP Network Design on page 632](#) for details on proper audio-over-IP network management.

Chimes

The **Chimes** section allows the built-in chime files to be assigned to any of the output zones on the device.

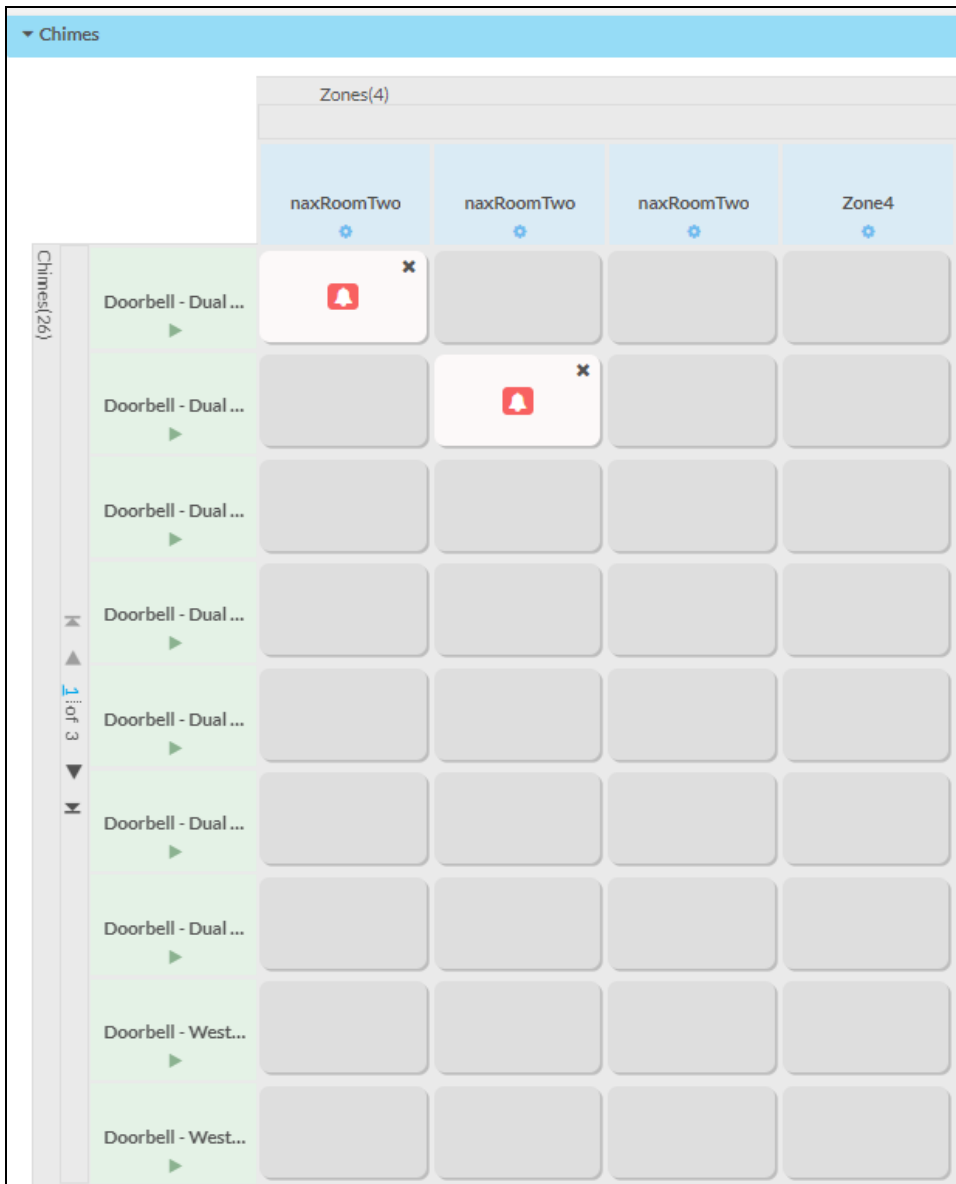

For each chime file, select the cells corresponding to the desired Zones for playback of that specific chime sound. You can assign multiple chimes to the same zone. To view all available chimes, use the ▲ or ▼ arrows at the left of the matrix to change pages.

To configure the chime volume of a zone:

1. Select the  icon corresponding to the zone. A **Configure** window appears.

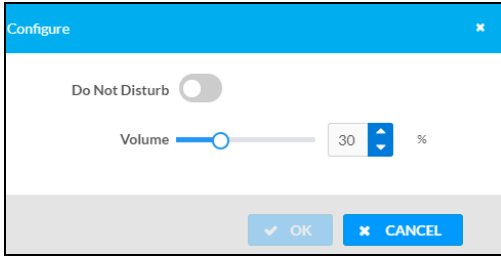

2. To set the volume, do one of the following:
 - Move the **Volume** slider to the right to increase or to the left to decrease the chime volume.
 - Use the **%** arrows to increase or decrease the chime volume. Values range from 0 to 100%, adjustable in increments of 1%.
 - Manually enter a value in the **Volume** field.

NOTE: The chime volume is independent of the zone volume control.

3. Set the **Do Not Disturb** toggle to the right to mute all chimes for the zone. Set the **Do Not Disturb** toggle to the left to unmute the chimes.
4. Select **OK** to apply the new settings.

Zones

The **Zones** section contains the **Volume** and **Mute** settings for all zone outputs of the device, as well as a Configure option for more advanced settings within each zone.

Name	Volume	Mute	Action
Zone_01	30 %	Mute	Configure
Zone_02	30 %	Mute	Configure
Zone_03	30 %	Mute	Configure
Zone_04	30 %	Mute	Configure

Give each zone a friendly name using the **Name** column of the **Zones** table. If the device is paired with a control system, these names may be overwritten by the control system's program.

To configure the zone volume, do one of the following:

- Move the **Volume** slider to the right to increase or to the left to decrease the zone volume.
- Use the **%** arrows to increase or decrease the zone volume. Values range from 0 to 100%, adjustable in increments of 1%.
- Manually enter a value in the **Volume** field.

To mute all audio output from a zone, select its respective **Mute**. To unmute the zone, select **Muted**.

Zone Settings

To configure zone settings, select **Configure** ( **Configure**). The **Edit Zone** window appears.



Zone

Select **Zone** to configure **Tone (Autosaved)**, **Balance (Autosaved)**, and **Delay (Autosaved)**.

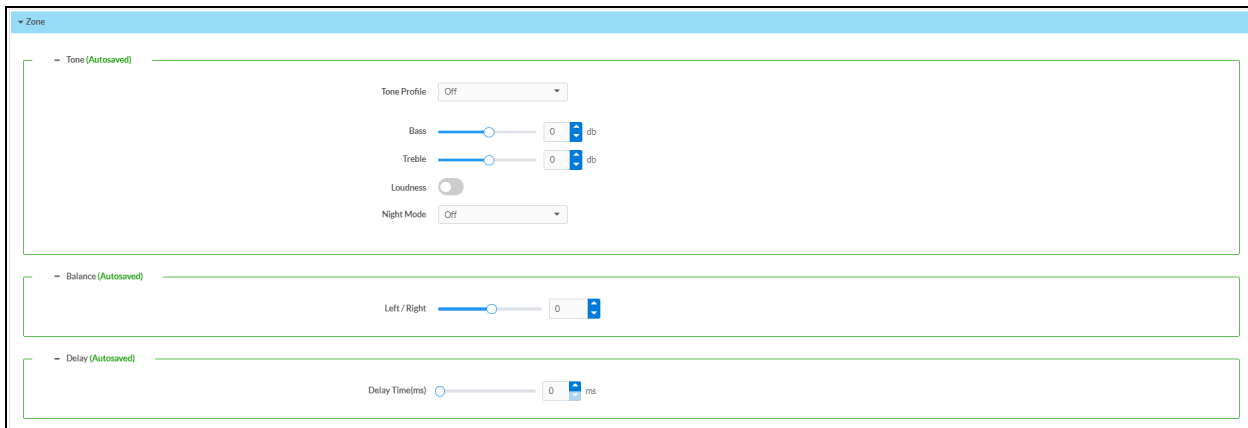

Tone

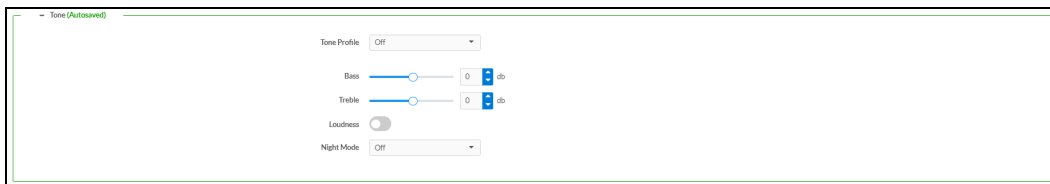

The **Tone** section provides adjustments for the **Tone Profile**, **Bass**, **Treble**, **Loudness**, and **Night Mode** settings of the zone output.

NOTE: The Tone Profile, Bass, Treble, and Loudness settings in the Tone section are all applied separately from the Equalizer Settings for the zone. This means that any adjustments made in the Tone section will stack with those made in the Equalizer Settings section.

1. To select a tone profile preset for the zone, select an option from the **Tone Profile** drop-down menu. The available options are **Off**, **Classical**, **Jazz**, **Pop**, **Rock**, and **Spoken Word**. By default, **Off** is selected.
2. **Bass**: To adjust the bass, do one of the following:
 - Move the **Bass** slider to the right to increase or to the left to decrease the bass.
 - Use the **db** arrows to increase or decrease the bass level. Values range from -12 dB to 12 dB, adjustable in increments of 1 dB.
 - Manually enter a value in the **Bass** field.
3. **Treble**: To adjust the treble, do one of the following:
 - Move the **Treble** slider to the right to increase or to the left to decrease the treble.
 - Use the **db** arrows to increase or decrease the treble level. Values range from -12 dB to 12 dB, adjustable in increments of 1 dB.
 - Manually enter a value in the **Treble** field.
4. To enable the loudness setting on the zone output, slide the **Loudness** switch to the right. To disable loudness, slide the **Loudness** switch to the left.
5. The **Night Mode** feature applies subtle processing to restrict the dynamic range of the zone audio, to allow for lower listening levels at night or in rooms where higher listening levels would be disruptive. To select a dynamics processing level, select an option from the **Night Mode** drop-down menu. The available options are **Off**, **Low**, **Medium**, and **High**. By default, **Off** is selected.

Balance

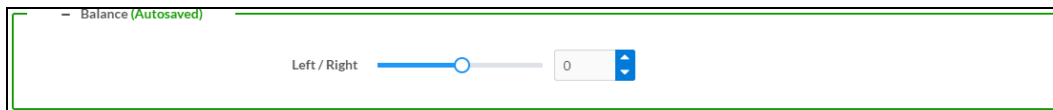

To adjust the left/right balance of the stereo output signal, do one of the following:

- Move the **Balance** slider to the right to shift the stereo balance to the right channel or to the left to shift the balance to the left.
- Use the arrows to adjust the balance left or right. The up arrow shifts the balance to the right while the down arrow shifts the balance to the left.
- Manually enter a value in the **Balance** field. Values range from -50 to 50, adjustable in increments of 1. Positive values shift the balance to the right while negative values shift the balance to the left.

Delay

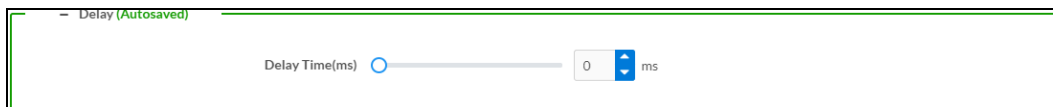

To set the delay, do one of the following:

- Move the **Delay Time(ms)** slider to the right to increase or to the left to decrease the delay time.
- Use the **ms** arrows to increase or decrease the delay. Values range from 0 ms to 250 ms,

adjustable in increments of 1 ms.

- Manually enter a value in the **Delay Time(ms)** field.

Output

Select **Output** to access the settings for **Minimum/Maximum Volume, Stereo/Mono, Signal, Bussing Volume Offset, Configure Speaker Profile, Speaker Configuration, Casting, Line Out, Signal Generator, Advanced Signal Generator, and Equalizer Settings.**

The screenshot shows the 'Output' settings menu. It is divided into three sections: 'Minimum / Maximum (Autosaved)', 'Stereo / Mono (Autosaved)', and 'Signal (Autosaved)'. The first section contains three sliders: 'Minimum' (set to 0%), 'Maximum' (set to 100%), and 'Default' (set to 30%). The second section has radio buttons for 'Stereo' (selected) and 'Mono', and a 'Zone Configuration' dropdown menu set to 'Standard'. The third section shows 'Signal' as 'Not Present'.

Minimum/Maximum Volume

The screenshot shows the 'Minimum / Maximum (Autosaved)' settings. It features three sliders: 'Minimum' (set to 14%), 'Maximum' (set to 86%), and 'Default' (set to 27%). Each slider has a corresponding percentage value and a small arrow icon to the right.

1. To set the minimum volume of the zone, do one of the following:
 - Move the **Minimum** slider to the right to increase or to the left to decrease the minimum volume.
 - Use the **%** arrows to increase or decrease the minimum volume. Values range from 0 to 50%, adjustable in increments of 1%.
 - Manually enter a value in the **Minimum** field.
2. To set the maximum volume of the zone, do one of the following:
 - Move the **Maximum** slider to the right to increase or to the left to decrease the maximum volume.
 - Use the **%** arrows to increase or decrease the maximum volume. Values range from 70 to 100%, adjustable in increments of 1%.
 - Manually enter a value in the **Maximum** field.

NOTE: When a **Minimum** and **Maximum** volume are set, the 1-100% range represented by the **Zone** and **Default** volume controls are scaled to the range set. For example, if a **Minimum** of 10% and a **Maximum** of 80% are set for a zone, the 1-100% range of the **Zone** volume control is scaled to the 10%-80% range set as the **Minimum** and **Maximum**.

3. To set the default volume of the zone, do one of the following:

- Move the **Default** slider to the right to increase or to the left to decrease the default volume.
- Use the **%** arrows to increase or decrease the default volume. Values range from 0 to 50%, adjustable in increments of 1%.
- Manually enter a value in the **Default** field.

NOTE: The **Default** volume is applied as the **Zone** volume any time the zone receives a source route and no source was previously routed to that zone.

Stereo/Mono

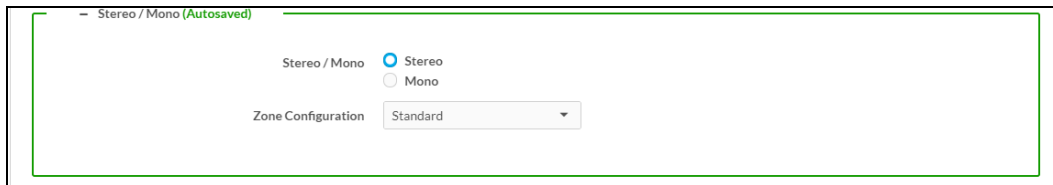

1. Select either **Stereo** or **Mono** from the **Stereo/Mono** field.

NOTE: The **Zone Configuration** field is reserved for future use on the DM-NAX-4ZSP. Currently, the only available value is **Standard**.

Signal

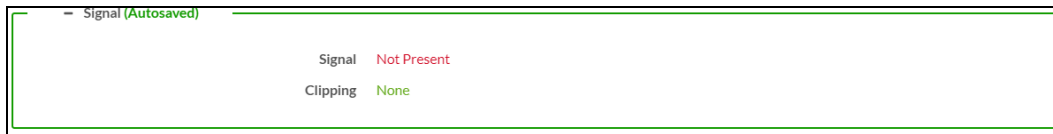

The **Signal** section is a read-only field that displays the **Signal** and **Clipping** status of the zone output.

- If an output signal is present but not clipping, **Signal** will display **Present** in green and **Clipping** will display **None** in green.
- If an output signal is present and clipping, **Signal** will display **Present** in green and **Clipping** will display **Present** in red.
- If no output signal is detected, **Signal** will display **Not Present** in red and **Clipping** will display **None** in green.

Bussing Volume Offset



Bussing Volume Offset is an additional level compensation applied to the zone relative to any other zones it is grouped with via the **Bussing** feature.

To set the bussing volume offset, do one of the following:

- Move the **Bussing Volume Offset** slider to the right to increase or to the left to decrease the offset.
- Use the **db** arrows to increase or decrease the offset. Values range from -12 dB to 12 dB, adjustable in increments of 1 dB.
- Manually enter a value in the **Bussing Volume Offset** field.

Configure Speaker Profile

The DM-NAX-4ZSP has a library of built-in speaker profiles that contain equalizer and maximum output level settings specific to Crestron and third-party speaker models. Custom speaker profiles can also be generated and loaded to the DM-NAX-4ZSP. The **Configure Speaker Profile** field is used to apply these speaker profiles to a given zone of the DM NAX device.

NOTE: Applying a speaker profile on a zone will overwrite the existing **Speaker Configuration** and **Equalizer** settings for that zone.

Applied Manufacturer Crestron
Applied Model SAROS ICE4

Global Filter

	Model ↕	Manufacturer ↕
<input type="radio"/>	Air LS4	Crestron
<input type="radio"/>	Air LS6	Crestron
<input type="radio"/>	Air SR4	Crestron
<input type="radio"/>	Air SR6	Crestron
<input type="radio"/>	Air SR8	Crestron

1 of 9

In the **Global Filter** field, enter the speaker's model name to search for its associated profile. Any speaker profiles matching the search criteria are displayed.

To apply a speaker profile:

1. Select a speaker profile.
2. Select **Apply**.

The equalizer, impedance, and speaker protection settings of the zone are updated as per the applied speaker profile.

After applying a speaker profile, the **Speaker Configuration** and **Equalizer** settings for the zone can still be edited. The **Configure Speaker Profile** section will display a notification if these settings were altered after the speaker profile was applied.



Speaker Configuration

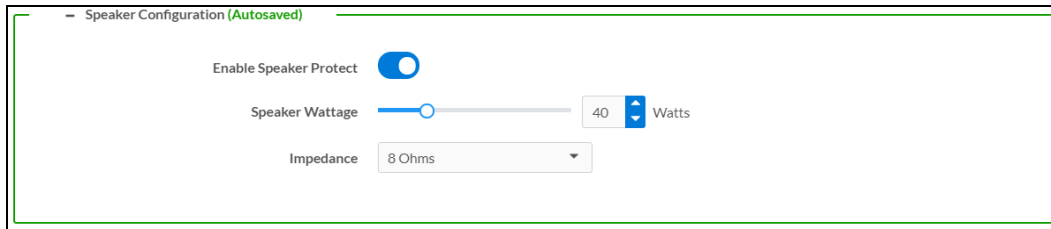

1. Set the **Enable Speaker Protect** toggle to the right position to enable speaker protection for the zone output. Set the toggle to the left position to disable speaker protection. By default, **Enable Speaker Protect** is set to the left position.
2. To set the maximum output wattage, do one of the following:
 - Move the **Speaker Wattage** slider to the right to increase or to the left to decrease the maximum peak amplifier wattage that can be output to the speaker.
 - Use the **Watts** arrows to increase or decrease the maximum peak amplifier wattage that can be output to the speaker. Values range from 5 W to 150 W, adjustable in increments of 1 W.
 - Manually enter a value in the **Speaker Wattage** field.

Casting

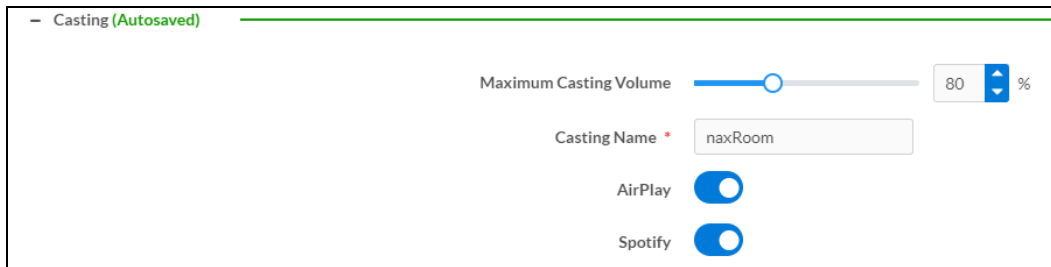

The Casting section is used to enable or disable the ability of third-party devices to cast audio to the DM NAX output zone, as well as set a maximum casting volume and friendly name for the zone.

To configure Casting:

1. **Maximum Casting Volume** is an alternate value for the **Maximum** volume set under [Minimum/Maximum Volume on page 327](#), applied to the zone only when a casting service is routed to it. To set the maximum casting volume, do one of the following:
 - Move the **Maximum Casting Volume** slider right to increase or left to decrease the maximum volume.
 - Use the arrows to increase or decrease the maximum casting volume. Values range from 70% to 100%, adjustable in increments of 1%.
 - Manually enter a value in the **Maximum Casting Volume** field.

NOTE: If the **Maximum Casting Volume** value is higher than the regular **Maximum** volume value, the **Maximum** value will be applied instead.

2. A custom casting name (for example, "Living Room") must be entered so that a name for the zone will be displayed in the list of available casting destinations when initiating a stream. Enter this friendly name in the **Casting Name** field.

NOTE: Ensure that the **Casting Name** field is populated as any field with an asterisk (*) is mandatory.

Once AirPlay® and/or Spotify Connect™ are enabled, this name will be displayed as an available destination on the casting device.

To configure Apple AirPlay® casting:

1. Set the **AirPlay** toggle to the right to enable AirPlay casting to the zone's associated media player. Set the **AirPlay** toggle to the left to disable AirPlay casting to the associated media player.

To configure Spotify Connect™ casting:

1. Set the **Spotify** toggle to the right to enable Spotify Connect casting to the zone's associated media player. Set the **Spotify** toggle to the left to disable Spotify Connect casting to the associated media player.

To stream media from an iOS device or Spotify app to a zone in your distributed audio system, refer to the [DM-NAX-4ZSP Quick Start](#).

To stream media from a Roon® streaming device to a zone in your distributed audio system:

1. Enable Apple AirPlay casting for each DM NAX zone.
2. Launch the Roon desktop app.
3. Open the Roon app menu and navigate to the **Settings** submenu, then select **Audio**. A table of discovered network devices that the Roon device can stream to will be displayed. Any devices that previously have been enabled for Roon casting are listed under the **Connected to Core** section, and the rest of the discovered devices are listed under **Other network devices**.
4. Find each of the DM NAX zones in the **Other network devices** list, then select **Enable** for each zone to connect it to the Roon Core® for casting.
5. Return to the Roon app home page and select the speaker icon at the bottom right. Select a DM NAX zone from the list of available casting destinations. With a zone selected, start a media stream, and the Roon device will cast the streaming audio to the zone.

Line Out

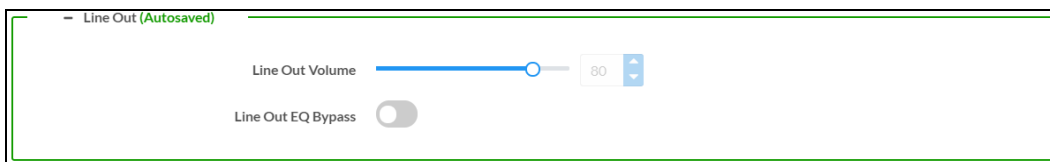

Line Out Volume controls the volume level of the corresponding line-level output on the DM NAX device. The Line Out Volume is only applied when **Line Out EQ Bypass** is enabled.

- To set the line out volume, do one of the following:
 - Move the **Line Out Volume** slider to the right to increase or to the left to decrease the line out volume.
 - Use the arrows to increase or decrease the line out volume. Values range from 0 to 100, adjustable in increments of 1. This range in dB is -80 dB to 20 dB.
 - Manually enter a value in the **Line Out Volume** field.
- Set the **Line Out EQ Bypass** toggle to the right position to have the line-level output signal bypass the zone's equalizer settings. Set the toggle to the left position to have the line-level output signal pass through the zone's equalizer. By default, **Line Out EQ Bypass** is disabled.

NOTE: When the **Line Out EQ Bypass** setting is disabled, the line-level output's level will follow the speaker output's **Zone** volume control. This allows for a variable line-level output in applications where the line-level output is connected to an uncontrolled device such as powered speakers. If the **Line Out EQ Bypass** setting is enabled, the **Line Out Volume** slider can be used to set a fixed level for the line-level output. This level will not be affected by the speaker output **Zone** volume controls, which is better suited to applications where the line output is connected to a controlled amplifier with its own level adjustment.

Signal Generator

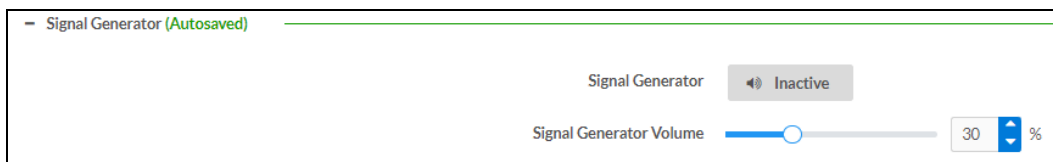

The DM-NAX-4ZSP has a built-in signal generator that allows an integrator to send an audio signal to any number of selected zones to test output functionality.

- To route the signal generator to the zone output, select **Signal Generator** so that it displays **Active** and is highlighted in blue. To unroute the signal generator on the zone output, select **Signal Generator** so that it displays **Inactive** and is highlighted in grey. By default, the signal generator is not routed to the zone output.

NOTES:

- There is only one signal generator built-in to the DM NAX device. Each zone has its own button to enable or disable the signal generator from passing signal to that output. Setting the signal generator to **Inactive** on a given zone output only breaks the route for that output and does not stop it from playing back in other zones.
- The **Signal Generator Volume** control is a local control that does not affect the signal generator's volume on other zone outputs. Only the settings under **Advanced Signal Generator** are applied universally to all zones of the DM NAX device.

2. To adjust the signal generator's volume, do one of the following:

- Move the **Signal Generator Volume** slider right to increase or left to decrease the volume.
- Use the arrows to increase or decrease the signal generator volume. Values range from 0 to 100, adjustable in increments of 1.
- Manually enter a value in the **Signal Generator Volume** field.

Advanced Signal Generator

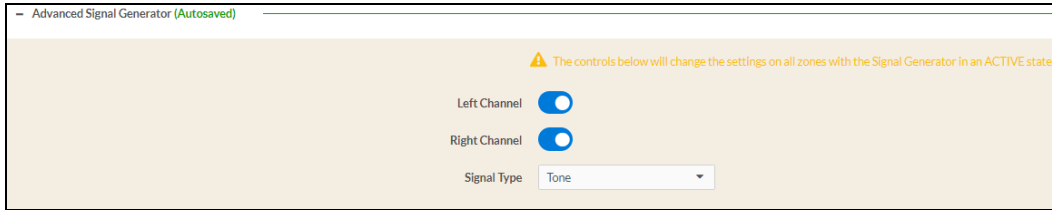

The advanced signal generator settings control the built-in signal generator directly, and are applied universally to all output zones of the DM NAX device. The signal type for the generator can be set, and the left and right channels of the test signal can be individually enabled or disabled.

1. Set the **Left Channel** toggle to the right position to enable the left channel of the signal. Set the toggle to the left position to disable the left channel. By default, **Left Channel** is enabled.
2. Set the **Right Channel** toggle to the right position to enable the right channel of the signal. Set the toggle to the left position to disable the right channel. By default, **Right Channel** is enabled.
3. Select an audio test signal type from the **Signal Type** drop-down menu. The available signal types are:
 - **Tone**: Generates a 1 kHz sine wave tone.
 - **Pink Noise**: Generates pink noise.
 - **White Noise**: Generates white noise.

Equalizer Settings

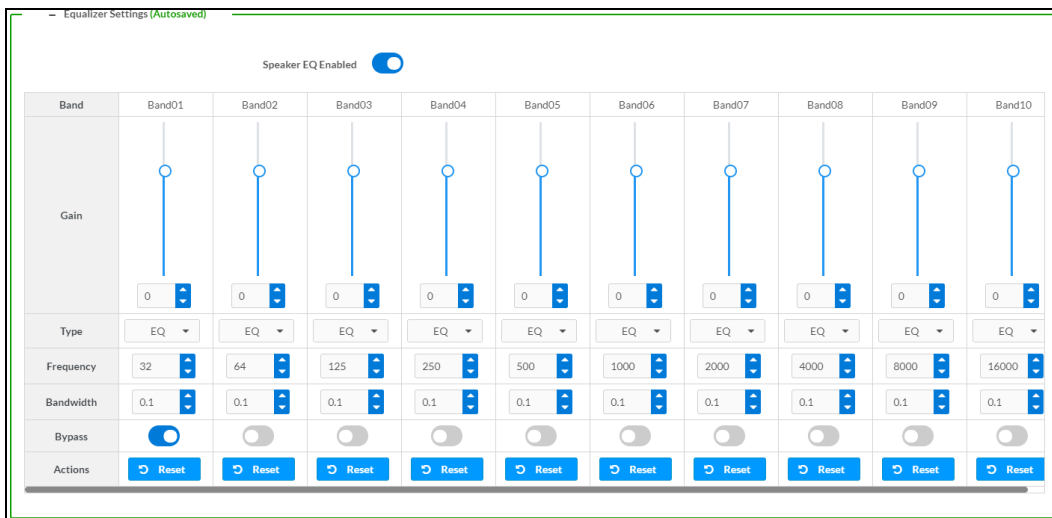

Each zone output of the DM-NAX-4ZSP has a dedicated ten-band equalizer that can be fully customized to tune the zone output signal to the needs of an install. Each band can have a discrete gain,

filter type, center frequency, and bandwidth set, and can also be bypassed. The equalizer itself can also be bypassed using the **Speaker EQ Enabled** toggle.

1. Set the **Speaker EQ Enabled** toggle to the right position to enable the equalizer. Set the toggle to the left position to bypass the equalizer.

NOTE: When **Speaker EQ Enabled** is disabled, all equalizer bands are bypassed. This is a quick way to perform A/B testing of the entire EQ curve.

2. With the **Speaker EQ Enabled** toggle in the right position, configure the equalizer bands.
 - a. To set a band's gain, do one of the following:
 - Move the **Gain** slider up to increase or down to decrease the gain.
 - Use the arrows to increase or decrease the gain. Values range from -40 dB to 20 dB, adjustable in increments of 0.1 dB.
 - Manually enter a value in the **Gain** field.
 - b. Select a filter type from the **Type** drop-down menu. By default, all bands are set to the **EQ** filter type. Some filter types will disable other settings in their respective band while enabled. For example, selecting the **LowPass** filter type for a band will disable that band's **Gain** and **Bandwidth** settings, since the **LowPass** filter applies a fixed roll-off slope at a set frequency. The available filter types are:
 - **EQ:** a fully parametric filter that can boost or cut a range of frequencies.
 - **Notch:** a parametric filter designed to more precisely cut a frequency or range of frequencies. A notch filter can achieve a narrower bandwidth than the standard **EQ** parametric filter type.
 - **TrebleShelf:** a filter that boosts or cuts all frequencies above a set frequency by a set gain.
 - **BassShelf:** a filter that boosts or cuts all frequencies below a set frequency by a set gain.
 - **LowPass:** a filter that fully cuts all frequencies above a set frequency using a fixed roll-off slope of -12 dB per octave.
 - **HighPass:** a filter that fully cuts all frequencies below a set frequency using a fixed roll-off slope of -12 dB per octave.
 - c. Set a center frequency for the equalizer band to tune a specific portion of the audible frequency spectrum. To set the center frequency, do one of the following:
 - Use the arrows to increase or decrease the frequency. Values range from 20 Hz to 20 kHz, adjustable in increments of 1 Hz. Each band has a default center frequency that will be applied if **Reset** at the bottom of the band is selected.
 - Manually enter a value in the **Frequency** field.
 - d. Set a bandwidth to determine how wide of a frequency range is effected by the equalizer band. To set the bandwidth, do one of the following:
 - Use the arrows to increase or decrease the bandwidth. Values range from 0.1 octaves to 4.0 octaves, adjustable in increments of 0.1 octave.
 - Manually enter a value in the **Bandwidth** field.

- e. The individual Bypass controls allow you to bypass a single band of equalization at a time for more granular A/B testing of a single filter. Set a band's **Bypass** toggle to the right position to bypass that band. Set the toggle to the left position to disable the bypass. By default, **Bypass** is disabled.
- f. Each equalizer band has a **Reset** that will reapply the default settings for that band.

Select **Done** to return to the **Settings** tab of the web user interface.

Bussing

The bussing feature on DM NAX devices allows an integrator to assign any number of selected zones to a fixed group of zones (bus). Zones in a bus track the other zones' volume and routing. For example, when the source or volume for one zone in the bus is adjusted, all other zones in that bus receive the same adjustment. You can create up to two buses on the DM-NAX-4ZSP.

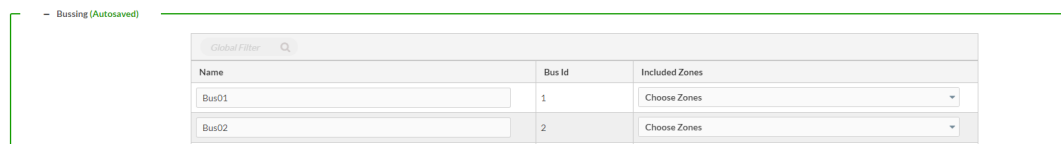

Configure Bussing

1. If needed, enter a friendly name for each bus in its **Name** field.
2. Select any number of zones from the **Included Zones** drop-down menu.

NOTE: Each zone can be a member of only one bus. Any zones that are already a member of another bus will not be shown in the **Included Zones** drop-down.

Inputs

The **Inputs** menu is used to configure **Name**, **Compensation**, and **Mute** attributes of the available analog, digital, and media streaming inputs on the DM-NAX-4ZSP.

A total of 12 inputs are available on the DM-NAX-4ZSP, including the 8 physical input connectors on the device's rear panel and the 4 internal media players used for media streaming services.

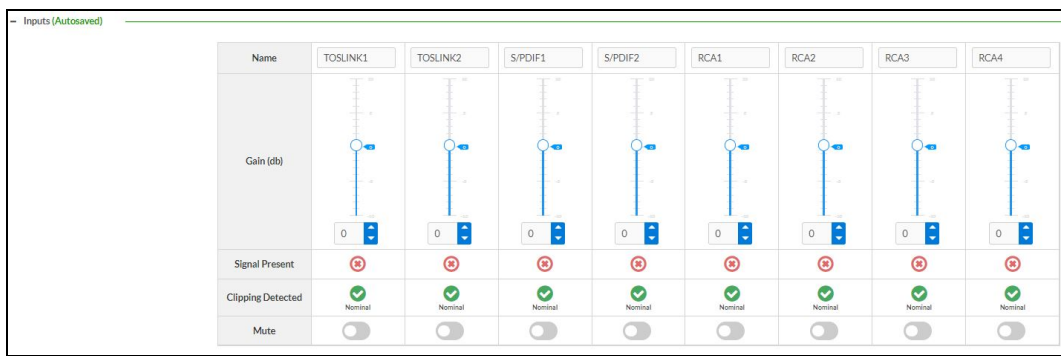

Configure Inputs

1. If needed, enter a friendly name for each input in its **Name** field.
2. To set a level compensation adjustment for a given input, do one of the following:
 - Move the **Compensation** slider up to increase or down to decrease the compensation. Compensation increases or decreases the level of the incoming audio signal on any of the physical inputs on the device's rear panel. Compensation is not available for any of the internal media players.
 - Use the **db** arrows to increase or decrease the compensation. Values range from -10 dB to 10 dB, adjustable in increments of 1 dB.
 - Manually enter a value in the **Compensation** field.
3. To mute the signal from the corresponding input, select **Mute**. To disable the mute, select **Muted**. By default, **Mute** is disabled.

Monitor the device's input signals using the text indicators in the **Signal Present** and **Clipping Detected** columns:

- **Signal Presence** indicates whether or not a signal is detected in that zone.
- **Clipping Detected** indicates if the signal is **Clipping** or **Nominal** (non-clipping).

Use the **Global Filter** text field to filter specific inputs by name. Not all of the available inputs are shown on the first page in this section when no **Global Filter** is applied. Use  at the bottom of the table to view the next page of inputs.

DM NAX Streams

Each local input of the DM-NAX-4ZSP can be made available as a DM NAX audio-over-IP stream. This includes the eight physical inputs on the rear panel of the device and the four internal media players.

The DM-NAX-4ZSP also supports parallel DM NAX streams for each zone output, enabling an additional transmit stream per output to mirror all routes and DSP settings of its respective zone. These parallel streams enable control of the audio signal to third-party uncontrolled AES67 devices receiving audio from the DM-NAX-4ZSP.

NOTES:

- Under the **Transmitters** section (see [Configure Transmitters](#)), the last four listed transmitters are dedicated to parallel zone outputs.
- To configure the DSP settings, see [Zone Settings](#).

Select **NAX Streams** to expand the tab and display the following information.

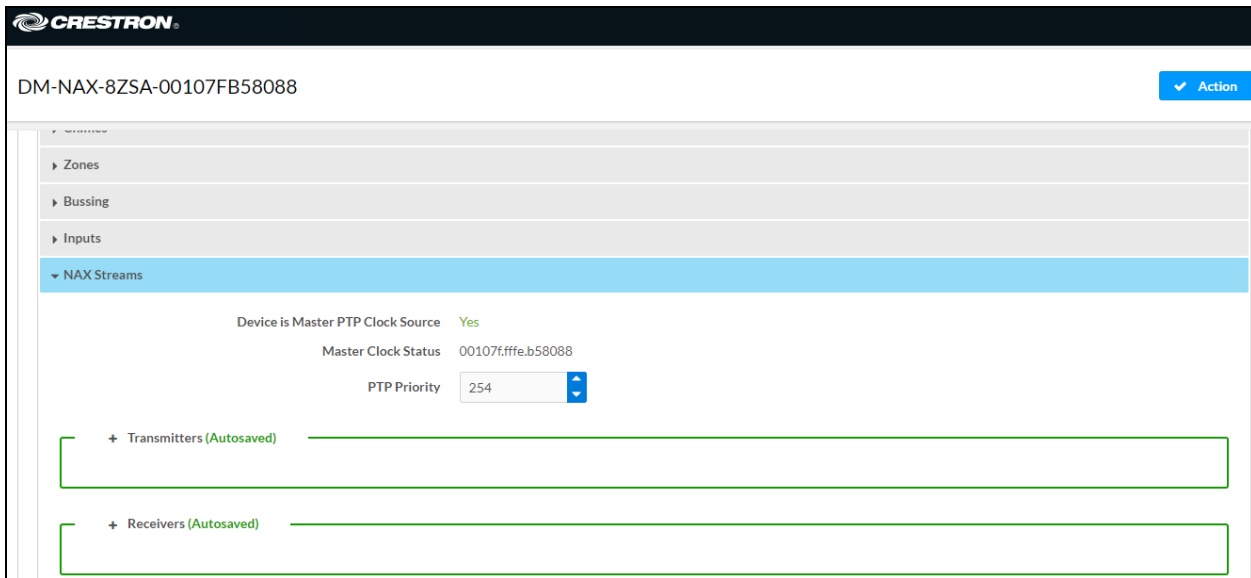

- **Device is Leader PTP Clock Source** indicates whether the device is the leader for PTP on the network. **Yes** will be displayed in green when the local DM-NAX-4ZSP is the PTP leader clock and **No** will be displayed in red when another PTP clock on the network is operating as the leader clock.
- **Leader Clock Status** displays the Leader Clock ID of the device on the network that acts as the Leader Clock.
- **PTP Priority:** This sets the priority of the local DM NAX device's PTP clock relative to other clocks on the network. The default setting is 254 (one increment higher than the lowest possible value) so that the DM-NAX-4ZSP will only operate as the leader clock if no other PTP leader is present on the network. Valid values range from 1 to 255-

Configure Transmitters

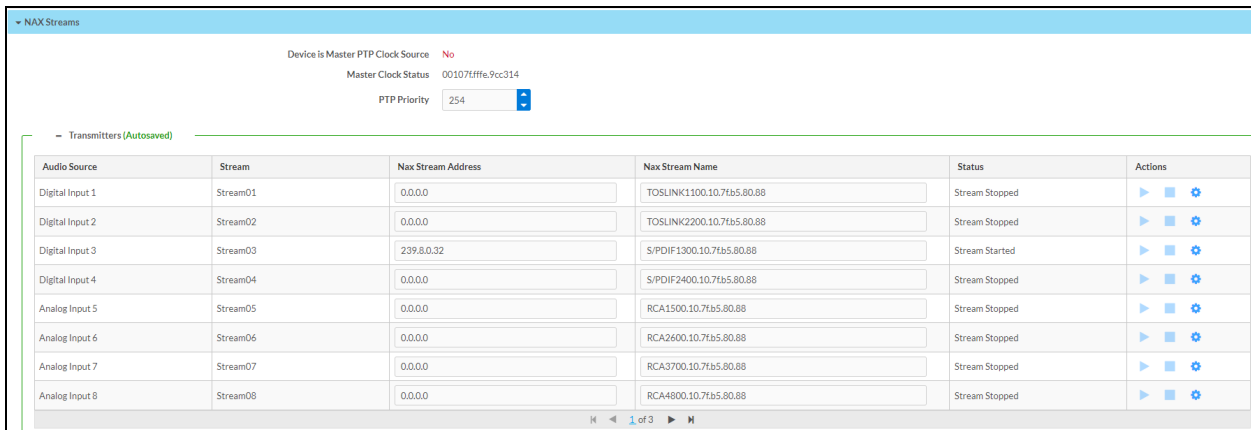

NOTE: To configure transmitters not shown on the current page of the table, select the ▶ icon to display the next page of eight transmitters.





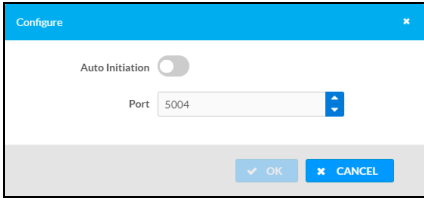



















To configure a DM NAX transmit stream:

1. Enter a valid multicast address in the **NAX Stream Address** field.
2. Enter a name in the **NAX Stream Name** field by which the stream can be identified. This stream name is associated with the DM NAX stream's multicast address by other DM NAX or AES67 devices, like a device hostname that resolves to a given IP address.
3. **Status** indicates whether a stream is transmitting or not. When the stream has started or stopped, the **Status** column will update accordingly.
4. Select the configure icon  in the **Actions** column. The **Configure** dialog appears:



5. Set the **Auto Initiation** toggle to the right position to enable auto initiation. Set the toggle to the left position to disable auto initiation.
 - If **Auto Initiation** is enabled for a given stream, the stream will begin transmitting automatically and will be available as a multicast stream on your network at the specified multicast address.
 - If **Auto Initiation** is disabled for the input, the stream will not begin transmitting until it is manually initiated.
6. To set the port number, do one of the following:
 - Use the arrows to increase or decrease the port number by increments of 1.
 - Manually enter a port number in the **Port** field. The default port number for DM NAX streams is 5004.
7. Select **OK** to save or select **Cancel** to cancel the changes.

Configure Receivers

Zone Name	Stream	Current Stream Address	Requested Stream Address	Status	Actions
Zone1	Stream01	0.0.0.0	0.0.0.0	Stream Stopped	  
Zone2	Stream02	0.0.0.0	0.0.0.0	Stream Stopped	  
Zone3	Stream03	0.0.0.0	0.0.0.0	Stream Stopped	  
Zone4	Stream04	0.0.0.0	0.0.0.0	Stream Stopped	  
Zone5	Stream05	0.0.0.0	0.0.0.0	Stream Stopped	  
Zone6	Stream06	0.0.0.0	0.0.0.0	Stream Stopped	  
Zone7	Stream07	0.0.0.0	0.0.0.0	Stream Stopped	  
Zone8	Stream08	0.0.0.0	0.0.0.0	Stream Stopped	  

1. Enter the multicast address of a transmitting stream in the **Requested Stream Address** field to subscribe the receiver to the stream.

2. Select the configure icon  in the **Actions** column. The **Configure** dialog appears:

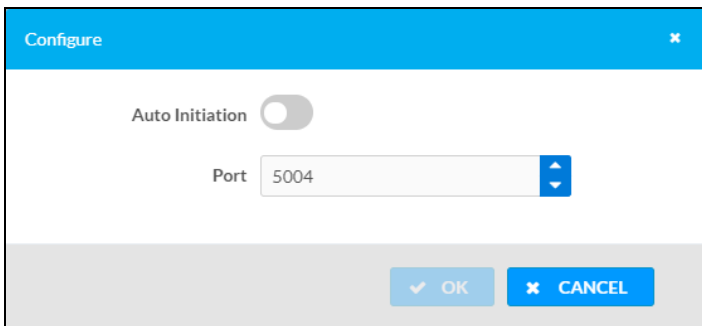

3. Set the **Auto Initiation** toggle to the right position to enable auto initiation. Set the toggle to the left position to disable auto initiation.

- If **Auto Initiation** is enabled, the stream will begin automatically when the receiver subscribes to the transmitter.
- If **Auto Initiation** is disabled, the stream will not begin until it is manually initiated.

4. To set the port number, do one of the following:

- Use the arrows to increase or decrease the port number by increments of 1.
- Manually enter a port number in the **Port** field. The default port number is 5004.





5. Select **OK** to save or select **Cancel** to cancel the changes.

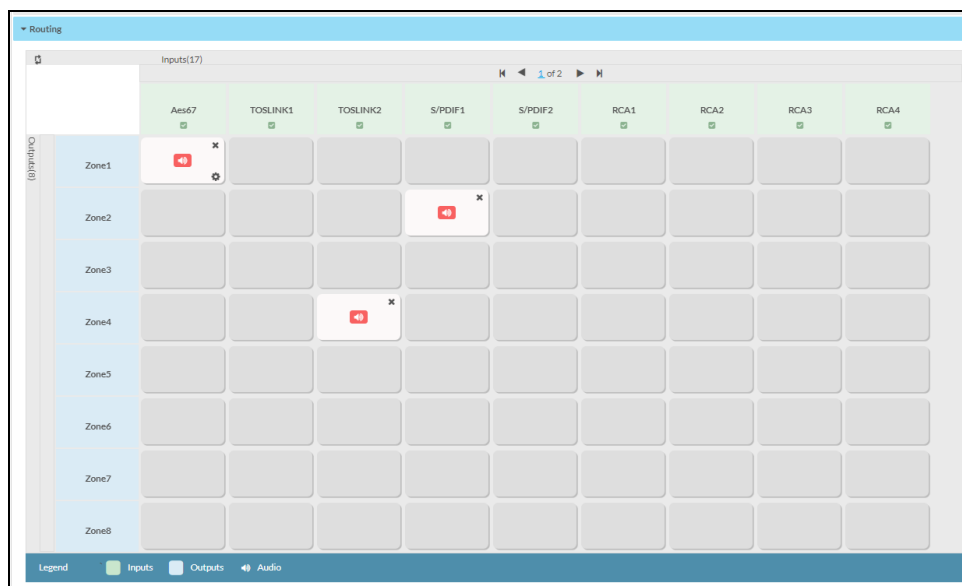

Routing

The **Routing** page is used to route a local input, media player, or AES67 stream to a Zone on the DM-NAX-4ZSP.

NOTE: To receive an AES67 stream from Dante devices, see [OLH 1001151](#).



- To route an input to a zone, select the box in the routing matrix where the zone's row overlaps the corresponding input's column. Once a route is made,  appears.
- To break a given route, select  or .
- To route a single input to all zones, select the  icon under the input's name.

Use the arrows ( or ) at the top of the matrix to change pages to view all available inputs.

To select a specific NAX/AES67 stream when AES67 is selected as the source for a zone:

- Select the gear icon  to display the list of all DM NAX/AES67 streams discovered on the network, then select the corresponding stream to be routed to the zone.

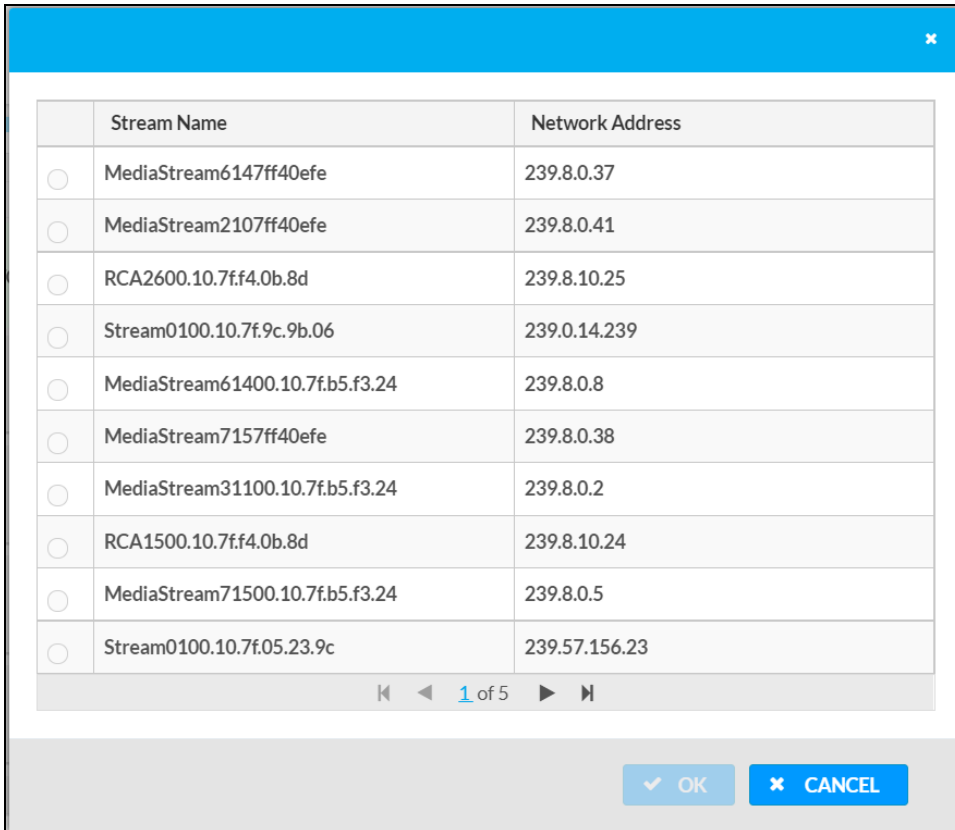

- Select **OK** to save or select **Cancel** to cancel the changes.

Streaming Services

The DM-NAX-4ZSP features four built-in media streaming players, each of which can play back a discrete media stream from a cloud-based service or local casting device. User Profiles can be created for each user of the DM NAX device with discrete credentials, enabling multiple users access to media streaming services without interfering with other users' recommendations, favorites, or playlists.

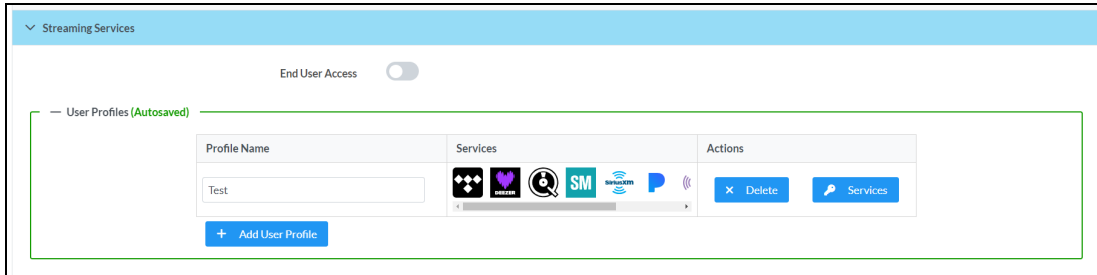

To configure Streaming Services:

1. Select **+ Add User Profile** to create a new user profile. Each user profile can contain a unique set of accounts for all supported streaming services.
2. Enter a name in the **Profile Name** field. Select **Save** to create the **User Profile**. Once the profile is created, you have the option to either **Delete** the profile, or add **Services** to it.
3. Select **Services** in the **Action** column and an **Edit Services** window appears.

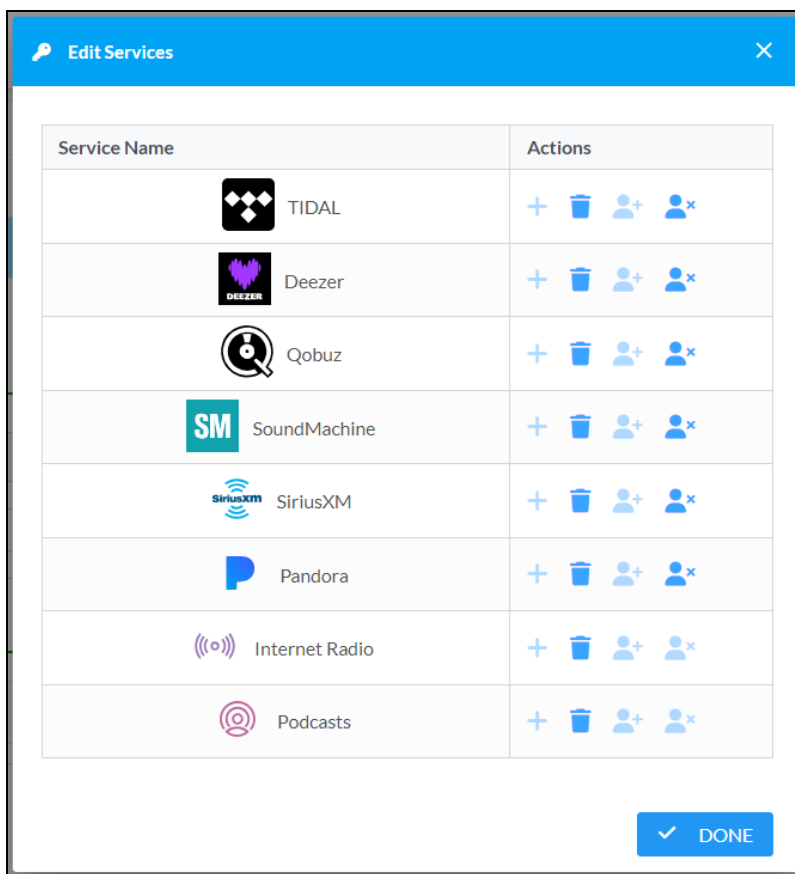

4. Select from the available Streaming Services: **TIDAL™**, **Deezer®**, **Qobuz®**, **SOUNDMACHINE®**, **SiriusXM®**, **Pandora®**, **Internet Radio**, and **Podcasts**. Select **+** or **🗑️** to add or delete the desired streaming services for each user profile.

User Authentication

User authentication is required for TIDAL, Deezer, Qobuz, SOUNDMACHINE, SiriusXM and Pandora. Select **+** to authorize the user.

To authenticate SiriusXM streaming:

NOTE: To determine whether to use commercial accounts, refer to the streaming service license agreement or FAQs on their respective portals. Refer to [this link](#) for SiriusXM documentation.

Enter the user credentials and select **OK**.

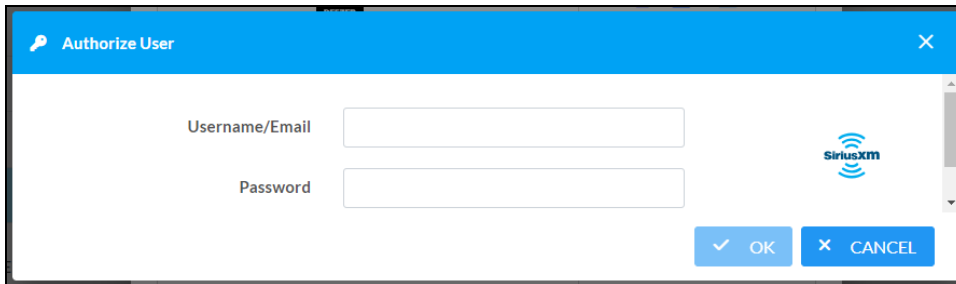

The screenshot shows a dialog box titled "Authorize User" with a blue header and a close button (X) in the top right corner. The main area contains two input fields: "Username/Email" and "Password". To the right of these fields is the SiriusXM logo. At the bottom right, there are two buttons: "OK" with a checkmark icon and "CANCEL" with an X icon.

To authenticate TIDAL streaming:

1. Select the link to log in to the TIDAL portal.

NOTE: The link is valid for one minute. After one minute, the link expires, and the **Authorize URL** is shown as blank. The **Authorize User** dialogue will need to be closed and reopened.

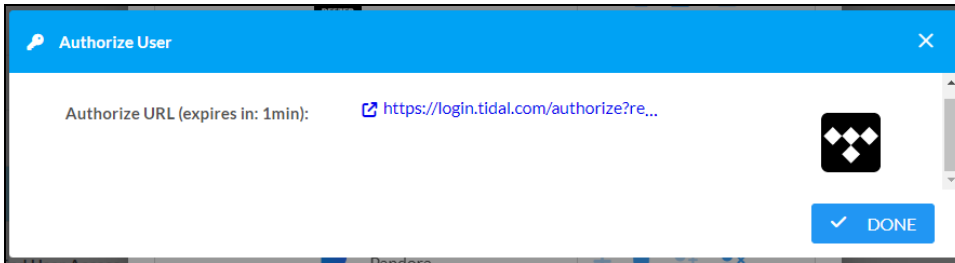

The screenshot shows a dialog box titled "Authorize User" with a blue header and a close button (X) in the top right corner. The main area contains the text "Authorize URL (expires in: 1min):" followed by a blue link icon and the URL "https://login.tidal.com/authorize?re...". To the right of the URL is the TIDAL logo. At the bottom right, there is a "DONE" button with a checkmark icon.

2. Select **DONE** to return to **Streaming Services**.

To authenticate Deezer streaming:

1. Select the link to log in to the Deezer portal.

NOTE: The link is valid for one minute. After one minute, the link expires, and the **Authorize URL** is shown as blank. The **Authorize User** dialogue will need to be closed and reopened.

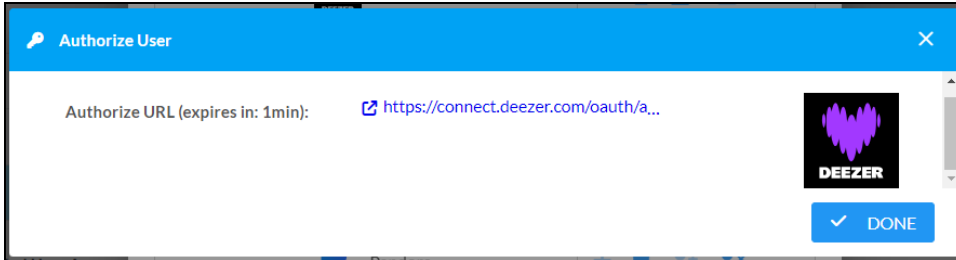

2. Select **DONE** to return to **Streaming Services**.

To authenticate Qobuz streaming:

1. Select the link to log in to the Qobuz portal.

NOTE: The link is valid for one minute. After one minute, the link expires, and the **Authorize URL** is shown as blank. The **Authorize User** dialogue will need to be closed and reopened.

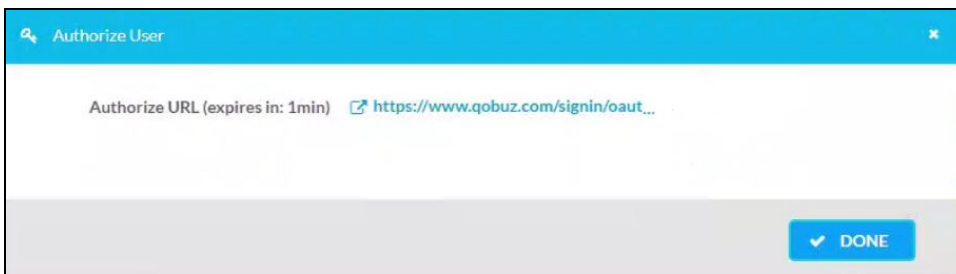

2. Select **DONE** to return to **Streaming Services**.

To authenticate SOUNDMACHINE streaming:

NOTE: To determine whether to use commercial accounts, refer to the streaming service license agreement or FAQs on their respective portals. Refer to [this link](#) for SOUNDMACHINE documentation.

1. Select the link to log in to the SOUNDMACHINE portal.

NOTE: The link is valid for one minute. After one minute, the link expires, and the **Authorize URL** is shown as blank. The **Authorize User** dialogue will need to be closed and reopened.

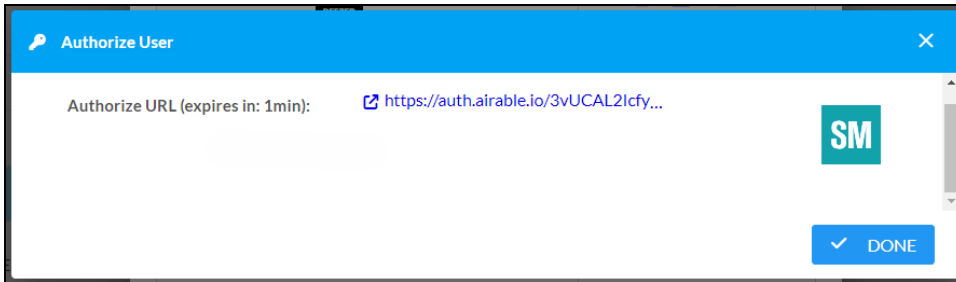

2. Log in to the SOUNDMACHINE account.

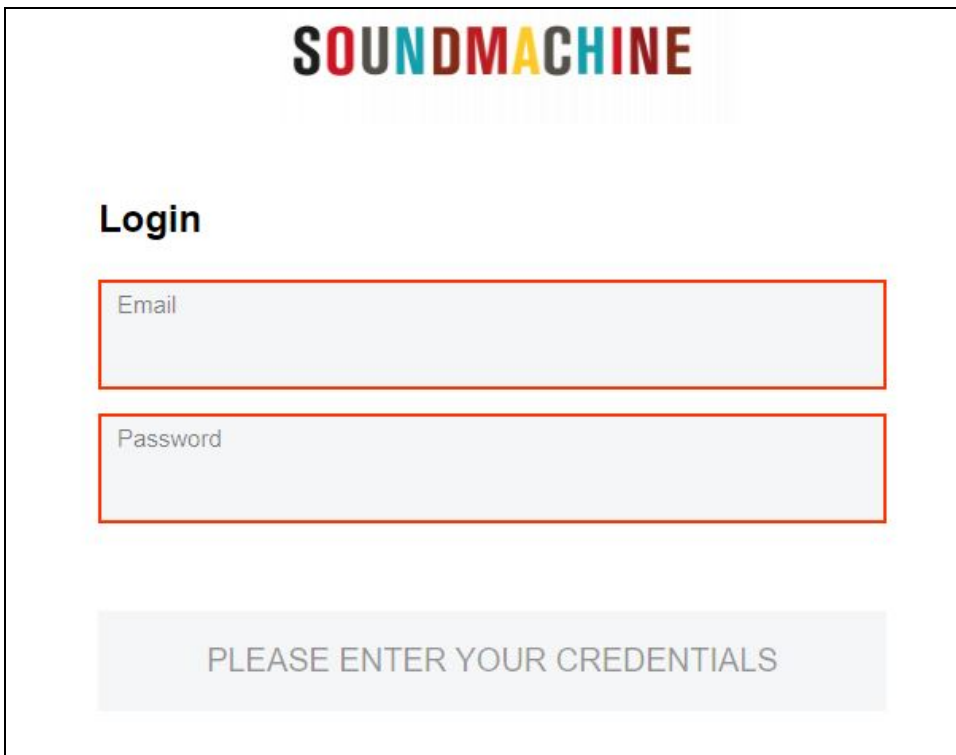

3. Select **DONE** to return to **Streaming Services**.

To authenticate Pandora streaming:

1. Select the  icon to copy the activation code.

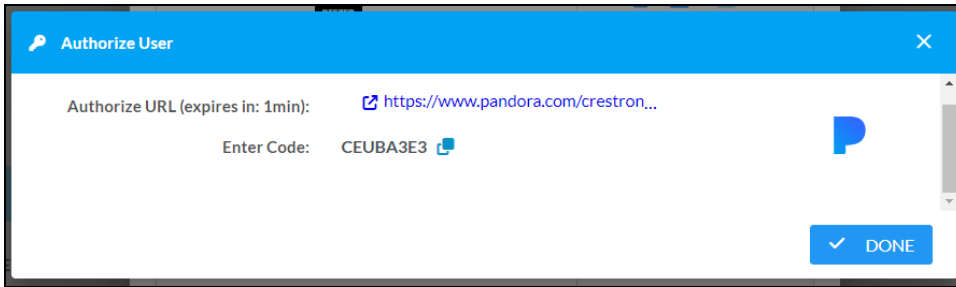

2. Select the link to register the device. The **Device Activation** page is displayed.

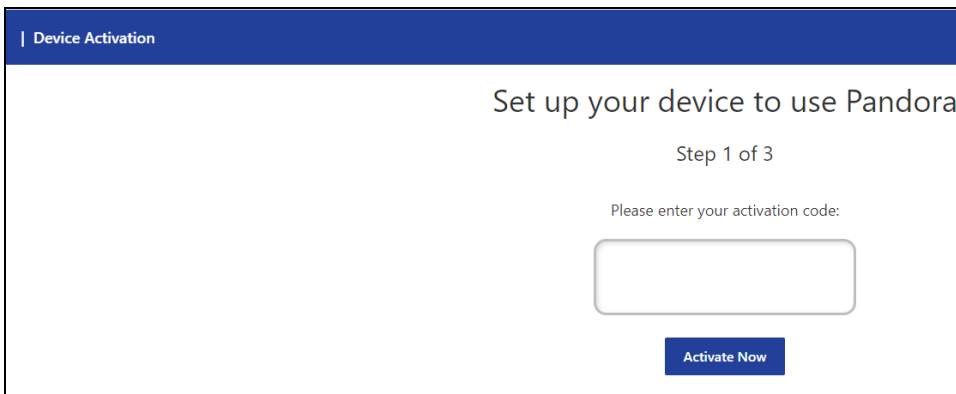

NOTE: The link is valid for one minute. After one minute, the link expires, and the **Authorize URL** and **Enter Code** are shown as blank. The **Authorize User** dialogue will need to be closed and reopened.

3. Paste the activation code in the **Please enter your activation code** field and select **Activate Now**.
4. Log in to the Pandora account.
5. Select **DONE** to return to **Streaming Services**.

Port Selection

The **Port Selection** feature allows the device's internal network traffic to be managed and segregated based on traffic type. Internal VLANs are used to segment device management and streaming service traffic to a separate physical device Ethernet port than audio-over-IP streaming traffic. With **Port Selection** enabled on all DM NAX devices on a network, DM NAX and AES67 network traffic can be physically separated from the control network onto a dedicated audio network.

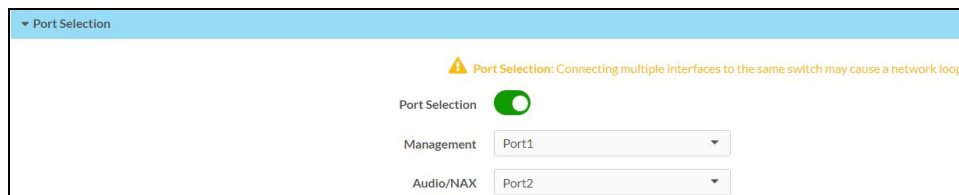

To configure **Port Selection**:

1. Set the **Port Selection** toggle to the right position to enable Port Selection. Set the toggle to the left position to disable Port Selection. By default, **Port Selection** is disabled.

NOTE: Ports 1 and 2 correspond to the Ethernet adapters labeled **1** and **2** on the rear panel of the DM-NAX-4ZSP, respectively.

2. With **Port Selection** enabled:

- a. Select an Ethernet port from the **Management** drop-down menu to designate which Ethernet port on the rear panel of the device will handle network traffic relating to device configuration, streaming services, and the device's connection to a control system.

NOTES:

- To access streaming services, the Management port must be connected to a network with internet access.
- The Management port determines your connection to the web interface. Changing the port value can result in losing your connection to the device via the web interface.

- b. Select an Ethernet port from the **Audio/NAX** drop-down menu to designate which Ethernet port on the rear panel of the device will handle audio-over-IP streaming network traffic.
3. Select **Save** changes to apply the new settings.

NOTE: Making changes to **Port Selection** settings will require a reboot.

Security

Select the **Security** tab to configure security for users and groups and to allow different levels of access to the DM-NAX-4ZSP functions. By default, security is disabled.

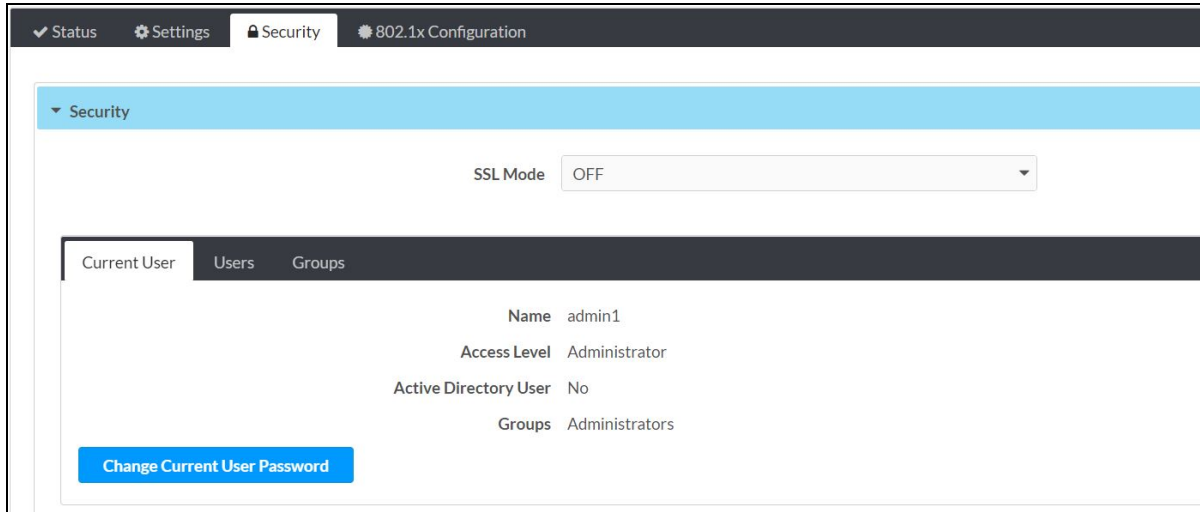

Select **Encrypt and Validate**, **Encrypt**, or **OFF** in the **SSL Mode** drop-down menu, to specify whether to use encryption. By default, SSL Mode is set to **OFF**.

Current User

Select the **Current User** tab to view read-only information or to change the password for the current user.

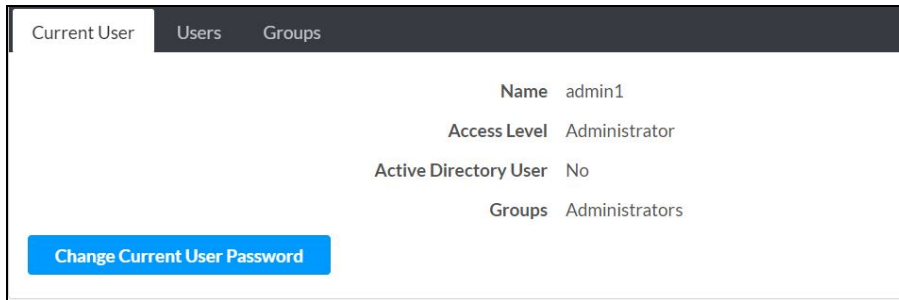

1. Select **Change Current User Password** to provide a new password for the current user.
2. In the **Change Password** dialog, enter the current password in the **Current Password** field, the new password in the **Password** field, and then re-enter the same new password in the **Confirm Password** field.

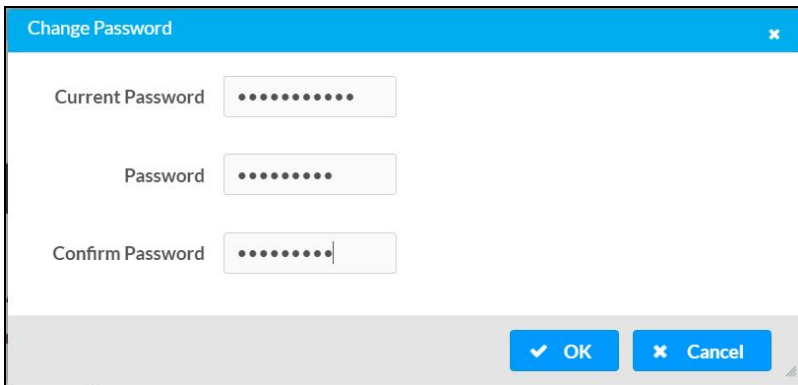

A dialog box titled "Change Password" with a close button (X) in the top right corner. It contains three input fields: "Current Password" with 10 dots, "Password" with 8 dots, and "Confirm Password" with 8 dots and a cursor. At the bottom, there are two buttons: "OK" with a checkmark icon and "Cancel" with an X icon.

3. Select **OK** to save or select **Cancel** to cancel the changes.

Users

Select the **Users** tab to view and edit user settings. The **Users** tab can be used to add or remove local and Active Directory users and preview information about users.

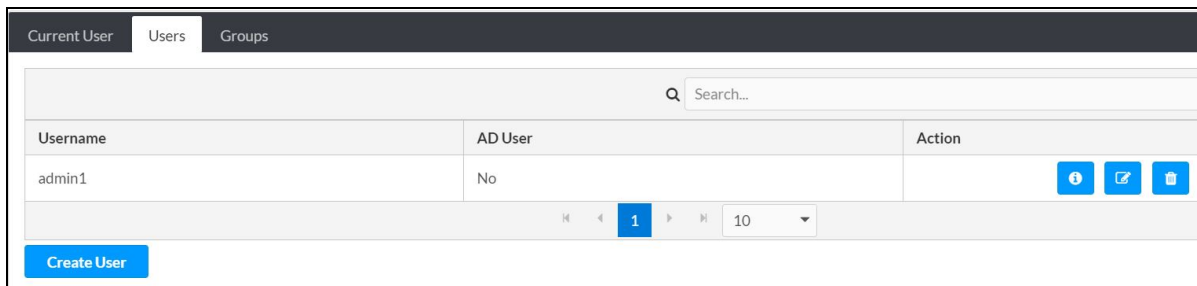

The "Users" tab interface shows a navigation bar with "Current User", "Users", and "Groups". Below is a search bar labeled "Search...". A table lists users with columns for "Username", "AD User", and "Action". The first row shows "admin1" with "No" in the AD User column and three icons (info, edit, delete) in the Action column. At the bottom, there are navigation arrows, a page number "1", and a dropdown menu set to "10". A "Create User" button is located at the bottom left.

Username	AD User	Action
admin1	No	[Info] [Edit] [Delete]

Use the **Search Users** field to enter search term(s) and display users that match the search criteria.

If users listed in the **Users** table span across multiple pages, navigate through the list of users by selecting a page number or by using the left or right arrows at the bottom of the **Users** pane to move forward or backward through the pages.

Each page can be set to display 5, 10, or 20 users by using the drop-down menu to the right of the navigation arrows.

Information about existing users is displayed in table format and the following details are provided for each user.

- **Username:** Displays the name of the user.
- **AD User:** Displays whether the user requires authentication using Active Directory.
Select the corresponding icon in the Actions column to view detailed user information or to delete the user.

To create a new user, select **Create User**.

Create a New Local User

1. Select **Create User** in the **Users** tab.
2. In the **Create User** dialog, enter the following:

- a. Enter a user name in the **Name** field. A valid user name can consist of alphanumeric characters (letters a-z, A-Z, numbers 0-9) and the underscore "_" character.
- b. Enter a password in the **Password** field; re-enter the same password in the **Confirm Password** field.
- c. Assign the access level by selecting one or more groups from the **Groups** drop-down list.

NOTE: Make sure that the **Active Directory User** toggle is disabled.

3. Select **OK** to save or select **Cancel** to cancel the changes.

Add an Active Directory User

Users cannot be created or removed from the Active Directory server, but access can be granted to an existing user in the Active Directory server.

To grant access to an Active Directory user, you can either add the user to a local group on the DM-NAX-4ZSP, or add the Active Directory group(s) that they are a member of to the DM-NAX-4ZSP.

To add an Active Directory user.

1. Select **Create User**.
2. In the **Create User** dialog, enter the following.

- a. Enter a user name in the **Name** field in the format "Domain\UserName", for example "crestronlabs.com\JohnSmith". Valid user names can contain alphanumeric characters (letters a-z, A-Z, numbers 0-9) and the underscore "_" character.
- b. Select one or more groups from the **Groups** drop-down list.

NOTE: Make sure that the **Active Directory User** toggle is set to enabled.

3. Select **OK** to save or select **Cancel** to cancel the changes.

Delete User

Select the trashcan icon  in the **Actions** column to delete the user. Select **Yes** when prompted to delete the user or **No** to cancel the deletion.

After a user is removed from a group, they lose any access rights associated with that group. Note that the user account is not deleted by the delete user operation.

View User Details

Select the information icon  in the **Actions** column to view information for the selected user. The **User Details** dialog displays the following information for the selected user.

- **Name:** Displays the name of the selected user.
- **Active Directory User:** Displays whether the user is an Active Directory user.
- **Group:** Displays group(s) the selected user is part of.

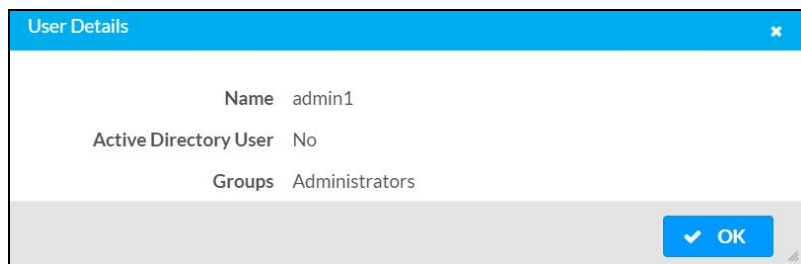

Select **OK** to close the **User Details** dialog and to return to the **Users** tab.

Update User Details

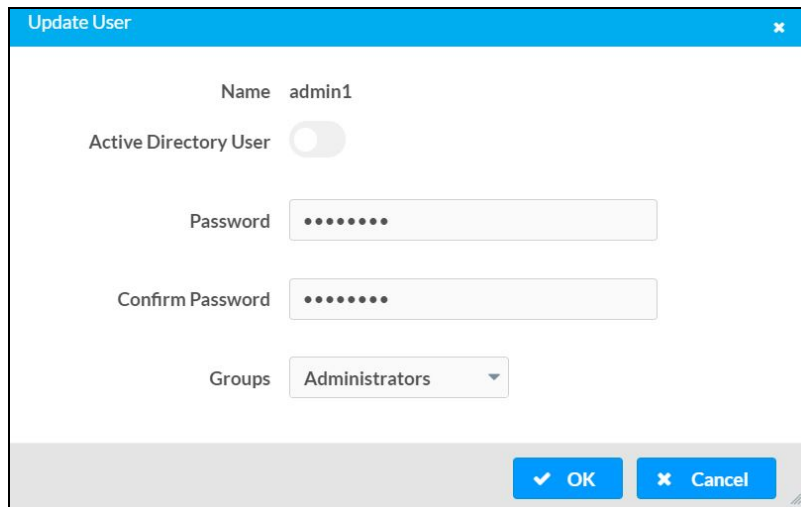

1. Select the edit icon  in the **Actions** column to update information for the selected user.
2. Enter a password in the **Password** field; re-enter the same password in the **Confirm Password** field.
3. Select one or more groups to assign the user to from the **Groups** drop-down list.
4. Select **OK** to save or select **Cancel** to cancel the changes.

The **Update User** dialog also displays the following read-only information for the selected user.









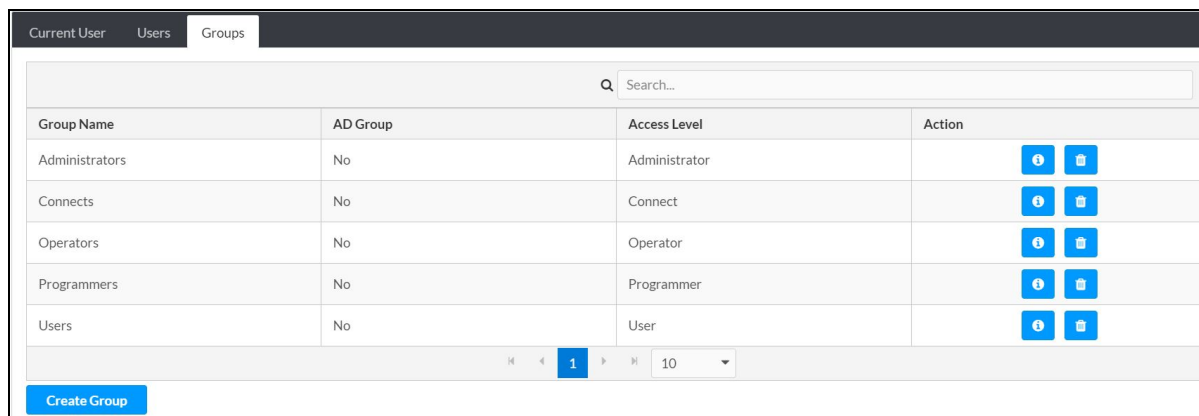

- **Name:** Displays the name of the user.
- **Active Directory User:** Displays whether the user is an Active Directory user.

Groups

Select the **Groups** tab to view and edit group settings. The **Groups** tab can be used to add local and Active Directory groups, remove local and Active Directory groups, and preview information about a group.

Use the **Search Groups** field to enter search term(s) and display groups that match the search criteria.





Group Name	AD Group	Access Level	Action
Administrators	No	Administrator	 
Connects	No	Connect	 
Operators	No	Operator	 
Programmers	No	Programmer	 
Users	No	User	 

If groups listed in the **Groups** table span across multiple pages, navigate through the groups by selecting a page number or by using the left or right arrows at the bottom of the **Groups** pane to move forward or backward through the pages.

Additionally, each page can be set to display 5, 10, or 20 groups by using the drop-down menu to the right of the navigation arrows.

Existing groups are displayed in a table and the following information is provided for each group:

- **Group Name:** Displays the name of the group.
- **AD Group:** Displays whether the group requires authentication using Active Directory.
- **Access Level:** Displays the predefined access level assigned to the group (Administrator, Programmer, Operator, User, or Connect).

Select the corresponding icon in the **Actions** column to view detailed group information  or to delete  selected group.

Select **Create Group** in the **Groups** tab to create new group.

Create Local Group

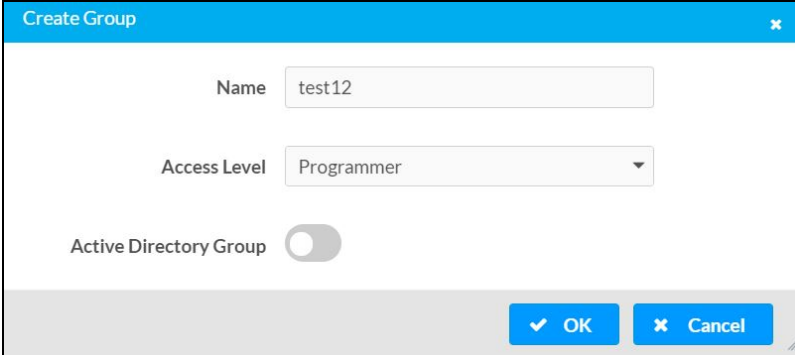

1. Select **Create Group**.
2. In the **Create Group** dialog, enter the following:
 - a. Enter the group name in the **Name** field.
 - b. Assign the group access level by selecting a predefined access level (Administrator, Connect, Operator, Programmer, User) from the **Access Level** drop-down list.

NOTE: Make sure that the **Active Directory Group** toggle is disabled.

3. Select **OK** to save. Select **Cancel** to cancel the changes.

Add Active Directory Group

A group cannot be created or removed from the Active Directory server, but access can be granted to an existing group in Active Directory.

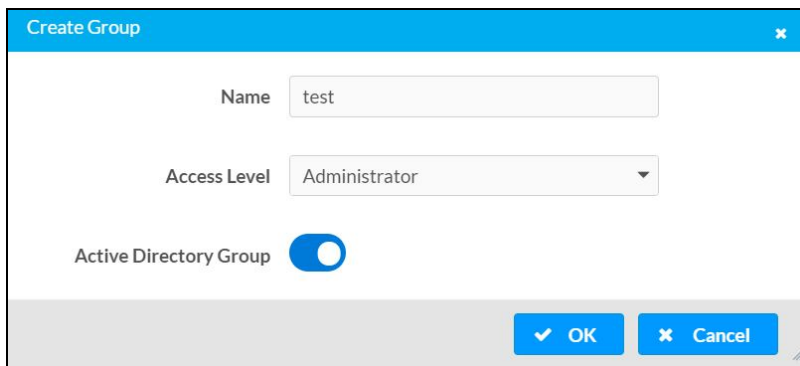

Once the group is added, all members of that group will have access to the DM-NAX-4ZSP.

1. Select **Create Group**.
2. In the **Create Group** dialog enter the following:
 - a. Enter the group name in the **Name** field, for example "Engineering Group". Note that group names are case sensitive; a space is a valid character that can be used in group names.
3. Assign the group access level by selecting a predefined access level (Administrator, Connect, Operator, Programmer, User) from the **Access Level** drop-down list.

NOTE: Make sure that the **Active Directory Group** toggle is enabled.

4. Select **OK** to save. Select **Cancel** to cancel the changes.

Delete a Group

Select the trashcan icon  in the **Actions** column to delete a group. Select **Yes** when prompted to delete the group or **No** to cancel the deletion.

When a group is deleted, users in the group are not removed from the device or Active Directory server. However, because a user's access level is inherited from a group(s), users within the deleted group will lose access rights associated with the group.

View Group Details

Select the information icon  in the **Actions** column to view information for the selected group. The **Group Details** dialog lists the following information for the selected group.

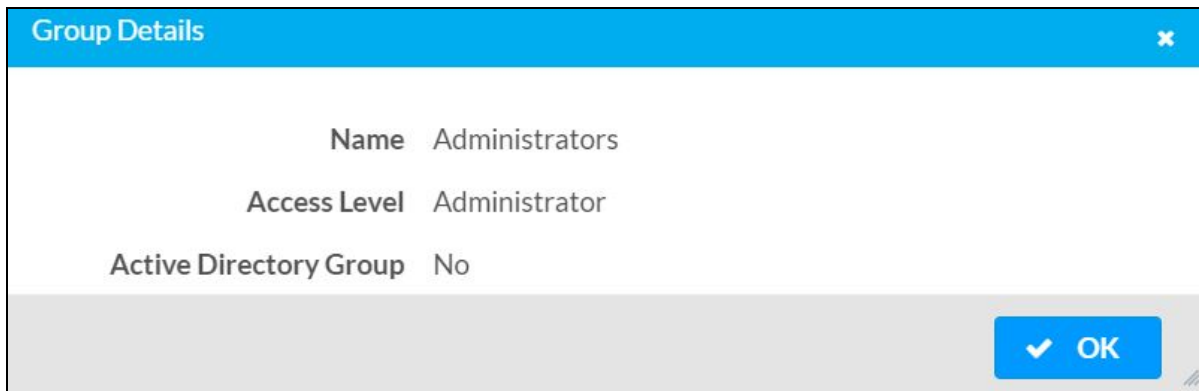

- **Name:** Displays the name of the group.
- **Access Level:** Displays the access level of the group and its users.
- **Active Directory Group:** Displays whether the group is an Active Directory group.

Select **OK** to close the **Group Details** dialog and to return to the **Groups** tab.

802.1x Configuration

The DM-NAX-4ZSP has built-in support for the 802.1X standard (an IEEE network standard designed to enhance the security of wireless and Ethernet LANs. The standard relies on the exchange of messages between the device and the network's host, or authentication server), allowing communication with the authentication server and access to protected corporate networks.

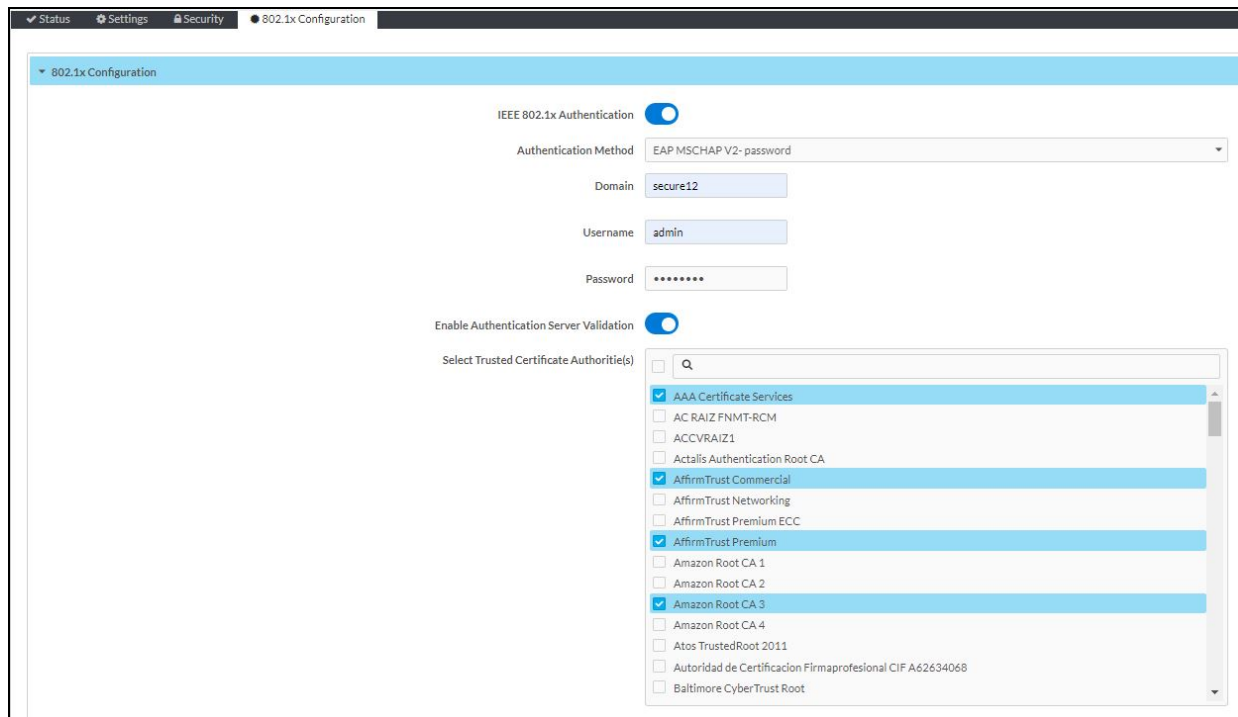

Configure DM-NAX-4ZSP for 802.1X Authentication

1. Set the **IEEE 802.1X Authentication** toggle to enabled. This will enable all options on the 802.1X dialog.
2. Select the **Authentication method: EAP-TLS Certificate** or **EAP-MSCHAP V2 Password** according to the network administrator's requirement.
3. Do either one of the following:
 - Select **EAP-TLS Certificate**: Select **Action/Manage Certificates** to upload the required machine certificate. The machine certificate is an encrypted file that will be supplied by the network administrator, along with the certificate password.
 - Select **EAP-MSCHAP V2 Password**: Enter the username and password supplied by the network administrator into the **Username** and **Password** fields. This method does not require the use of a machine certificate, only the user name and password credentials.

4. If you enabled the **Enable Authentication Server Validation** option, this will enable the **Select Trusted Certificate Authority(ies)** list box which contains signed Trusted Certificate Authorities (CAs) preloaded into the DM-NAX-4ZSP.

Select the check box next to each CA whose certificate can be used for server validation, as specified by the network administrator.

If the network does not use any of the listed certificates, the network administrator must provide a certificate, which must be uploaded manually via the **Manage Certificates** functionality.

5. If required, type the domain name of the network in the **Domain** field.
6. When the 802.1X settings are configured as desired, select **Save Changes** to save the changes to the device and reboot it. Select **Revert** to cancel any changes.

DM-NAX-16AIN

This section describes how to configure DM-NAX-16AIN.

Web Interface Configuration

The DM-NAX-16AIN web interface allows you to view status information and configure network and device settings.

Access the Web Interface

To access the web interface, do either of the following:

- [Access the Web Interface with a Web Browser on page 358](#)
- [Access the Web Interface With the Crestron Toolbox™ Application on page 360](#)

The web interface is accessed from a web browser. The following table lists operating systems and their corresponding supported web browsers.

Operating System and Supported Web Browsers

OPERATING SYSTEM	SUPPORTED WEB BROWSERS
Windows® operating system	Chrome™ web browser, version 31 and later Firefox® web browser, version 31 and later Internet Explorer web browser, version 11 and later Microsoft Edge web browser
macOS® operating system	Safari® web browser, version 6 and later Chrome web browser, version 31 and later Firefox web browser, version 31 and later

Access the Web Interface with a Web Browser

1. Enter the IP address of the DM-NAX-16AIN into a web browser.

NOTE: To obtain the IP address, use the **Device Discovery Tool** option in Crestron Toolbox™ application or an IP scanner application.

2. If you are creating a user account for the first time, do the following; otherwise, skip to step 3.
 - a. Enter a username in the **Username** field.
 - b. Enter a password in the **Password** field.
 - c. Re-enter the same password in the **Confirm Password** field.

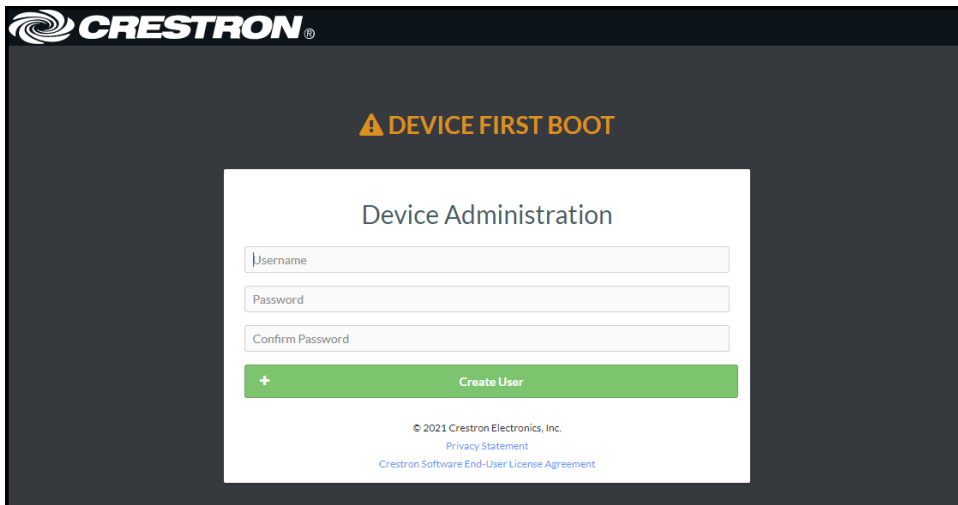

The screenshot shows the Crestron logo at the top left. Below it, a warning icon and the text "DEVICE FIRST BOOT" are displayed. The main content is a white box titled "Device Administration" containing three input fields: "Username", "Password", and "Confirm Password". Below these fields is a green button with a plus sign and the text "Create User". At the bottom of the white box, there is copyright information: "© 2021 Crestron Electronics, Inc.", a link for "Privacy Statement", and a link for "Crestron Software End-User License Agreement".

- d. Select **Create User**. The Device Administration page appears.

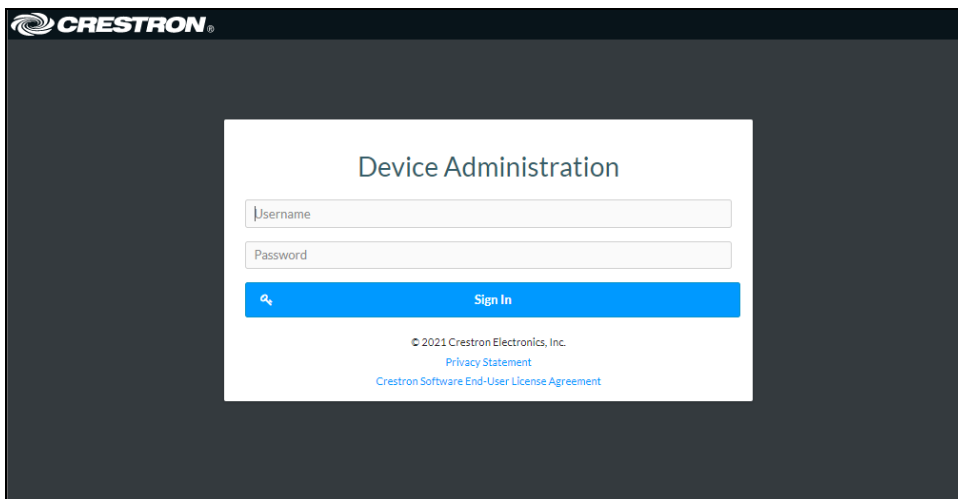

The screenshot shows the Crestron logo at the top left. Below it, the text "DEVICE FIRST BOOT" is no longer present. The main content is a white box titled "Device Administration" containing two input fields: "Username" and "Password". Below these fields is a blue button with a magnifying glass icon and the text "Sign In". At the bottom of the white box, there is copyright information: "© 2021 Crestron Electronics, Inc.", a link for "Privacy Statement", and a link for "Crestron Software End-User License Agreement".

3. Enter the username in the **Username** field.
4. Enter the password in the **Password** field.
5. Select **Sign In**.

Access the Web Interface With the Crestron Toolbox™ Application

To access the web interface by opening a web browser from the Crestron Toolbox™ application:

1. Open the Crestron Toolbox application.
2. From the **Tools** menu, select **Device Discovery Tool**. You can also access the Device Discovery Tool by selecting the Device Discovery Tool icon  in the Crestron Toolbox toolbar. The DM-NAX-16AIN is discovered and listed in the device list on the left side of the screen. The associated host name, IP address, and firmware version are also displayed.

NOTE: If there is security software running on the computer, a security alert might be displayed when the Crestron Toolbox application attempts to connect to the network. Make sure to allow the connection, so that the Device Discovery Tool can be used.

3. In the Device Discovery Tool list, select the device.
4. Enter the device credentials in the **Authentication Required** dialog that opens, then select **Log In**.
5. Select **Web Configuration**.

Action

The **Action** drop-down menu is displayed at the top right side of the interface and provides quick access to common device functions:

- [Save Changes on page 361](#)
- [Revert on page 361](#)
- [Reboot on page 362](#)
- [Restore to Factory Default Settings on page 362](#)
- [Update Firmware on page 362](#)
- [Download Logs on page 363](#)
- [Manage Certificates on page 363](#)

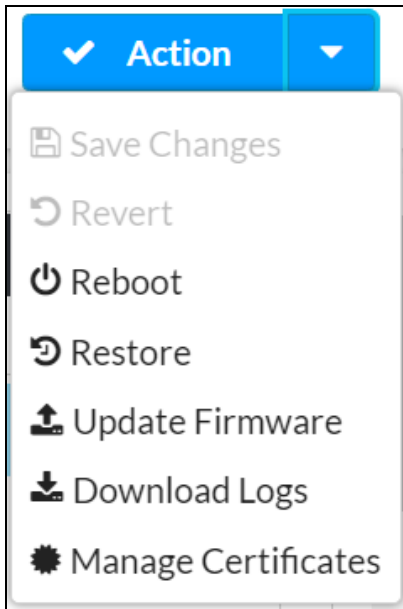

Save Changes

Select **Save Changes** to save any changes made to the configuration settings.

Revert

Select **Revert** to revert the device back to the last saved configuration settings.

Reboot

Certain changes to the settings may require the DM-NAX-16AIN to be rebooted to take effect. To reboot the device:

1. Select **Reboot** in the **Action** drop-down menu. The **Confirmation** message box appears.

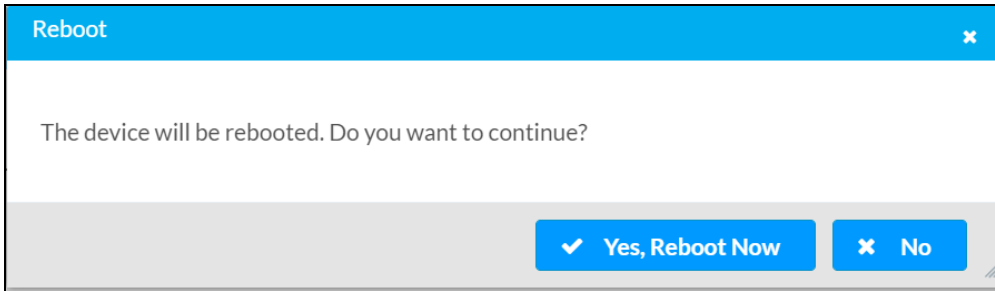

2. Select **Yes, Reboot Now** to reboot the device. The **Reboot** message box appears. Wait for the device reboot to complete before attempting to reconnect to the device.

Restore to Factory Default Settings

1. Select **Restore** in the **Action** drop-down menu to restore the settings of the DM-NAX-16AIN to factory defaults.

NOTE: When settings are restored, all settings, including the network settings, will revert to the factory default. If a static IP address is set, restoring the device to factory default settings will revert the IP address to the default DHCP mode.

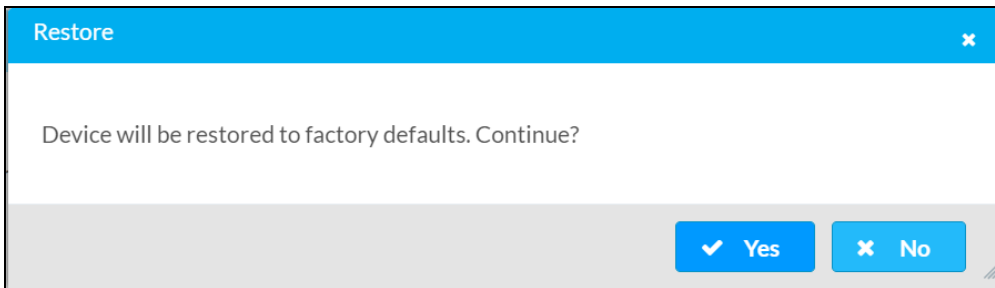

2. Select **Yes** in the **Confirmation** dialog to restore the DM-NAX-16AIN to factory settings. Select **No** to cancel the restore operation.

A dialog is displayed again, indicating that the restore process was successful and that the device rebooted.

You can also restore to factory settings by pressing and holding the **SETUP** button on the rear panel of the device with power disconnected then connect the power supply and continue to hold **SETUP** button for 30 seconds.

Update Firmware

1. Select **Update Firmware** in the **Action** drop-down menu.
2. In the **Firmware Upgrade** dialog, select **+ Browse**.

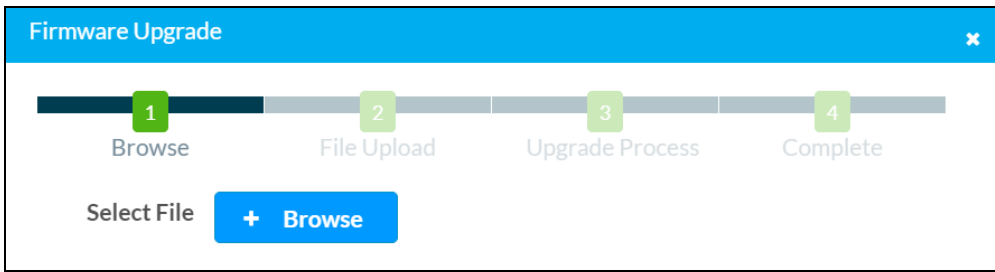

3. Locate and select the desired firmware file, and then select **Open**. The selected firmware file name is displayed in the **Firmware Upgrade** dialog.
4. Select **Load** and wait for the progress bar to complete and for **OK** to become selectable.
5. Select **OK**. The device with new firmware can now be accessed.

Download Logs

Select **Download Logs** in the **Action** drop-down menu to download the device message logs for diagnostic purposes.

The log file is downloaded to the Downloads folder of the PC.

Manage Certificates

Use the **Manage Certificates** dialog to add, remove, and manage certificates used in 802.1x and other protected networks.

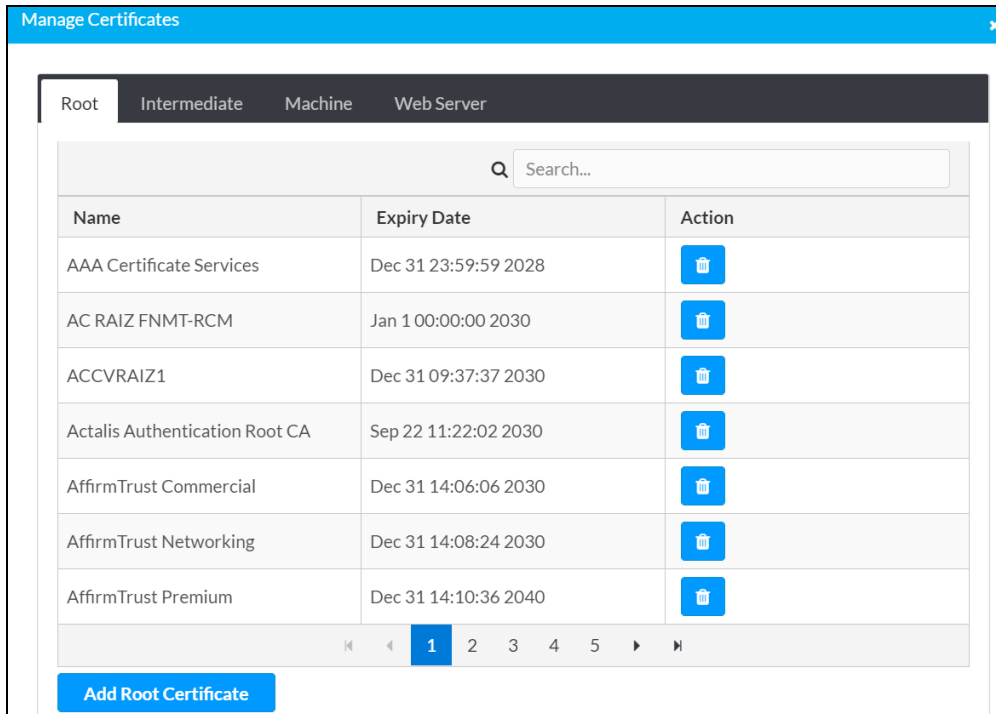

Select **Manage Certificates** in the **Action** drop-down menu. The following certificate tabs are displayed:

- **Root:** The Root certificate is used by the DM-NAX-16AIN to validate the network's authentication server. The DM-NAX-16AIN has a variety of Root certificates, self-signed by trusted CAs (Certificate Authorities) preloaded into the device. Root certificates must be self-signed.
- **Intermediate:** The Intermediate store holds non self-signed certificates that are used to validate the authentication server. These certificates will be provided by the network administrator if the network does not use self-signed Root certificates.
- **Machine:** The machine certificate is an encrypted PFX file that is used by the authentication server to validate the identity of the DM-NAX-16AIN. The machine certificate will be provided by the network administrator, along with the certificate password. For 802.1x, only one machine certificate can reside on the device.
- **Web Server:** The Web Server certificate is a digital file that contains information about the identity of the web server.

To Add Certificates

1. Select the corresponding certificate tab.
2. Select **Add Root Certificate**.
3. Select **+ Browse**.
4. Locate and select the file, and then select **Open**.

NOTE: If the certificate is a Machine Certificate, enter the password provided by the network administrator.

5. Select **OK**. This will add the certificate to the list box, displaying the file name and expiration date. The certificate is now available for selection and can be loaded to the device.

To Delete Certificates

1. Select the corresponding certificate tab.
2. Select the trashcan icon  in the **Actions** column to delete the certificate.
3. Select **Yes** when prompted to delete the certificate or **No** to cancel the deletion.

Status

The **Status** page is the first page displayed when opening the interface of the DM-NAX-16AIN. It displays general information about the DM-NAX-16AIN (such as Model Name, Firmware Version, and Serial Number) and current network settings (such as Host Name and IP Address, etc.).

The Status page can be accessed at any time by selecting the **Status** tab of the DM-NAX-16AIN interface.

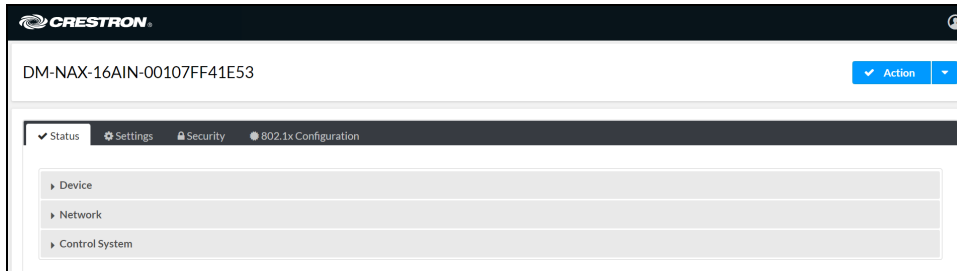

Information displayed on the **Status** tab is organized into different sections.

Device

The **Device** section displays the **Model**, **Firmware Version**, and **Serial Number** of the DM-NAX-16AIN.

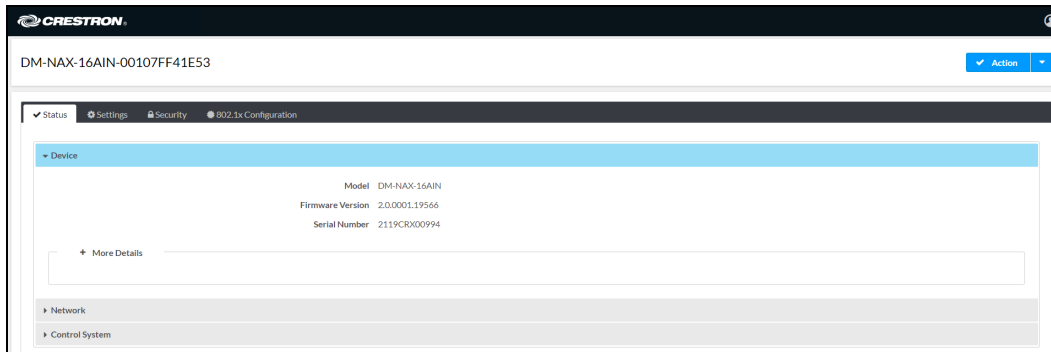

Select **+ More Details** to review additional information about the DM-NAX-16AIN.

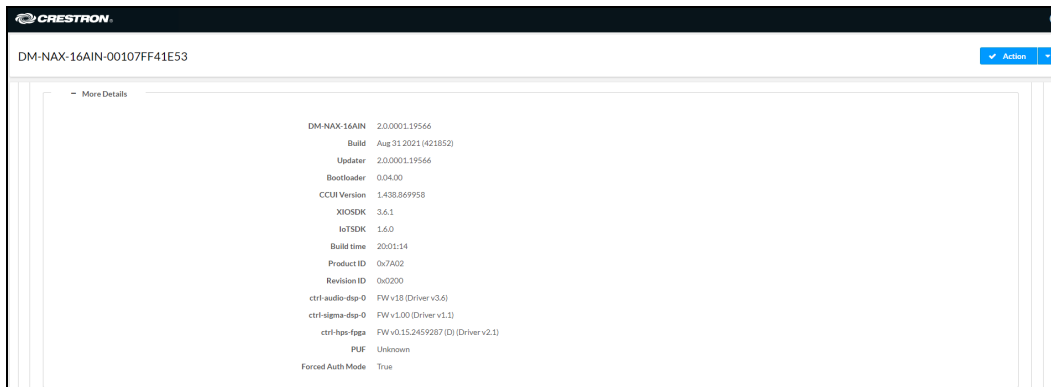

Network

The **Network** section displays network-related information about the DM-NAX-16AIN, including the Hostname, Domain Name, and DNS Servers.

Network

Hostname DM-NAX-16AIN-00107FF41E53

Domain Name

Primary Static DNS

Secondary Static DNS

- Adapter 1

DHCP Yes

IP Address 10.254.68.87

Subnet Mask 255.255.0.0

Default Gateway 10.254.68.1

Link Active true

MAC Address 00.10.7f.f4.1e.53

NOTE: By default, the host name of the DM-NAX-16AIN consists of the model name followed by the MAC address of the device. For example, DM-NAX-16AIN-00107FF41E53.

Select **+ Adapter 1** to display an expanded section that shows additional information. If **+ Adapter 1** is selected, select **- Adapter 1** to collapse the section.

NOTE: The **+ Adapter 2** option appears when the dual Ethernet ports on the DM-NAX-16AIN are set to isolate traffic using the **Port Selection** feature. Refer to [Settings on page 367](#) for details on configuring the **Port Selection** feature.

Control System

The **Control System** section displays connection information, consisting of the following:

Control System

Encrypt Connection OFF

- IP Table

IP ID	Room ID	IP Address/Hostname	Type	Server Port	Connection	Status
No records found						

- **Encrypt Connection:** ON or OFF
- **IP ID:** Reports the currently used IP ID of the DM-NAX-16AIN
- **IP Address/Hostname:** The IP address of the control system
- **Room ID:** Displays the room ID
- **Status:** OFFLINE or ONLINE

Settings

The **Settings** page enables you to configure the DM-NAX-16AIN settings. The **Settings** page can be accessed at any time by selecting the **Settings** tab of the DM-NAX-16AIN interface.



Settings available on the **Settings** page are organized into different sections.

System Setup

The **System Setup** section contains settings for **Date/Time**, **Auto Update**, **Network**, and **Control System**.

Date/Time

Use the **Date/Time** section to configure the date and time settings of the DM-NAX-16AIN.

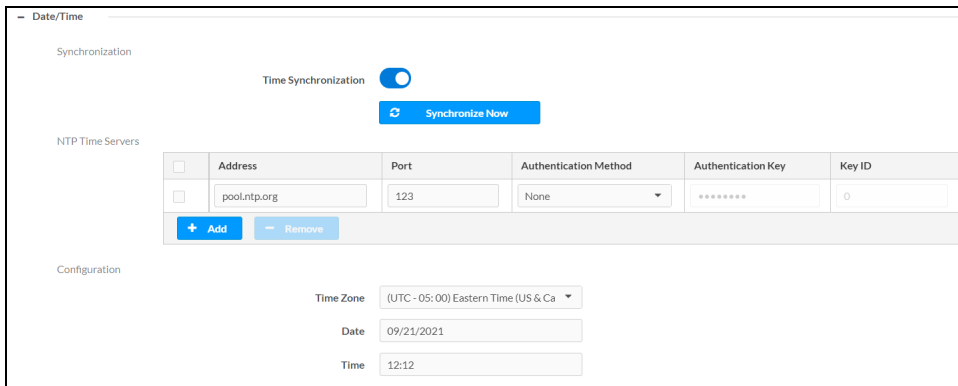

Time Synchronization

1. Set the **Time Synchronization** toggle to the right position to enable or left position to disable time synchronization. By default, time synchronization is enabled.
2. In the **NTP Time Servers** table, enter the URL of a NTP (Network Time Protocol) or SNTP (Simple Network Time Protocol) server. Up to three time servers can be added on a device.
3. Select **Synchronize Now** to perform time synchronization between the device's internal clock and the time server.

Time Configuration

1. Open the **Time Zone** drop-down menu to select the applicable time zone.
2. In the **Date** field, enter the current date.
3. In the **Time (24hr Format)** field, enter the current time in 24-hour format.

Select **Save Changes** to save the settings.

Select **Revert** from the **Action** drop-down menu to revert to the previous settings without saving.

Auto Update

The DM-NAX-16AIN can automatically check for and install firmware updates at scheduled intervals via the Auto Update feature.

Auto Update

Auto Update

Custom URL

Custom URL Path

Schedule

Day of Week

Time of Day

Poll Interval Minutes

[Update Now](#)

1. Set the **Auto Update** toggle to the right position to enable Auto Update.
2. Define the URL to download the updates by doing either of the following:
 - a. Use the default URL to download the updates from the Crestron server.
 - b. Use a custom URL. Set the **Custom URL** toggle to the right position to enable a custom URL. In the **Custom URL Path** text box, enter the path to a custom manifest file in the FTP or SFTP URL format. Use the Crestron Auto Update Tool to generate a custom manifest file, then store the file on an FTP (File Transfer Protocol) or SFTP (Secure File Transfer Protocol) server.
3. Set a schedule for the automatic firmware update by doing either of the following:
 - a. Select the desired **Day of Week** and **Time of Day** (24-hour format) values.
 - b. Set the **Poll Interval** by entering a value from **60** to **65535** minutes. A value of **0** disables the Poll Interval.
4. Select **Save Changes**.

Selecting **Update Now** causes the device to check for a firmware update immediately. If a schedule was set in step 4 above, that schedule still remains in effect.

Network

The **Network** section contains network-related settings for the DM-NAX-16AIN, including the Hostname, Domain, Primary Static DNS, and Secondary Static DNS.

The screenshot shows a network configuration interface for 'Adapter 1'. It includes the following fields and settings:

- Hostname: DM-NAX-16AIN-00107FF41E53
- Domain: (empty)
- Primary Static DNS: (empty)
- Secondary Static DNS: (empty)
- DHCP: Enabled (toggle switch is on)
- IP Address: 10.254.68.87
- Subnet Mask: 255.255.0.0
- Default Gateway: 10.254.68.1

NOTE: By default, the hostname of the DM-NAX-16AIN consists of the model name followed by the MAC address of the device. For example, DM-NAX-16AIN-00107FB58088.

Adapter 1

The Adapter 1 subheading contains settings for DHCP, IP Address, Subnet Mask, and Default Gateway of Ethernet adapter 1 on the rear panel of the device.

NOTES:

- An **+ Adapter 2** option only appears when the dual Ethernet ports on the DM-NAX-8ZSA are set to isolate traffic using the Port Selection feature. The settings for Adapter 2 are identical to those available for Adapter 1.
- DM NAX devices' internal processes use IP addresses in the 10.10.10.xxx range. This IP range should be avoided when addressing DM NAX devices to prevent conflicts.

Set the **DHCP** toggle to enabled (right) or disabled (left) to specify whether the IP address of the DM-NAX-16AIN is to be assigned by a DHCP (Dynamic Host Configuration Protocol) server.

- **Enabled:** When DHCP is enabled (default setting), the IP address of the DM-NAX-16AIN is automatically assigned by a DHCP server on the local area network (LAN).
- **Disabled:** When DHCP is disabled, manually enter information in the following fields:
 - **Primary Static DNS:** Enter a primary DNS IP address.
 - **Secondary Static DNS:** Enter a secondary DNS IP address.
 - **IP Address:** Enter a unique IP address for the DM-NAX-16AIN.
 - **Subnet Mask:** Enter the subnet mask that is set on the network.
 - **Default Gateway:** Enter the IP address that is to be used as the network's gateway.

To save any new network entries, select **Save Changes**.

Control System

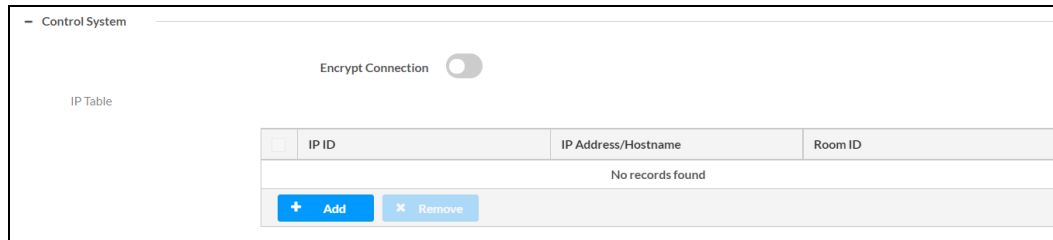

1. Set the **Encrypt Connection** toggle to the right to enable a secure connection between the control system and the DM-NAX-16AIN. Set the toggle to the left to use an unencrypted connection to the control system. If the toggle is set to the right:
 - a. Enter the username in the **Control System Username** field.
 - b. Enter the password in the **Control System Password** field.
2. Select **+ Add** to add an IP table entry to the **IP Table**.
 - a. Enter the Room ID in the **Room ID** field.
 - b. Enter the IP ID of the DM-NAX-16AIN in the **IP ID** field.
 - c. Enter the IP address or hostname of the control system in the **IP Address/Hostname** field.
3. Select **Save Changes** to save the new entries. The **Control System Save** message box appears, indicating that the control system settings were saved successfully. Select **Revert** to revert to the previous settings without saving.

Commissioning

The **Commissioning** section provides a quick way to automatically assign multicast addresses to all of the device's internal audio-over-IP stream transmitters.

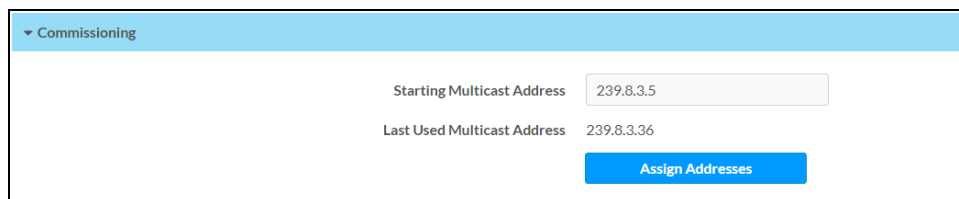

Select **Assign Addresses** to give each DM NAX transmitter in the DM-NAX-16AIN a unique multicast address beginning with the specified **Starting Multicast Address**. The valid range for **Starting Multicast Address** is 239.8.0.0 to 239.255.255.239.

NOTE: This will begin transmitting multicast traffic on your network. Refer to [Audio-over-IP Network Design on page 632](#) for details on proper audio-over-IP network management.

Inputs

The **Inputs** menu is used to configure **Name**, **Compensation**, and **Mute** attributes of the available analog and digital inputs on the DM-NAX-16AIN.

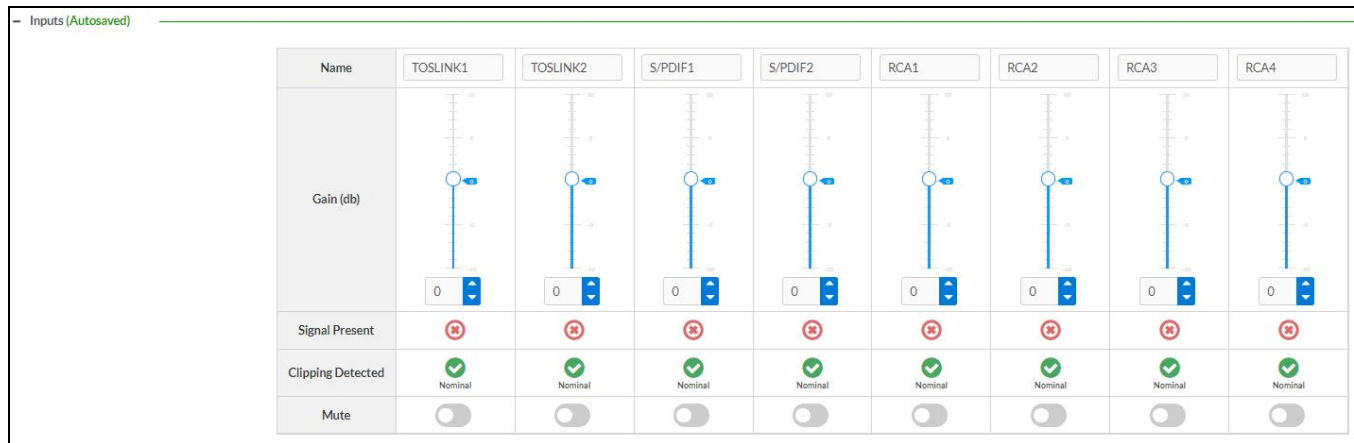

The screenshot shows the 'Inputs (Autosaved)' configuration menu. It features a table with 8 columns representing different input types: TOSLINK1, TOSLINK2, S/PDIF1, S/PDIF2, RCA1, RCA2, RCA3, and RCA4. Each column has a 'Name' field at the top, a 'Gain (db)' section with a vertical slider and a numeric input field (all set to 0), a 'Signal Present' indicator (a red 'X' in a circle), a 'Clipping Detected' indicator (a green checkmark in a circle with the word 'Nominal' below it), and a 'Mute' toggle switch (all are currently turned off).

Name	TOSLINK1	TOSLINK2	S/PDIF1	S/PDIF2	RCA1	RCA2	RCA3	RCA4
Gain (db)								
Signal Present								
Clipping Detected	 Nominal	 Nominal	 Nominal	 Nominal	 Nominal	 Nominal	 Nominal	 Nominal
Mute	<input type="checkbox"/>	<input type="checkbox"/>	<input type="checkbox"/>	<input type="checkbox"/>	<input type="checkbox"/>	<input type="checkbox"/>	<input type="checkbox"/>	<input type="checkbox"/>

Configure Inputs

1. If needed, enter a friendly name for each input in its **Name** field.
2. To set a level compensation adjustment for a given input, do one of the following:
 - Move the **Compensation** slider up to increase or down to decrease the compensation. Compensation increases the level of the incoming audio signal on any of the physical inputs on the device's rear panel.
 - Use the **db** arrows to increase or decrease the compensation. Values range from -10 dB to 10 dB, adjustable in increments of 1 dB.
 - Manually enter a value in the **Compensation** field.
3. To mute the signal from the corresponding input, select **Mute**. To disable the mute, select **Muted**. By default, **Mute** is disabled.

Monitor the device's input signals using the text indicators in the **Signal Present** and **Clipping Detected** columns:

- **Signal Presence** indicates whether or not a signal is detected in that zone.
- **Clipping Detected** indicates if the signal is **Clipping** or **Nominal** (non-clipping).

Use the **Global Filter** text field to filter specific inputs by name. Not all of the available inputs are shown on the first page in this section when no **Global Filter** is applied. Use  at the bottom of the table to view the next page of inputs.

DM NAX Streams

Each local input of the DM-NAX-8ZSA can be made available as a DM NAX audio-over-IP stream.

Select **NAX Streams** to display the following information.

+ NAX Streams					
Device is Master PTP Clock Source No					
Master Clock Status 00107ffffe.f4062b					
PTP Priority <input type="text" value="254"/>					
- Transmitters (Autosaved)					
Input Name	Stream	Nax Stream Address	Nax Stream Name	Status	Actions
Analog1	Stream01	<input type="text" value="0.0.0"/>	<input type="text" value="Analog1100.10.7ff4.1e.53"/>	Stream Stopped	
Analog2	Stream02	<input type="text" value="0.0.0"/>	<input type="text" value="Analog2200.10.7ff4.1e.53"/>	Stream Stopped	
Analog3	Stream03	<input type="text" value="0.0.0"/>	<input type="text" value="Analog3300.10.7ff4.1e.53"/>	Stream Stopped	
Analog4	Stream04	<input type="text" value="0.0.0"/>	<input type="text" value="Analog4400.10.7ff4.1e.53"/>	Stream Stopped	
Analog5	Stream05	<input type="text" value="0.0.0"/>	<input type="text" value="Analog5500.10.7ff4.1e.53"/>	Stream Stopped	
Analog6	Stream06	<input type="text" value="0.0.0"/>	<input type="text" value="Analog6600.10.7ff4.1e.53"/>	Stream Stopped	
Analog7	Stream07	<input type="text" value="0.0.0"/>	<input type="text" value="Analog7700.10.7ff4.1e.53"/>	Stream Stopped	
Analog8	Stream08	<input type="text" value="0.0.0"/>	<input type="text" value="Analog8800.10.7ff4.1e.53"/>	Stream Stopped	
S/PDIF1	Stream09	<input type="text" value="0.0.0"/>	<input type="text" value="S/PDIF1900.10.7ff4.1e.53"/>	Stream Stopped	

- **Device is Leader PTP Clock Source** indicates whether the device is the leader for PTP on the network. **Yes** will be displayed in green when the local DM-NAX-16AIN is the PTP leader clock and **No** will be displayed in red when another PTP clock on the network is operating as the leader clock.
- **Leader Clock Status** displays the Leader Clock ID of the device on the network that acts as the Leader Clock.
- **PTP Priority:** This sets the priority of the local DM NAX device's PTP clock relative to other clocks on the network. The default setting is 254 (one increment higher than the lowest possible value) so that the DM-NAX-16AIN will only operate as the leader clock if no other PTP leader is present on the network. Valid values range from 1 to 255.

Configure Transmitters

- Transmitters (Autosaved)					
Input Name	Stream	Nax Stream Address	Nax Stream Name	Status	Actions
Analog1	Stream01	<input type="text" value="0.0.0"/>	<input type="text" value="Analog1100.10.7ff4.1e.53"/>	Stream Stopped	
Analog2	Stream02	<input type="text" value="0.0.0"/>	<input type="text" value="Analog2200.10.7ff4.1e.53"/>	Stream Stopped	
Analog3	Stream03	<input type="text" value="0.0.0"/>	<input type="text" value="Analog3300.10.7ff4.1e.53"/>	Stream Stopped	
Analog4	Stream04	<input type="text" value="0.0.0"/>	<input type="text" value="Analog4400.10.7ff4.1e.53"/>	Stream Stopped	
Analog5	Stream05	<input type="text" value="0.0.0"/>	<input type="text" value="Analog5500.10.7ff4.1e.53"/>	Stream Stopped	
Analog6	Stream06	<input type="text" value="0.0.0"/>	<input type="text" value="Analog6600.10.7ff4.1e.53"/>	Stream Stopped	
Analog7	Stream07	<input type="text" value="0.0.0"/>	<input type="text" value="Analog7700.10.7ff4.1e.53"/>	Stream Stopped	
Analog8	Stream08	<input type="text" value="0.0.0"/>	<input type="text" value="Analog8800.10.7ff4.1e.53"/>	Stream Stopped	
S/PDIF1	Stream09	<input type="text" value="0.0.0"/>	<input type="text" value="S/PDIF1900.10.7ff4.1e.53"/>	Stream Stopped	
S/PDIF2	Stream10	<input type="text" value="0.0.0"/>	<input type="text" value="S/PDIF21000.10.7ff4.1e.53"/>	Stream Stopped	

1 of 2

NOTE: To configure transmitters not shown on the current page of the table, select the icon to display the next page of eight transmitters.

To configure a DM NAX transmit stream:

1. Enter a valid multicast address in the **NAX Stream Address** field.
2. Enter a name in the **NAX Stream Name** field by which the stream can be identified. This stream name is associated with the DM NAX stream's multicast address by other DM NAX or AES67 devices, like a device hostname that resolves to a given IP address.
3. **Status** indicates whether a stream is transmitting or not. When the stream has started or stopped, the **Status** column will update accordingly.
4. Select the configure icon  in the **Actions** column. The **Configure** dialog appears:

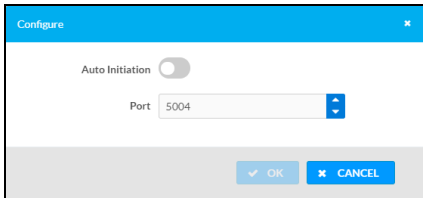

5. Set the **Auto Initiation** toggle to the right position to enable auto initiation. Set the toggle to the left position to disable auto initiation.
 - If **Auto Initiation** is enabled for a given stream, the stream will begin transmitting automatically and will be available as a multicast stream on your network at the specified multicast address.
 - If **Auto Initiation** is disabled for the input, the stream will not begin transmitting until it is manually initiated.
6. To set the port number, do one of the following:
 - Use the arrows to increase or decrease the port number by increments of 1.
 - Manually enter a port number in the **Port** field. The default port number for DM NAX streams is 5004.
7. Select **OK** to save or select **Cancel** to cancel the changes.

Port Selection

The **Port Selection** feature allows the device's internal network traffic to be managed and segregated based on traffic type. Internal VLANs are used to segment device management and streaming service traffic to a separate physical device Ethernet port than audio-over-IP streaming traffic. With **Port Selection** enabled on all DM NAX devices on a network, DM NAX and AES67 network traffic can be physically separated from the control network onto a dedicated audio network.

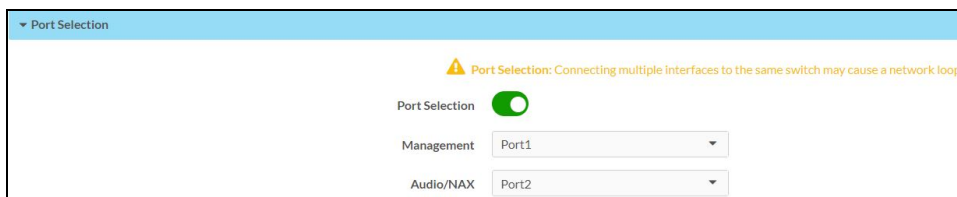

To configure **Port Selection**:

1. Set the **Port Selection** toggle to the right position to enable Port Selection. Set the toggle to the left position to disable Port Selection. By default, **Port Selection** is disabled.

NOTE: Ports 1 and 2 correspond to the Ethernet adapters labeled **1** and **2** on the rear panel of the DM-NAX-16AIN, respectively.

2. With **Port Selection** enabled:
 - a. Select an Ethernet port from the **Management** drop-down menu to designate which Ethernet port on the rear panel of the device will handle network traffic relating to device configuration and the device's connection to a control system.

NOTE: The Management port controls your connection to the web interface. Changing the port value can result in losing your connection to the device via the web interface.
 - b. Select an Ethernet port from the **Audio/NAX** drop-down menu to designate which Ethernet port on the rear panel of the device will handle audio-over-IP streaming network traffic.
3. Select **Save** changes to apply the new settings.

NOTE: Making changes to **Port Selection** settings will require a reboot.

Security

Select the **Security** tab to configure security for users and groups and to allow different levels of access to the DM-NAX-16AIN functions . By default, security is disabled.

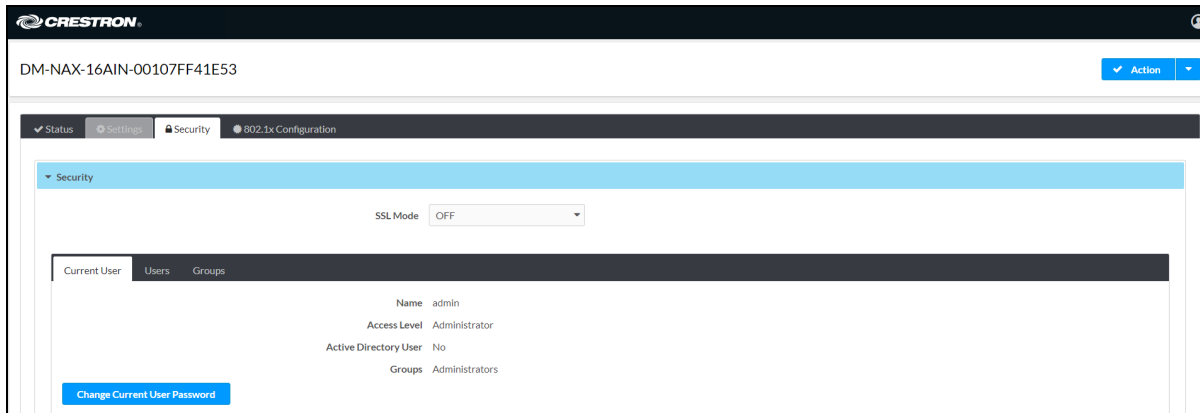

Select **Encrypt and Validate**, **Encrypt**, or **OFF** in the **SSL Mode** drop-down menu, to specify whether to use encryption. By default, SSL Mode is set to **OFF**.

Current User

Select the **Current User** tab to view read-only information or to change the password for the current user.

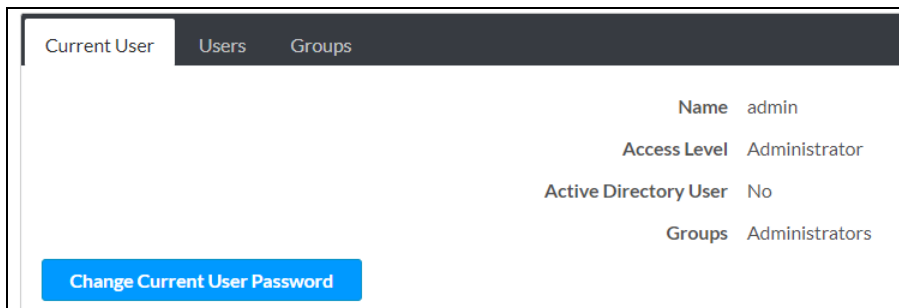

1. Select **Change Current User Password** to provide a new password for the current user.
2. In the **Change Password** dialog, enter the current password in the **Current Password** field, the new password in the **Password** field, and then re-enter the same new password in the **Confirm Password** field.

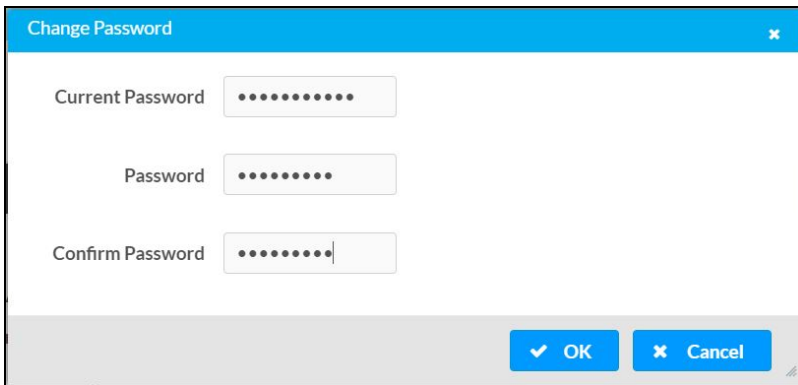

A dialog box titled "Change Password" with a close button (X) in the top right corner. It contains three input fields: "Current Password" with 10 dots, "Password" with 8 dots, and "Confirm Password" with 8 dots and a cursor. At the bottom, there are two buttons: "OK" with a checkmark icon and "Cancel" with an X icon.

3. Select **OK** to save or select **Cancel** to cancel the changes.

Users

Select the **Users** tab to view and edit user settings. The **Users** tab can be used to add or remove local and Active Directory users and preview information about users.

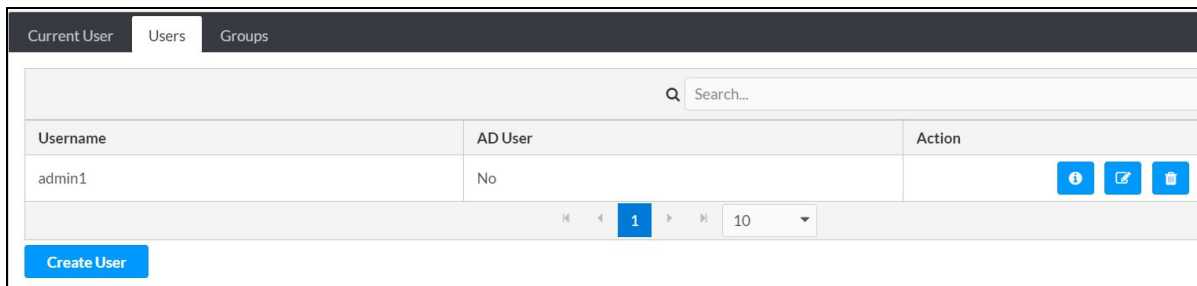

The "Users" tab interface shows a navigation bar with "Current User", "Users", and "Groups". Below is a search bar labeled "Search...". A table lists users with columns for "Username", "AD User", and "Action". The first row shows "admin1" with "No" in the AD User column and three icons (info, edit, delete) in the Action column. At the bottom, there are navigation arrows, a page number "1", and a dropdown menu set to "10". A "Create User" button is located at the bottom left.

Username	AD User	Action
admin1	No	[Info] [Edit] [Delete]

Use the **Search Users** field to enter search term(s) and display users that match the search criteria.

If users listed in the **Users** table span across multiple pages, navigate through the list of users by selecting a page number or by using the left or right arrows at the bottom of the **Users** pane to move forward or backward through the pages.

Each page can be set to display 5, 10, or 20 users by using the drop-down menu to the right of the navigation arrows.

Information about existing users is displayed in table format and the following details are provided for each user.

- **Username:** Displays the name of the user.
- **AD User:** Displays whether the user requires authentication using Active Directory.
Select the corresponding icon in the Actions column to view detailed user information or to delete the user.

To create a new user, select **Create User**.

Create a New Local User

1. Select **Create User** in the **Users** tab.
2. In the **Create User** dialog, enter the following:

The screenshot shows a 'Create User' dialog box with the following fields and controls:

- Name:** A text input field containing the text 'test'.
- Active Directory User:** A toggle switch that is disabled (greyed out).
- Password:** A text input field with masked characters (dots).
- Confirm Password:** A text input field with masked characters (dots).
- Groups:** A dropdown menu with 'Administrators' selected.
- Buttons:** 'OK' and 'Cancel' buttons at the bottom right.

- a. Enter a user name in the **Name** field. A valid user name can consist of alphanumeric characters (letters a-z, A-Z, numbers 0-9) and the underscore "_" character.
- b. Enter a password in the **Password** field; re-enter the same password in the **Confirm Password** field.
- c. Assign the access level by selecting one or more groups from the **Groups** drop-down list.

NOTE: Make sure that the **Active Directory User** toggle is disabled.

3. Select **OK** to save or select **Cancel** to cancel the changes.

Add an Active Directory User

Users cannot be created or removed from the Active Directory server, but access can be granted to an existing user in the Active Directory server.

To grant access to an Active Directory user, you can either add the user to a local group on the DM-NAX-16AIN, or add the Active Directory group(s) that they are a member of to the DM-NAX-16AIN.

To add an Active Directory user.

1. Select **Create User**.
2. In the **Create User** dialog, enter the following.

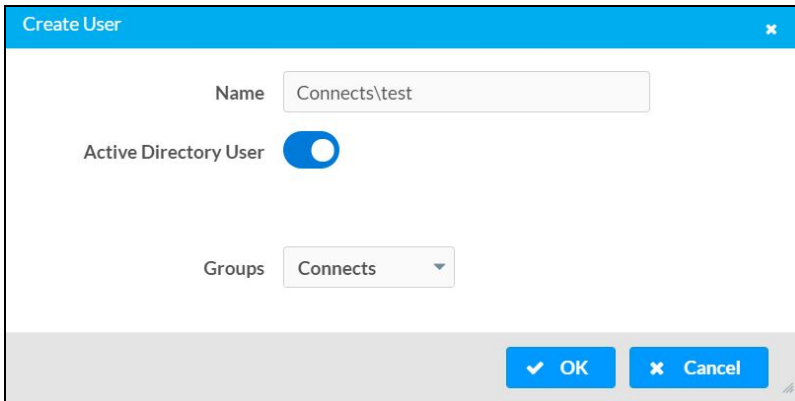

The screenshot shows a 'Create User' dialog box with a blue header. It contains three main input areas: a 'Name' text box with 'Connects\test', an 'Active Directory User' toggle switch that is turned on, and a 'Groups' dropdown menu with 'Connects' selected. At the bottom right, there are two buttons: 'OK' with a checkmark icon and 'Cancel' with an 'x' icon.

- a. Enter a user name in the **Name** field in the format "Domain\UserName", for example "crestronlabs.com\JohnSmith". Valid user names can contain alphanumeric characters (letters a-z, A-Z, numbers 0-9) and the underscore "_" character.
- b. Select one or more groups from the **Groups** drop-down list.

NOTE: Make sure that the **Active Directory User** toggle is set to enabled.

3. Select **OK** to save or select **Cancel** to cancel the changes.

Delete User

Select the trashcan icon  in the **Actions** column to delete the user. Select **Yes** when prompted to delete the user or **No** to cancel the deletion.

After a user is removed from a group, they lose any access rights associated with that group. Note that the user account is not deleted by the delete user operation.

View User Details

Select the information icon  in the **Actions** column to view information for the selected user. The **User Details** dialog displays the following information for the selected user.

- **Name:** Displays the name of the selected user.
- **Active Directory User:** Displays whether the user is an Active Directory user.
- **Group:** Displays group(s) the selected user is part of.

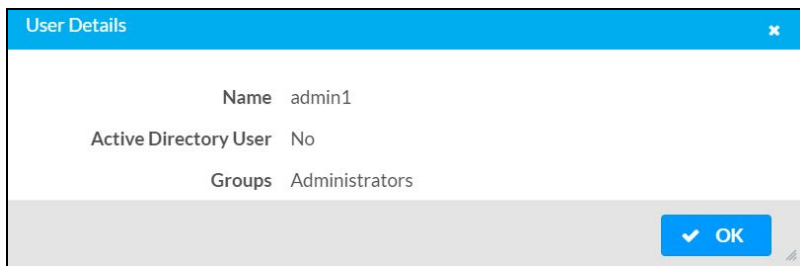

Select **OK** to close the **User Details** dialog and to return to the **Users** tab.

Update User Details

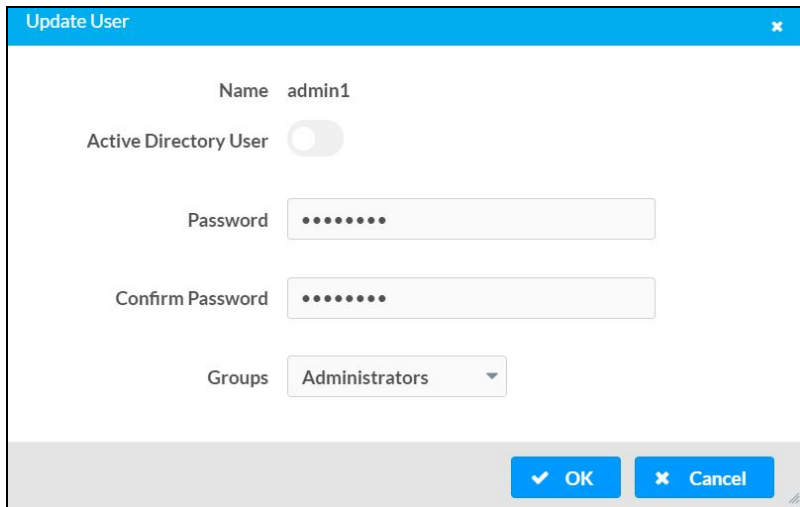

1. Select the edit icon  in the **Actions** column to update information for the selected user.
2. Enter a password in the **Password** field; re-enter the same password in the **Confirm Password** field.
3. Select one or more groups to assign the user to from the **Groups** drop-down list.
4. Select **OK** to save or select **Cancel** to cancel the changes.

The **Update User** dialog also displays the following read-only information for the selected user.

- **Name:** Displays the name of the user.
- **Active Directory User:** Displays whether the user is an Active Directory user.







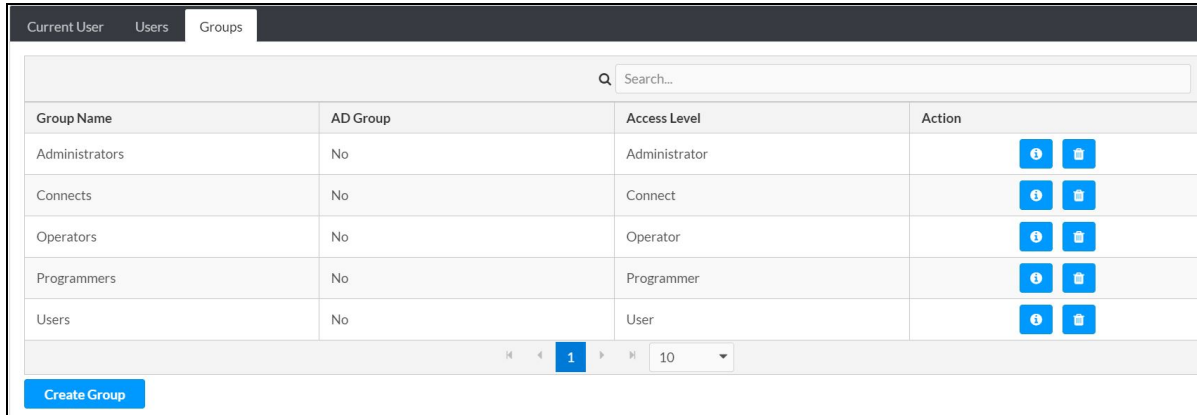



Groups

Select the **Groups** tab to view and edit group settings. The **Groups** tab can be used to add local and Active Directory groups, remove local and Active Directory groups, and preview information about a group.

Use the **Search Groups** field to enter search term(s) and display groups that match the search criteria.



The screenshot shows the 'Groups' tab interface. At the top, there are tabs for 'Current User', 'Users', and 'Groups'. Below the tabs is a search bar labeled 'Search...'. The main area contains a table with the following columns: 'Group Name', 'AD Group', 'Access Level', and 'Action'. The table lists five groups: Administrators, Connects, Operators, Programmers, and Users. Each group has a corresponding 'Action' column with two icons: an information icon (i) and a delete icon (trash). Below the table, there are navigation arrows and a page number '1' in a blue box, followed by a drop-down menu showing '10'. At the bottom left, there is a 'Create Group' button.



Group Name	AD Group	Access Level	Action
Administrators	No	Administrator	 
Connects	No	Connect	 
Operators	No	Operator	 
Programmers	No	Programmer	 
Users	No	User	 

If groups listed in the **Groups** table span across multiple pages, navigate through the groups by selecting a page number or by using the left or right arrows at the bottom of the **Groups** pane to move forward or backward through the pages.

Additionally, each page can be set to display 5, 10, or 20 groups by using the drop-down menu to the right of the navigation arrows.

Existing groups are displayed in a table and the following information is provided for each group:

- **Group Name:** Displays the name of the group.
- **AD Group:** Displays whether the group requires authentication using Active Directory.
- **Access Level:** Displays the predefined access level assigned to the group (Administrator, Programmer, Operator, User, or Connect).

Select the corresponding icon in the **Actions** column to view detailed group information  or to delete  the selected group.

Select **Create Group** in the **Groups** tab to create a new group.

Create Local Group

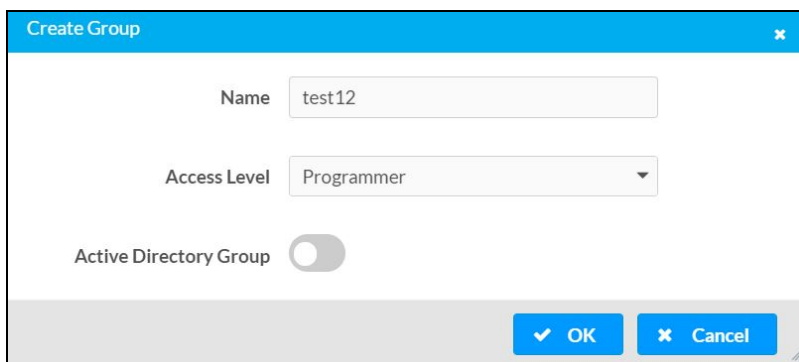

The screenshot shows the 'Create Group' dialog box. It has a title bar with 'Create Group' and a close button (x). The dialog contains three fields: 'Name' with the value 'test12', 'Access Level' with a dropdown menu showing 'Programmer', and 'Active Directory Group' with a toggle switch that is currently turned off. At the bottom, there are two buttons: 'OK' and 'Cancel'.

1. Select **Create Group**.
2. In the **Create Group** dialog, enter the following:
 - a. Enter the group name in the **Name** field.
 - b. Assign the group access level by selecting a predefined access level (Administrator, Connect, Operator, Programmer, User) from the **Access Level** drop-down list.

NOTE: Make sure that the **Active Directory Group** toggle is disabled.

3. Select **OK** to save. Select **Cancel** to cancel the changes.

Add Active Directory Group

A group cannot be created or removed from the Active Directory server, but access can be granted to an existing group in Active Directory.

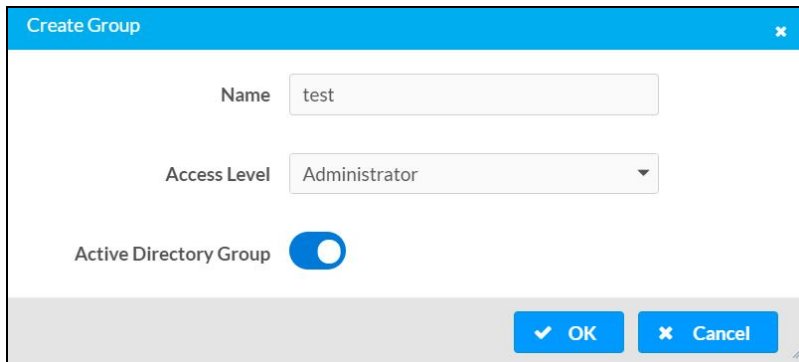

The screenshot shows a 'Create Group' dialog box with a blue header. It contains three main fields: 'Name' with the text 'test', 'Access Level' with a dropdown menu showing 'Administrator', and 'Active Directory Group' with a toggle switch that is currently turned on. At the bottom right, there are two buttons: 'OK' with a checkmark icon and 'Cancel' with an 'X' icon.

Once the group is added, all members of that group will have access to the DM-NAX-16AIN.

1. Select **Create Group**.
2. In the **Create Group** dialog enter the following:
 - a. Enter the group name in the **Name** field, for example "Engineering Group". Note that group names are case sensitive; a space is a valid character that can be used in group names.
3. Assign the group access level by selecting a predefined access level (Administrator, Connect, Operator, Programmer, User) from the **Access Level** drop-down list.

NOTE: Make sure that the **Active Directory Group** toggle is enabled.

4. Select **OK** to save. Select **Cancel** to cancel the changes.

Delete a Group

Select the trashcan icon  in the **Actions** column to delete a group. Select **Yes** when prompted to delete the group or **No** to cancel the deletion.

When a group is deleted, users in the group are not removed from the device or Active Directory server. However, because a user's access level is inherited from a group(s), users within the deleted group will lose access rights associated with the group.

View Group Details

Select the information icon  in the **Actions** column to view information for the selected group. The **Group Details** dialog lists the following information for the selected group.

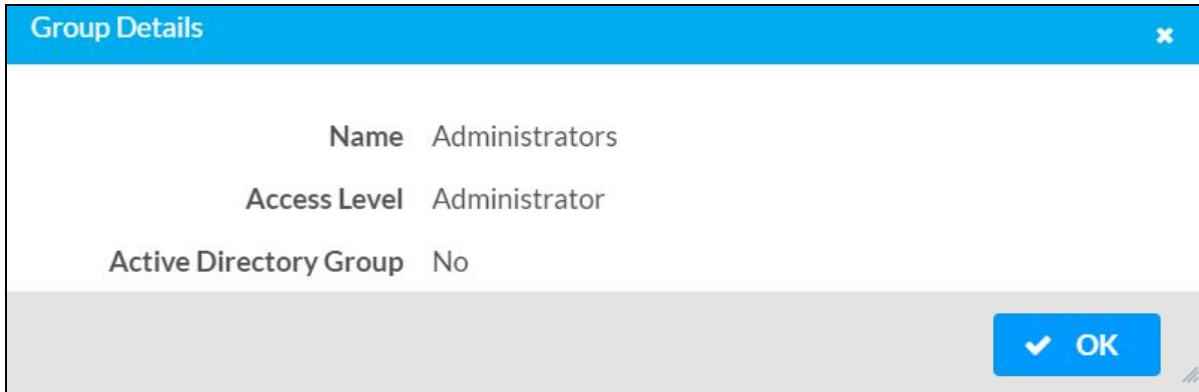

- **Name:** Displays the name of the group.
- **Access Level:** Displays the access level of the group and its users.
- **Active Directory Group:** Displays whether the group is an Active Directory group.

Select **OK** to close the **Group Details** dialog and to return to the Groups tab.

802.1x Configuration

The DM-NAX-16AIN has built-in support for the 802.1X standard (an IEEE network standard designed to enhance the security of wireless and Ethernet LANs. The standard relies on the exchange of messages between the device and the network's host, or authentication server), allowing communication with the authentication server and access to protected corporate networks.

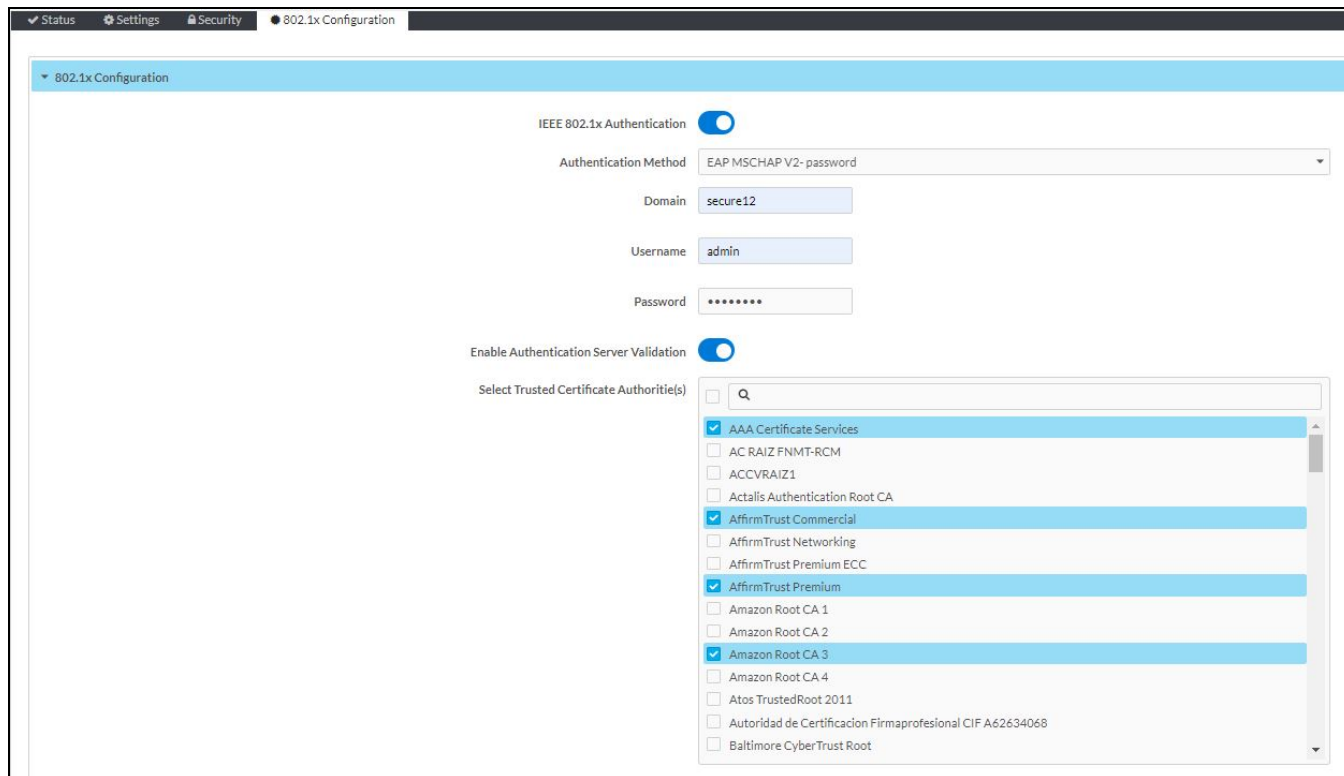

Configure DM-NAX-16AIN for 802.1X Authentication

1. Set the **IEEE 802.1X Authentication** toggle to enabled. This will enable all options on the 802.1X dialog.
2. Select the **Authentication method: EAP-TLS Certificate** or **EAP-MSCHAP V2 Password** according to the network administrator's requirement.
3. Do either one of the following:
 - Select **EAP-TLS Certificate**: Select **Action/Manage Certificates** to upload the required machine certificate. The machine certificate is an encrypted file that will be supplied by the network administrator, along with the certificate password.
 - Select **EAP-MSCHAP V2 Password**: Enter the username and password supplied by the network administrator into the **Username** and **Password** fields. This method does not require the use of a machine certificate, only the user name and password credentials.

4. If you enabled the **Enable Authentication Server Validation** option, this will enable the **Select Trusted Certificate Authority(ies)** list box which contains signed Trusted Certificate Authorities (CAs) preloaded into the DM-NAX-16AIN.

Select the check box next to each CA whose certificate can be used for server validation, as specified by the network administrator.

If the network does not use any of the listed certificates, the network administrator must provide a certificate, which must be uploaded manually via the **Manage Certificates** functionality.

5. If required, type the domain name of the network in the **Domain** field.
6. When the 802.1X settings are configured as desired, select **Save Changes** to save the changes to the device and reboot it. Select **Revert** to cancel any changes.

DM-NAX-AMP-X300

This section describes how to configure the DM-NAX-AMP-X300.

Web Interface Configuration

The DM-NAX-AMP-X300 web interface allows you to view status information and configure network and device settings.

NOTE: Throughout the web interface, values can be entered manually. When values entered manually fall out of the range, the value will be maximized or minimized or have no effect.

Access the Web Interface

To access the web interface, do either of the following:

- [Access the Web Interface with a Web Browser on page 386](#)
- [Access the Web Interface With the Crestron Toolbox™ Application \(DM-NAX-AMP-X300\) on page 387](#)

The web interface is accessed from a web browser. The following table lists operating systems and their corresponding supported web browsers.

Operating System and Supported Web Browsers

OPERATING SYSTEM	SUPPORTED WEB BROWSERS
Windows® operating system	Chrome™ web browser, version 31 and later Firefox® web browser, version 31 and later Internet Explorer web browser, version 11 and later Microsoft Edge web browser
macOS® operating system	Safari® web browser, version 6 and later Chrome web browser, version 31 and later Firefox web browser, version 31 and later

Access the Web Interface with a Web Browser

1. Enter the IP address of the DM-NAX-AMP-X300 into a web browser.

NOTE: To obtain the IP address, use the **Device Discovery Tool** option in Crestron Toolbox™ application or an IP scanner application.

2. If you are creating a user account for the first time, do the following; otherwise, skip to step 3.
 - a. Enter a username in the **Username** field.
 - b. Enter a password in the **Password** field.
 - c. Re-enter the same password in the **Confirm Password** field.

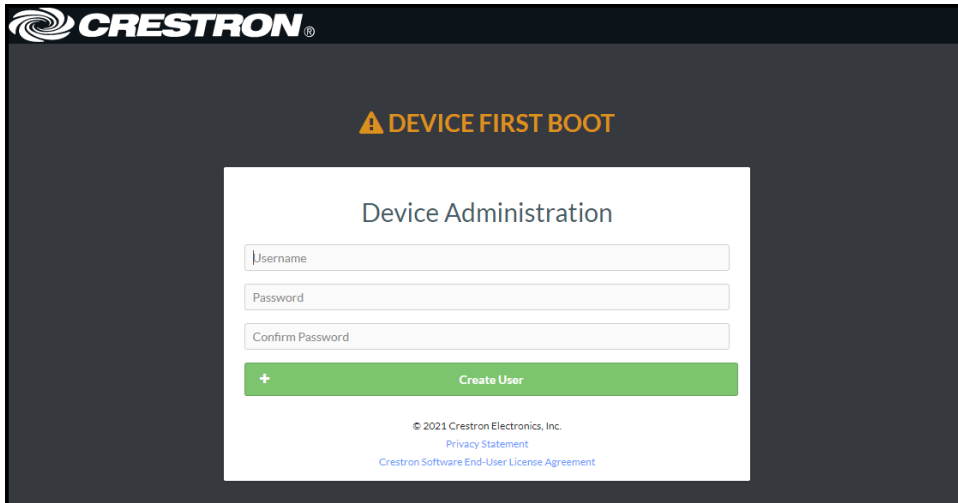

The screenshot shows the Crestron logo at the top left. Below it, a warning icon and the text "DEVICE FIRST BOOT" are displayed. The main content is a white box titled "Device Administration" containing three input fields: "Username", "Password", and "Confirm Password". Below these fields is a green button with a plus sign and the text "Create User". At the bottom of the white box, there is copyright information: "© 2021 Crestron Electronics, Inc.", "Privacy Statement", and "Crestron Software End-User License Agreement".

- d. Select **Create User**. The Device Administration page appears.

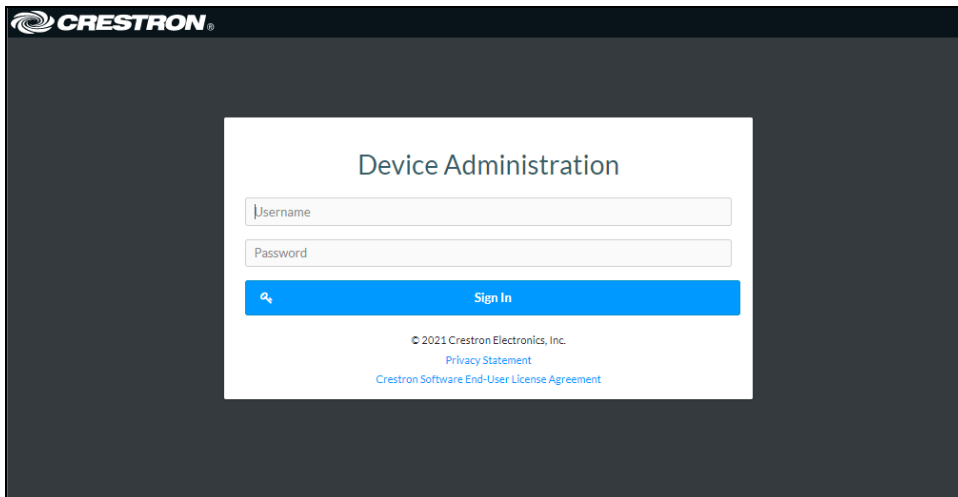

The screenshot shows the Crestron logo at the top left. Below it, the text "DEVICE FIRST BOOT" is no longer present. The main content is a white box titled "Device Administration" containing two input fields: "Username" and "Password". Below these fields is a blue button with a magnifying glass icon and the text "Sign In". At the bottom of the white box, there is copyright information: "© 2021 Crestron Electronics, Inc.", "Privacy Statement", and "Crestron Software End-User License Agreement".

3. Enter the username in the **Username** field.
4. Enter the password in the **Password** field.
5. Select **Sign In**.

Access the Web Interface With the Crestron Toolbox™ Application (DM-NAX-AMP-X300)

To access the web interface by opening a web browser within the Crestron Toolbox™ application:

1. Open the Crestron Toolbox application.
2. From the **Tools** menu, select **Device Discovery Tool**. You can also access the Device Discovery Tool by selecting the Device Discovery Tool icon  in the Crestron Toolbox toolbar. The DM-NAX-AMP-X300 is discovered and listed in the device list on the left side of the screen. The associated host name, IP address, and firmware version are also displayed.

NOTE: If there is security software running on the computer, a security alert might be displayed when the Crestron Toolbox application attempts to connect to the network. Make sure to allow the connection, so that the Device Discovery Tool can be used.

3. In the Device Discovery Tool list, select the device.
4. Enter the device credentials in the **Authentication Required** dialog that opens, then select **Log In**.
5. Select **Web Configuration**.

Action

The **Action** drop-down menu is displayed at the top right side of the interface and provides quick access to common device functions:

- [Save Changes on page 388](#)
- [Revert on page 388](#)
- [Reboot on page 389](#)
- [Restore to Factory Default Settings on page 389](#)
- [Update Firmware on page 389](#)
- [Download Logs on page 390](#)
- [Manage Certificates on page 390](#)

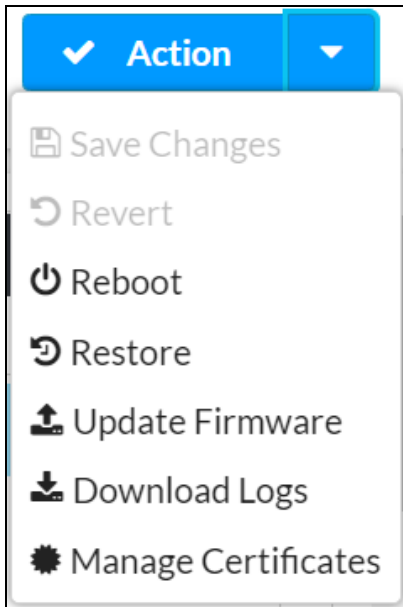

Save Changes

Select **Save Changes** to save any changes made to the configuration settings.

Revert

Select **Revert** to revert the device back to the last saved configuration settings.

Reboot

Certain changes to the settings may require the DM-NAX-AMP-X300 to be rebooted to take effect. To reboot the device:

1. Select **Reboot** in the **Action** drop-down menu. The **Confirmation** message box appears.

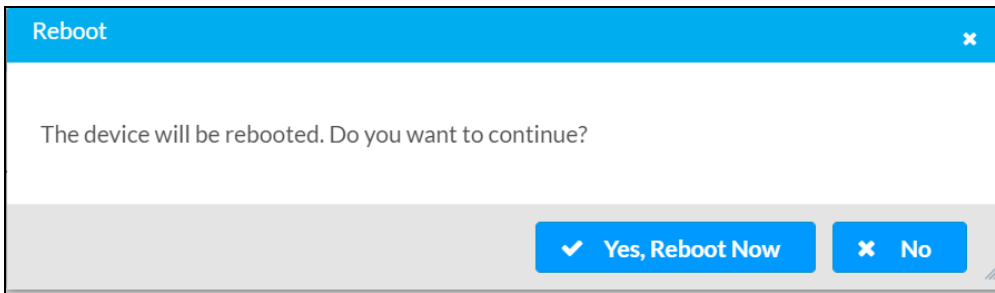

2. Select **Yes, Reboot Now** to reboot the device. The **Reboot** message box appears. Wait for the device reboot to complete before attempting to reconnect to the device.

Restore to Factory Default Settings

1. Select **Restore** in the **Action** drop-down menu to restore the settings of the DM-NAX-AMP-X300 to factory defaults.

NOTE: When settings are restored, all settings, including the network settings, will revert to the factory default. If a static IP address is set, restoring the device to factory default settings will revert the IP address to the default DHCP mode.

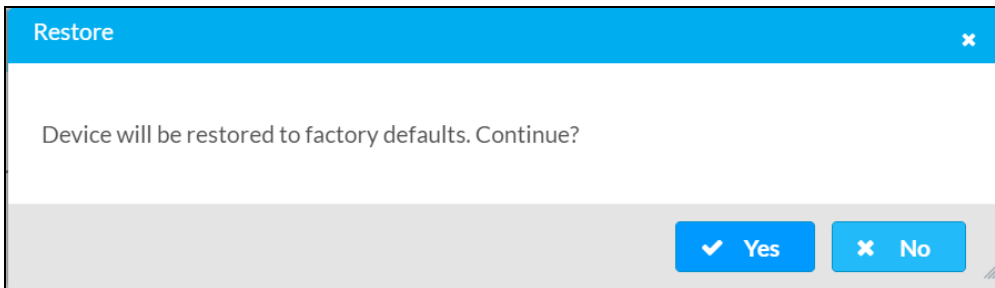

2. Select **Yes** in the **Confirmation** dialog to restore the DM-NAX-AMP-X300 to factory settings. Select **No** to cancel the restore operation.

A dialog is displayed again, indicating that the restore process was successful and that the device rebooted.

You can also restore the device by following the **Reset** procedures covered in [DM-NAX-AMP-X300 Installation on page 101](#).

Update Firmware

1. Select **Update Firmware** in the **Action** drop-down menu.
2. In the **Firmware Upgrade** dialog, select **+ Browse**.

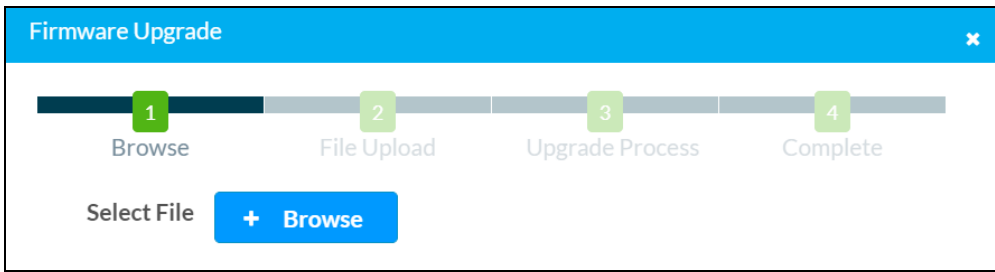

3. Locate and select the desired firmware file, and then select **Open**. The selected firmware file name is displayed in the **Firmware Upgrade** dialog.
4. Select **Load** and wait for the progress bar to complete and for **OK** to become selectable.
5. Select **OK**. The device with new firmware can now be accessed.

Download Logs

Select **Download Logs** in the **Action** drop-down menu to download the device message logs for diagnostic purposes.

The log file is downloaded to the Downloads folder of the PC.

Manage Certificates

Use the **Manage Certificates** dialog to add, remove, and manage certificates used in 802.1x and other protected networks.

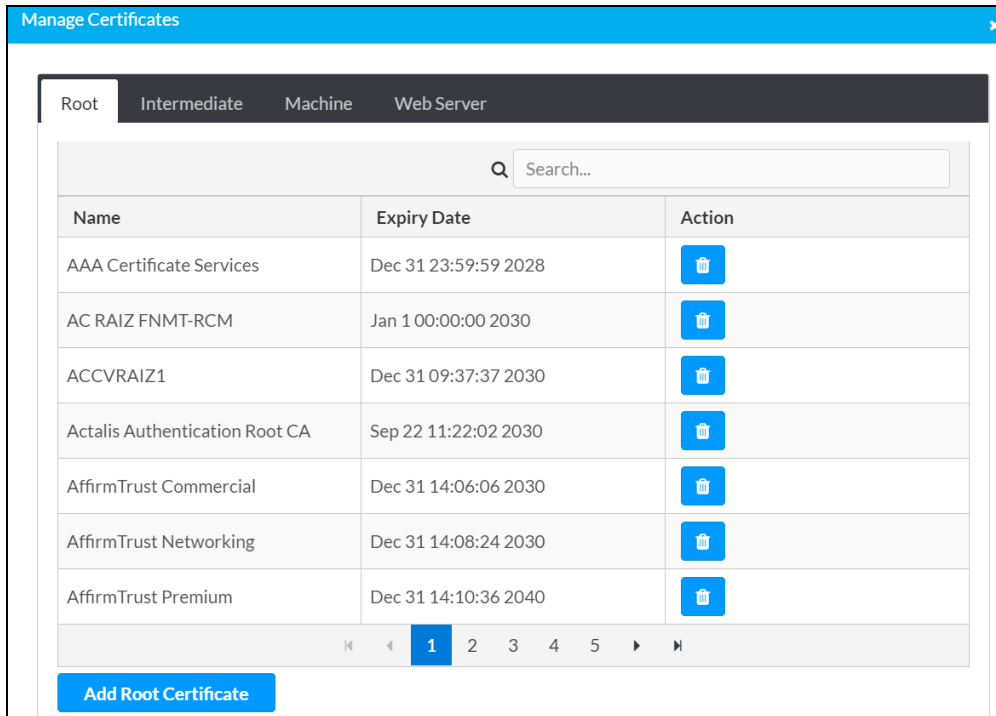

Select **Manage Certificates** in the **Action** drop-down menu. The following certificate tabs are displayed:

- **Root:** The Root certificate is used by the DM-NAX-AMP-X300 to validate the network's authentication server. The DM-NAX-AMP-X300 has a variety of Root certificates, self-signed by trusted CAs (Certificate Authorities) preloaded into the device. Root certificates must be self-signed.
- **Intermediate:** The Intermediate store holds non self-signed certificates that are used to validate the authentication server. These certificates will be provided by the network administrator if the network does not use self-signed Root certificates.
- **Machine:** The machine certificate is an encrypted PFX file that is used by the authentication server to validate the identity of the DM-NAX-AMP-X300. The machine certificate will be provided by the network administrator, along with the certificate password. For 802.1x, only one machine certificate can reside on the device.
- **Web Server:** The Web Server certificate is a digital file that contains information about the identity of the web server.

To Add Certificates

1. Select the corresponding certificate tab.
2. Select **Add Root Certificate**.
3. Select **+ Browse**.
4. Locate and select the file, then select **Open**.

NOTE: If the certificate is a Machine Certificate, enter the password provided by the network administrator.

5. Select **OK**. This will add the certificate to the list box, displaying the file name and expiration date. The certificate is now available for selection and can be loaded to the device.

To Delete Certificates

1. Select the corresponding certificate tab.
2. Select the trashcan icon  in the **Actions** column to delete the certificate.
3. Select **Yes** when prompted to delete the certificate or **No** to cancel the deletion.

Status

The **Status** page is the first page displayed when opening the interface of the DM-NAX-AMP-X300. It displays general information about the DM-NAX-AMP-X300 (such as **Model Name**, **Firmware Version**, and **Serial Number**), current network settings (such as **Host Name** and **IP Address**, etc.), and input and output ports' current status.

The **Status** page can be accessed at any time by selecting the **Status** tab of the DM-NAX-AMP-X300 interface.

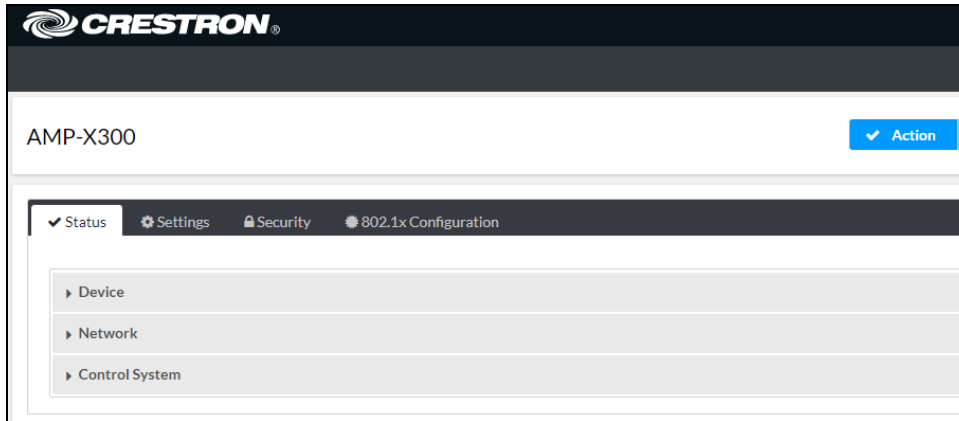

Information displayed on the **Status** tab is organized into different sections.

Device

The **Device** section displays the **Model**, **Firmware Version**, and **Serial Number** of the DM-NAX-AMP-X300.

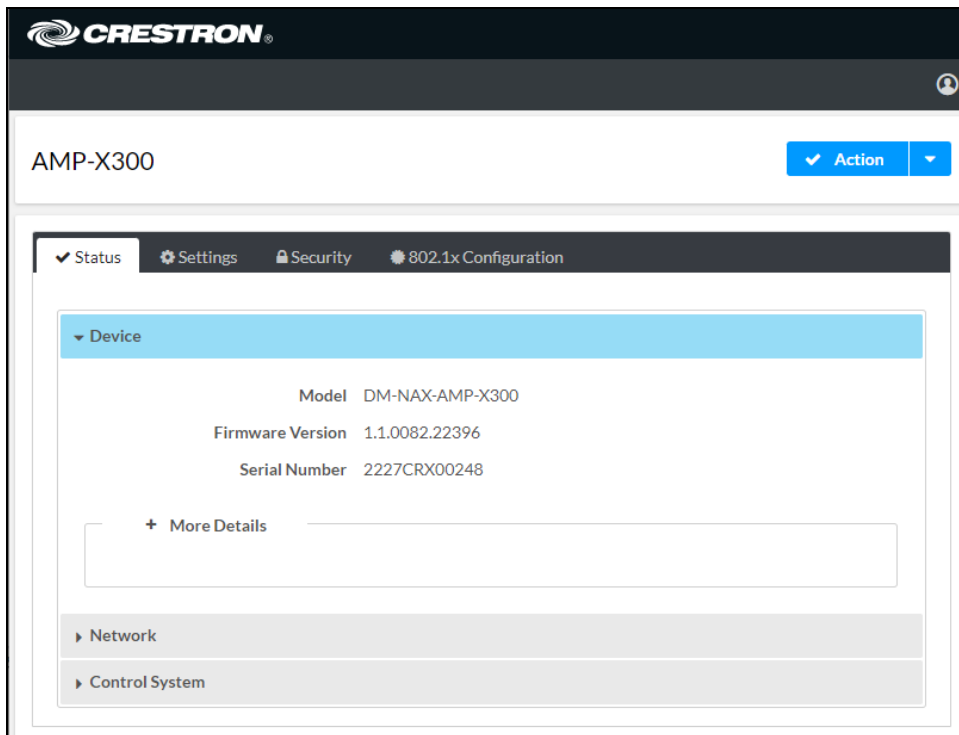

Select **+ More Details** to review additional information about the DM-NAX-AMP-X300.

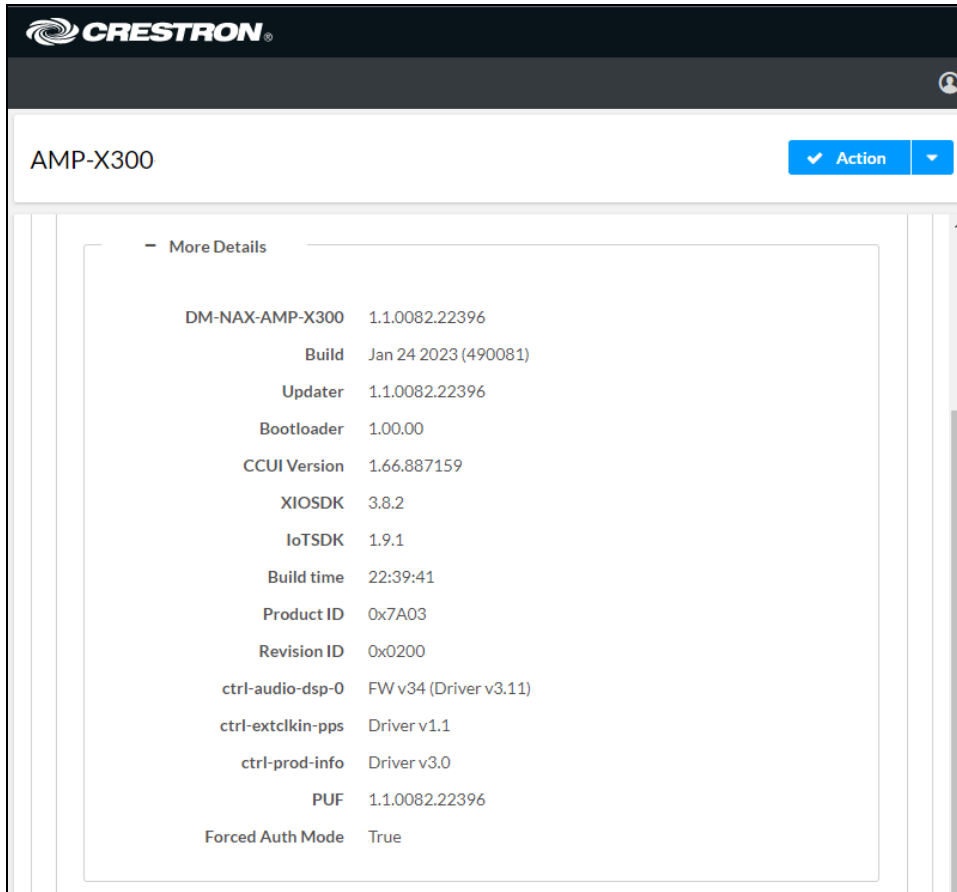

The screenshot shows the Crestron AMP-X300 web interface. At the top, there is a dark header with the Crestron logo and a user profile icon. Below the header, the page title 'AMP-X300' is displayed on the left, and a blue 'Action' dropdown menu is on the right. The main content area is titled 'More Details' and contains a list of system parameters and their values.

DM-NAX-AMP-X300	1.1.0082.22396
Build	Jan 24 2023 (490081)
Updater	1.1.0082.22396
Bootloader	1.00.00
CCUI Version	1.66.887159
XIOSDK	3.8.2
IoTSDK	1.9.1
Build time	22:39:41
Product ID	0x7A03
Revision ID	0x0200
ctrl-audio-dsp-0	FW v34 (Driver v3.11)
ctrl-extclkkin-pps	Driver v1.1
ctrl-prod-info	Driver v3.0
PUF	1.1.0082.22396
Forced Auth Mode	True

Network

The **Network** section displays network-related information about the DM-NAX-AMP-X300, including the **Hostname**, **Domain Name**, and **DNS Servers**.

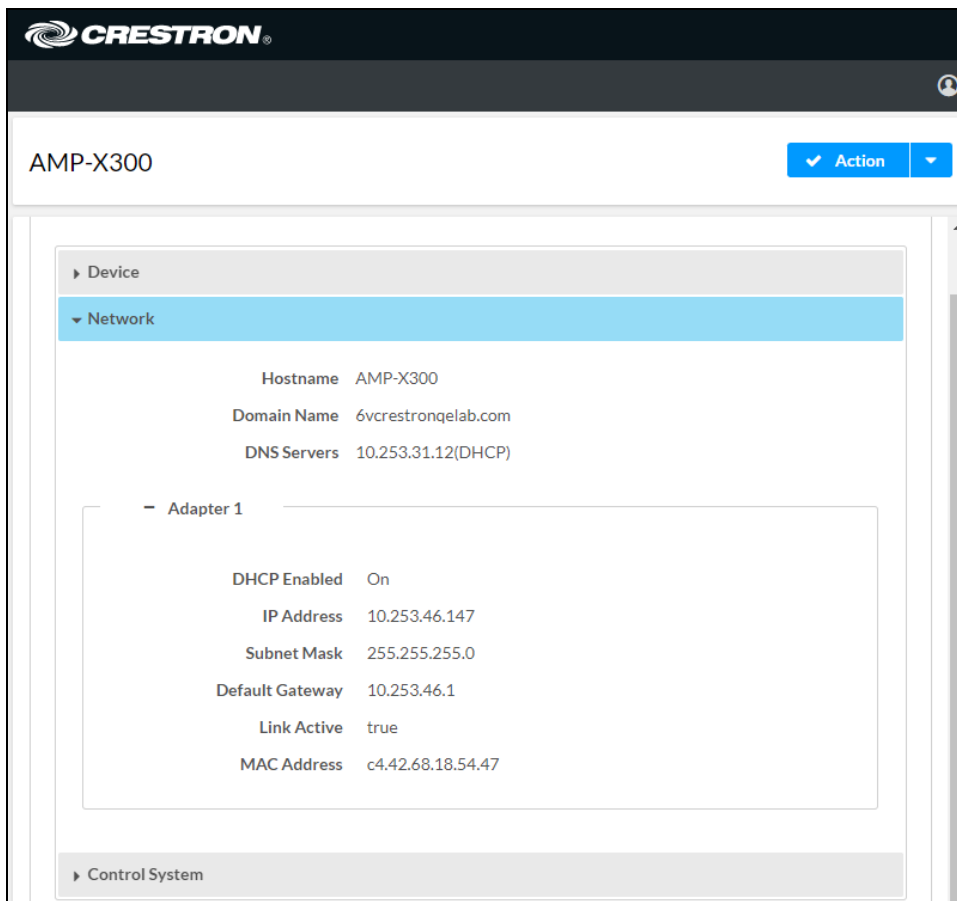

NOTE: By default, the host name of the DM-NAX-AMP-X300 consists of the model name followed by the MAC address of the device. For example, DM-NAX-AMP-X300-00107FB58088.

Select **+ Adapter 1** to display an expanded section that shows additional information. If **+ Adapter 1** is selected, select **- Adapter 1** to collapse the section.

NOTE: The **+ Adapter 2** option appears when the dual Ethernet ports on the DM-NAX-AMP-X300 are set to isolate traffic using the **Port Selection** feature. Refer to [Commercial Mode on page 397](#) or [Residential Mode on page 418](#) for details on configuring the **Port Selection** feature.

Control System

The **Control System** section displays connection information, consisting of the following:

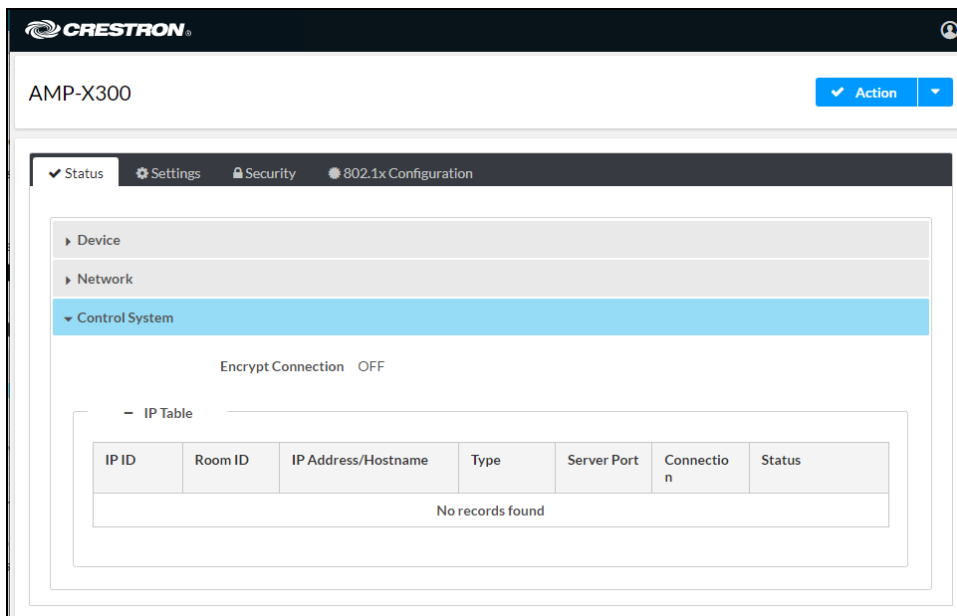

- **Encrypt Connection:** ON or OFF
- **IP ID:** Reports the currently used IP ID of the DM-NAX-AMP-X300
- **IP Address/Hostname:** The IP address of the control system
- **Room ID:** Displays the room ID
- **Status:** OFFLINE or ONLINE

Settings

The **Settings** page enables configuration of the DM-NAX-AMP-X300 settings. The **Settings** page can be accessed at any time by selecting the **Settings** tab of the DM-NAX-AMP-X300 interface.

Many options in the **Settings** page are exclusive to a specific device mode: Residential or Commercial. The DM-NAX-AMP-X300 is in Commercial mode by default.

This section provides the following information:

- [Commercial Mode on page 397](#)
- [Residential Mode on page 418](#)

Commercial Mode

This section provides the following information:

- [System Setup on page 397](#)
- [Commissioning on page 403](#)
- [Output Channels on page 403](#)
- [Input Channels on page 409](#)
- [DM NAX Streams on page 410](#)
- [Port Selection on page 413](#)
- [Mixing on page 414](#)

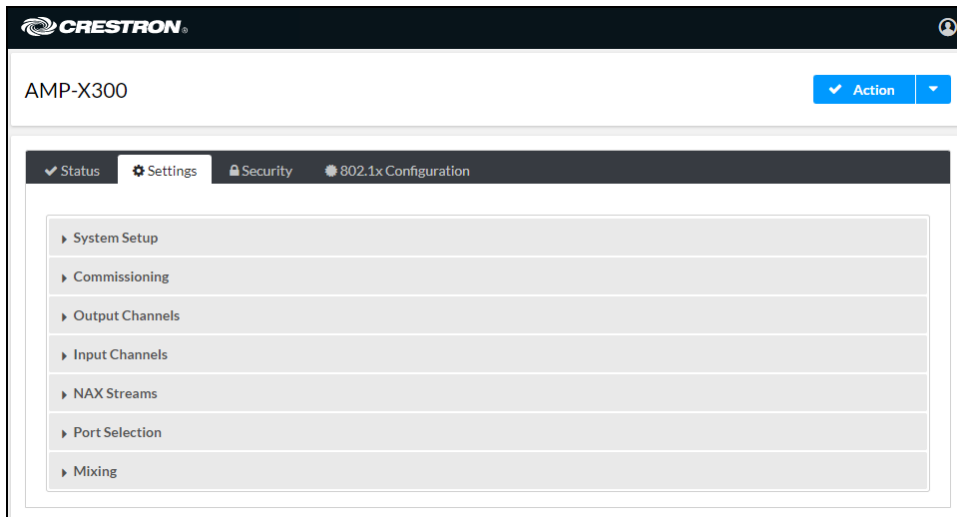

System Setup

The **System Setup** section contains settings for **Date/Time**, **Auto Update**, **Network**, **Control System**, **Cloud Settings**, and **Device Modes**.

Date/Time

Use the **Date/Time** section to configure the date and time settings of the DM-NAX-AMP-X300.

- Date/Time



Synchronization

Time Synchronization

 Synchronize Now

NTP Time Servers

<input type="checkbox"/>	Address	Port	Authentication Method	Authentication Key	Key ID
<input type="checkbox"/>	pool.ntp.org	123	None	0

 Add  Remove

Configuration

Time Zone: (UTC-05:00) Eastern Time (US & ...)

Date: 01/26/2023

Time: 08:37

Time Synchronization

1. Set the **Time Synchronization** toggle to the right position to enable or left position to disable time synchronization. By default, time synchronization is enabled.
2. In the **NTP Time Servers** table, enter the URL of a NTP (Network Time Protocol) or SNTP (Simple Network Time Protocol) server. Up to three time servers can be added on a device.
3. Select **Synchronize Now** to perform time synchronization between the device's internal clock and the time server.

Time Configuration

1. Open the **Time Zone** drop-down menu to select the applicable time zone.
2. In the **Date** field, enter the current date.
3. In the **Time (24hr Format)** field, enter the current time in 24-hour format.

Select **Save Changes** to save the settings.

Select **Revert** from the **Action** drop-down menu to revert to the previous settings without saving.

Auto Update

The DM-NAX-AMP-X300 can automatically check for and install firmware updates at scheduled intervals via the Auto Update feature.

The screenshot shows the 'Auto Update' configuration page. At the top, there is a section for 'Auto Update' with a green toggle switch turned on. Below it is a 'Custom URL' section with a grey toggle switch turned off and a text box containing 'https://crestrondevicefiles.blob.core'. The 'Schedule' section includes a 'Day of Week' dropdown menu set to 'Daily', a 'Time of Day' text box with '02:23', and a 'Poll Interval' text box with '0' and 'Minutes' next to it. A blue 'Update Now' button is located at the bottom of the form.

1. Set the **Auto Update** toggle to the right position to enable Auto Update.
2. Define the URL to download the updates by doing either of the following:
 - a. Use the default URL to download the updates from the Crestron server.
 - b. Use a custom URL. Set the **Custom URL** toggle to the right position to enable a custom URL. In the **Custom URL Path** text box, enter the path to a custom manifest file in the FTP or SFTP URL format. Use the Crestron Auto Update Tool to generate a custom manifest file, then store the file on an FTP (File Transfer Protocol) or SFTP (Secure File Transfer Protocol) server.
3. Set a schedule for the automatic firmware update by doing either of the following:
 - a. Select the desired **Day of Week** and **Time of Day** (24-hour format) values.
 - b. Set the **Poll Interval** by entering a value from **60** to **65535** minutes. A value of **0** disables the Poll Interval.
4. Select **Save Changes**.

Selecting **Update Now** causes the device to check for a firmware update immediately. If a schedule was set in step 4 above, that schedule still remains in effect.

Network

The **Network** section contains network-related settings for the DM-NAX-AMP-X300, including the Hostname, Domain, Primary Static DNS, and Secondary Static DNS.

Network

Hostname * AMP-X300-TECH-DOCS

Domain 6vcrestronqelab.com

Primary Static DNS 10.253.31.12(DHCP)

Secondary Static DNS

Adapter 1

DHCP

IP Address 10.253.46.147

Subnet Mask 255.255.255.0

Default Gateway 10.253.46.1

NOTE: By default, the hostname of the DM-NAX-AMP-X300 consists of the model name followed by the MAC address of the device. For example, DM-NAX-AMP-X300-00107FB58088.

Adapter 1

The Adapter 1 subheading contains settings for **DHCP**, **IP Address**, **Subnet Mask**, and **Default Gateway** of Ethernet adapter 1 on the rear panel of the device.

NOTES:

- An **+ Adapter 2** option only appears when the dual Ethernet ports on the DM-NAX-AMP-X300 are set to isolate traffic using the Port Selection feature. The settings for Adapter 2 are identical to those available for Adapter 1.
- DM NAX devices' internal processes use IP addresses in the 10.10.10.xxx range. This IP range should be avoided when addressing DM NAX devices to prevent conflicts with these internal addresses.

Set the **DHCP** toggle to enabled (right) or disabled (left) to specify whether the IP address of the DM-NAX-AMP-X300 is to be assigned by a DHCP (Dynamic Host Configuration Protocol) server.

- **Enabled:** When DHCP is enabled (default setting), the IP address of the DM-NAX-AMP-X300 is automatically assigned by a DHCP server on the local area network (LAN).
- **Disabled:** When DHCP is disabled, manually enter information in the following fields:
 - **Primary Static DNS:** Enter a primary DNS IP address.
 - **Secondary Static DNS:** Enter a secondary DNS IP address.
 - **IP Address:** Enter a unique IP address for the DM-NAX-AMP-X300.
 - **Subnet Mask:** Enter the subnet mask that is set on the network.
 - **Default Gateway:** Enter the IP address that is to be used as the network's gateway.

To save any new network entries, select **Save Changes**.

Control System

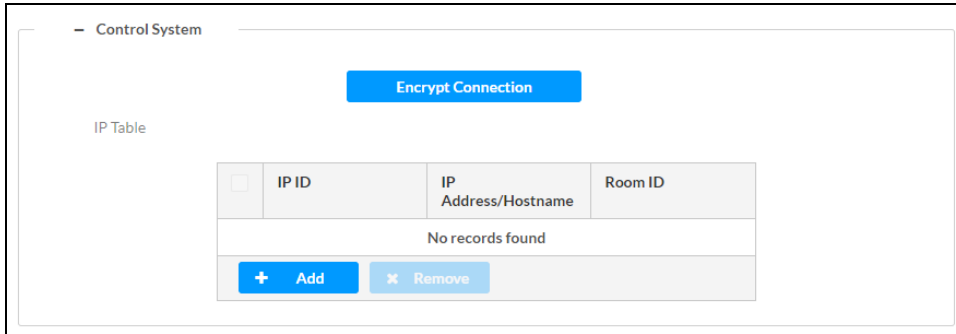

1. Select **Encrypt Connection** to navigate to the **Security** tab to configure encryption settings.
 - a. Enter a username in the **Control System Username** field.
 - b. Enter a password in the **Control System Password** field.
2. Select **+ Add** to add an IP table entry to the **IP Table**.
 - a. Enter the Room ID in the **Room ID** field.
 - b. Enter the IP ID of the DM-NAX-AMP-X300 in the **IP ID** field.
 - c. Enter the IP address or hostname of the control system in the **IP Address/Hostname** field.
3. Select **Save Changes** to save the new entries. The **Control System Save** message box appears, indicating that the control system settings were saved successfully. Select **Revert** to revert to the previous settings without saving.

Cloud Settings



Set the **Cloud Settings** toggle to enabled (right) or disabled (left) to specify whether the DM-NAX-AMP-X300 can communicate with the XiO Cloud® platform.

Device Modes

Use the **Device Modes** section to configure the **Application Mode**, **Audio-Over-IP Mode**, and **Standby Mode**, as well as see a live status readout of the device's rear panel functionality.

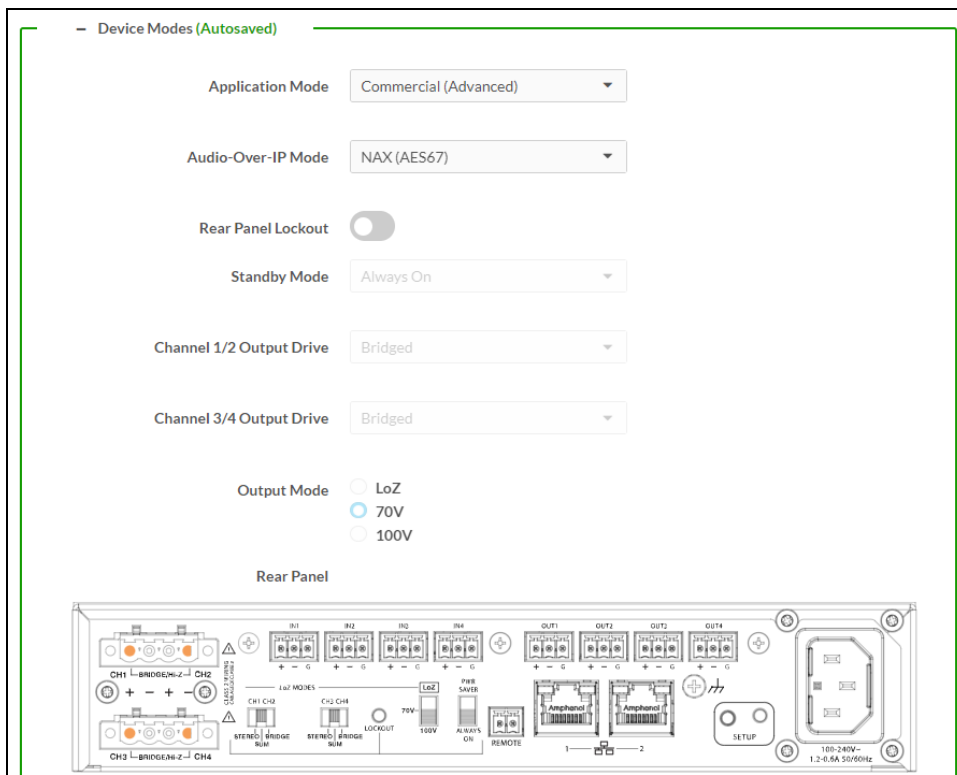

- **Application Mode:** The Application Mode determines which options and controls are available.
 - Select **Residential (Standard)** or **Commercial (Advanced)**. A **Reboot** confirmation message box appears.

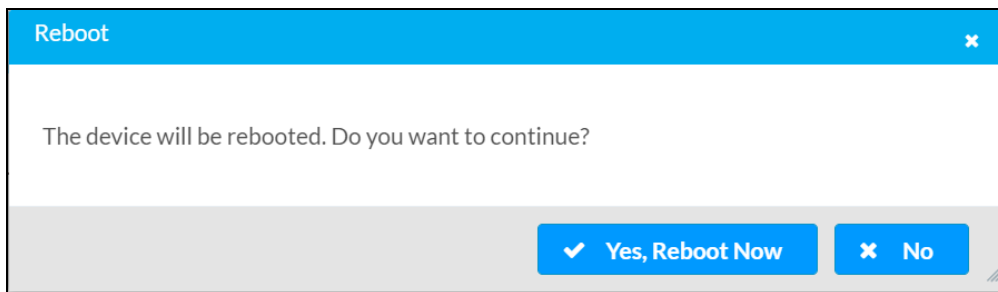

- Select **Yes, Reboot Now** to reboot the device into the selected mode. The **Reboot** message box appears.
 - Wait for the device reboot to complete before attempting to reconnect to the device.
- **Audio Over IP Mode:** Select **NAX (AES67)** or **Dante** to specify what type of audio-over-IP streams the DM-NAX-AMP-X300 will accept and transmit.

NOTE: In NAX (AES67) mode, the DM-NAX-AMP-X300 can still accept streams from Dante devices by way of the AES67 Compatibility Mode feature, which can be enabled on most Dante devices.

- **Rear Panel Lockout:** Set the **Rear Panel Lockout** toggle to specify whether the physical controls on the rear panel are locked (right) or functional (left). When locked, all device controls are handled through this menu.
- **Standby Mode:** Select the DM-NAX-AMP-X300's standby behavior.
 - **Always On:** The device's amplifier remains powered on at all times.
 - **Power Saver:** If no signal is detected for 25 minutes, the device enters a low power state by turning off the amplifier board. Upon detecting an audio signal, the amplifier will be turned back on.
- **Channel 1/2 Output Drive:** Set Channel 1/2 to **Standard** or **Bridged**. This option is only selectable when the **Output Mode** is set to **Lo-Z**.
- **Channel 3/4 Output Drive:** Set Channel 3/4 to **Standard** or **Bridged**. This option is only selectable when the **Output Mode** is set to **Lo-Z**.
- **Output Mode:** The DM-NAX-AMP-X300 can be configured to work with 4 Ω and 8 Ω (low impedance or "Lo-Z") loads or a distributed audio (high impedance or "Hi-Z") 70/100V system.
 - **Lo-Z:** Select **Lo-Z** to use the amplifier with 4 Ω or 8 Ω low impedance loudspeakers.
 - **70V:** Select **70V** to use the amplifier in a 70V distributed audio system.
 - **100V:** Select **100V** to use the amplifier in a 100V distributed audio system.

Commissioning

The **Commissioning** section provides a quick way to automatically assign multicast addresses to all of the device's internal audio-over-IP stream transmitters.

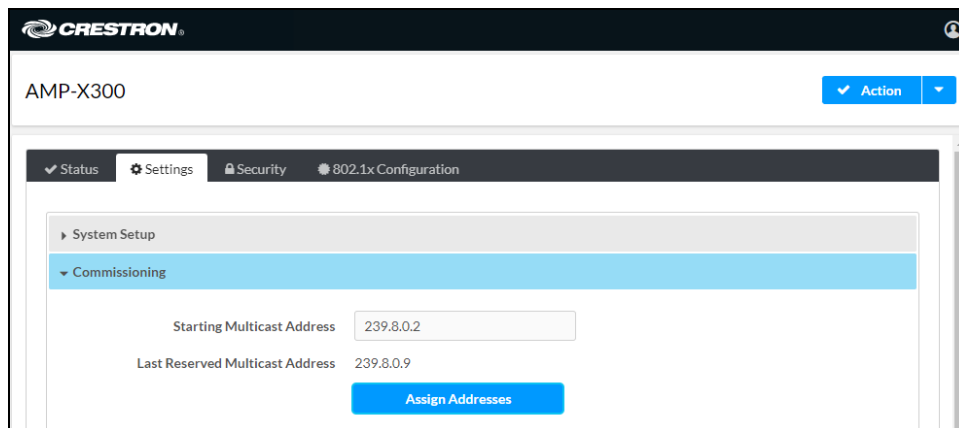

Select **Assign Addresses** to give each DM NAX transmitter in the DM-NAX-AMP-X300 a unique multicast address beginning with the specified **Starting Multicast Address**. The valid range for **Starting Multicast Address** is 239.8.0.0 to 239.127.255.255.

NOTE: This will begin transmitting multicast traffic on your network. Refer to [Audio-over-IP Network Design on page 632](#) for details on proper audio-over-IP network management.

Output Channels

The **Output Channels** section enables the viewing and configuration of Zone outputs.

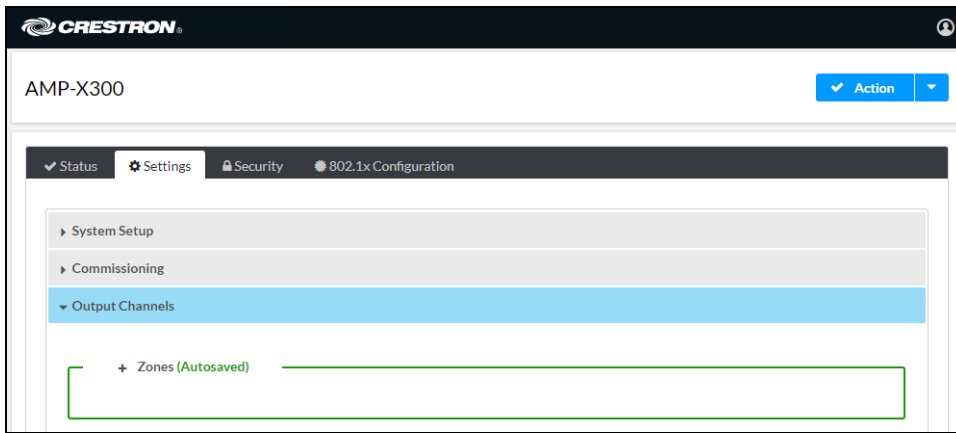

Zones

In the **Zones** section, the properties of each zone can be viewed and configured.

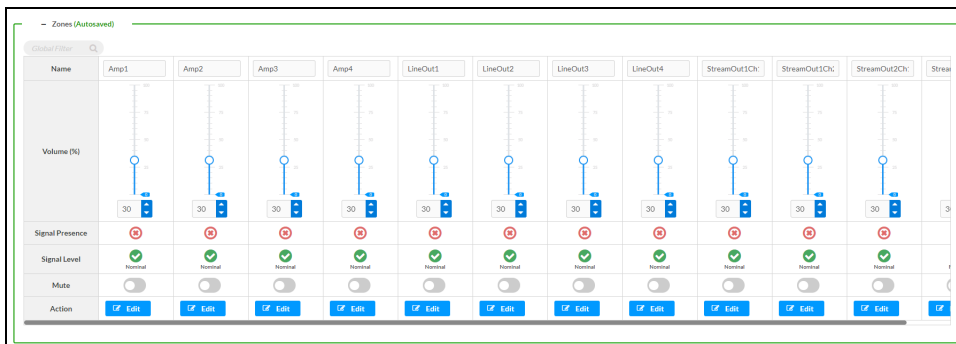

Signal Presence indicates whether or not an audio signal is detected in that zone.

Signal Level indicates if the signal is **Clipping** or **Nominal** (non-clipping).

- **Nominal:** The signal level is within normal operating bounds and below the clipping threshold.
- **Clipping:** The signal level is clipping or above the -3 dB warning threshold and in danger of clipping.

Give each zone a friendly name using the **Name** row of the **Zones** table. If the device is paired with a control system, these names may be overwritten by the control system's program.

To configure the zone volume, do one of the following:

- Move the **Volume** slider up to increase or down to decrease the zone volume.
- Use the **%** arrows to increase or decrease the zone volume. Values range from 0 to 100%, adjustable in increments of 1%.
- Manually enter a value in the **Volume** field.

To mute all audio output from a zone, select its respective **Mute**. To unmute the zone, select **Muted**.

Select **Edit** to view additional **Zone** and **Output** options.

Zone

To configure additional zone settings, select **Edit**. The **Edit Zone** window appears.

Select **Zone** to access the settings for **Tone** and **Delay**.

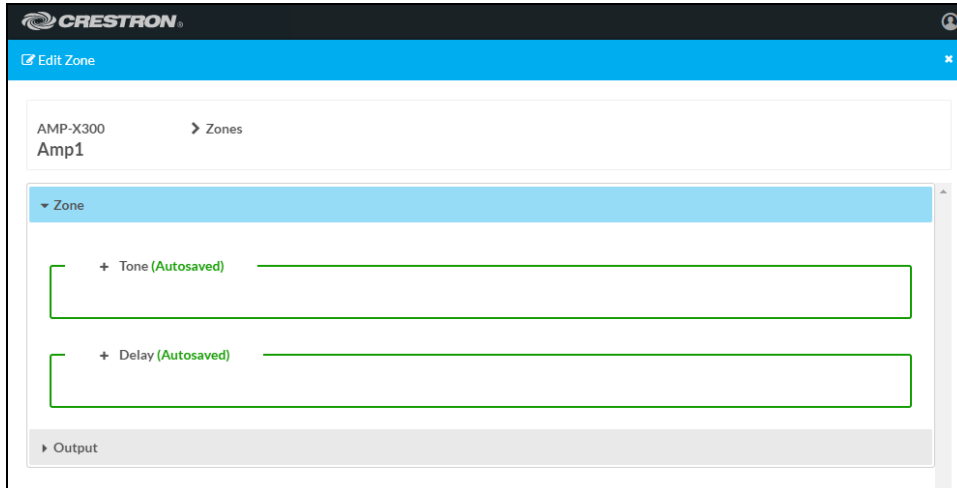

Tone

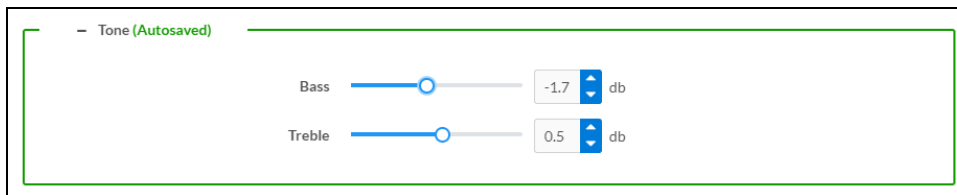

- **Bass:** To adjust the bass, do one of the following:
 - Move the **Bass** slider to the right to increase or to the left to decrease the bass db.
 - Use the **db** arrows to increase or decrease the bass level. Values range from -12 dB to 12 dB, adjustable in increments of .1 dB.
 - Manually enter a value in the **Bass** field.
- **Treble:** To adjust the treble, do one of the following:
 - Move the **Treble** slider to the right to increase or to the left to decrease the treble db.
 - Use the **db** arrows to increase or decrease the treble level. Values range from -12 dB to 12 dB, adjustable in increments of .1 dB.
 - Manually enter a value in the **Treble** field.

Delay

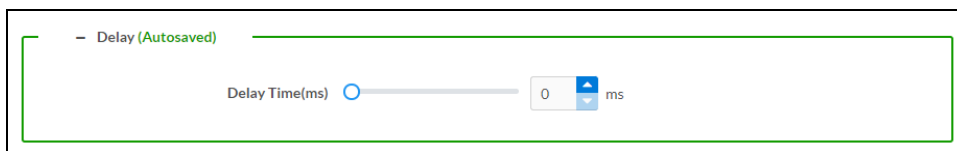

To set the delay, do one of the following:

- Move the **Delay Time(ms)** slider to the right to increase or to the left to decrease the delay time.
- Use the **ms** arrows to increase or decrease the delay. Values range from 0 ms to 250 ms, adjustable in increments of 1 ms.
- Manually enter a value in the **Delay Time(ms)** field.

Output

Select **Output** to access the settings for **Minimum/Maximum**, **Signal**, **Speaker Configuration**, **Speaker/Faults**, and **Equalizer Settings**.

Minimum/Maximum Volume

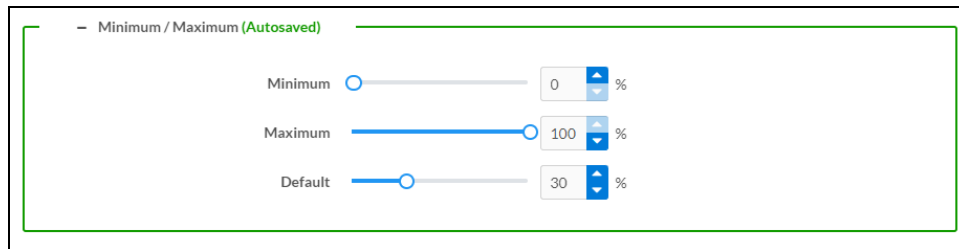

1. To set the minimum volume of the zone, do one of the following:
 - Move the **Minimum** slider to the right to increase or to the left to decrease the minimum volume.
 - Use the **%** arrows to increase or decrease the minimum volume. Values range from 0 to 50%, adjustable in increments of 1%.
 - Manually enter a value in the **Minimum** field.
2. To set the maximum volume of the zone, do one of the following:
 - Move the **Maximum** slider to the right to increase or to the left to decrease the maximum volume.
 - Use the **%** arrows to increase or decrease the maximum volume. Values range from 70 to 100%, adjustable in increments of 1%.
 - Manually enter a value in the **Maximum** field.

NOTE: When a **Minimum** and **Maximum** volume are set, the 1-100% range represented by the **Zone** and **Default** volume controls are scaled to the range set. For example, if a **Minimum** of 10% and a **Maximum** of 80% are set for a zone, the 1-100% range of the **Zone** volume control is scaled to the 10%-80% range set as the **Minimum** and **Maximum**.

3. To set the default volume of the zone, do one of the following:
 - Move the **Default** slider to the right to increase or to the left to decrease the default volume.
 - Use the **%** arrows to increase or decrease the default volume. Values range from 0 to 50%, adjustable in increments of 1%.
 - Manually enter a value in the **Default** field.

NOTE: The **Default** volume is applied as the **Zone** volume any time the zone receives a source route and no source was previously routed to that zone.

Signal

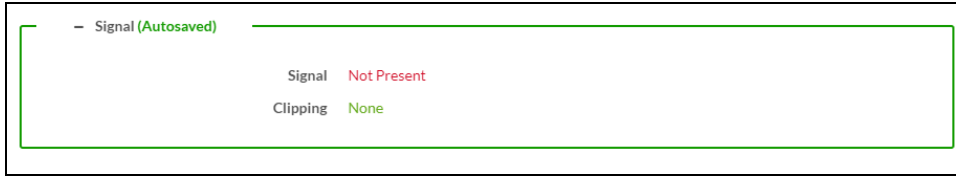

The **Signal** section is a read-only field that displays the **Signal** and **Clipping** status of the zone output.

- If an output signal is present but not clipping, **Signal** will display **Present** in green and **Clipping** will display **None** in green.
- If an output signal is present and clipping, **Signal** will display **Present** in green and **Clipping** will display **Present** in red.
- If no output signal is detected, **Signal** will display **Not Present** in red and **Clipping** will display **None** in green.

Speaker Configuration

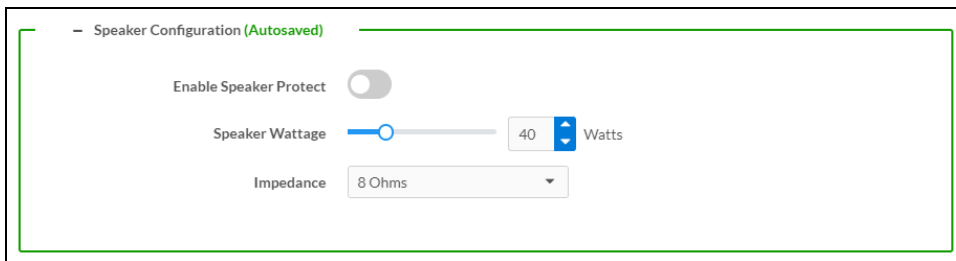

1. Set the **Enable Speaker Protect** toggle to the right position to enable speaker protection for the zone output. Set the toggle to the left position to disable speaker protection. By default, **Enable Speaker Protect** is set to the left position.
2. To set the maximum output wattage, do one of the following:
 - Move the **Speaker Wattage** slider to the right to increase or to the left to decrease the maximum peak amplifier wattage that can be output to the speaker.
 - Use the **Watts** arrows to increase or decrease the maximum peak amplifier wattage that can be output to the speaker. Values range from 5 W to 150 W, adjustable in increments of 1 W.
 - Manually enter a value in the **Speaker Wattage** field.
3. Select the impedance of the speaker on a selected zone from the **Impedance** drop-down menu. Values are **4 Ohms**, **8 Ohms**, and **Bridged**.

Speaker Faults

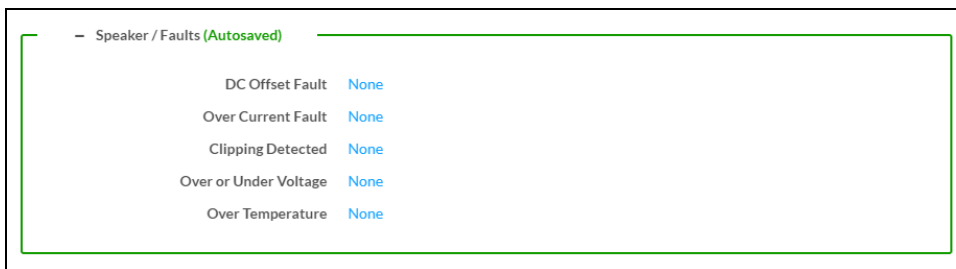

The Speaker/Faults section is a read-only field that displays the status of the **DC Offset Fault**, **Over Current Fault**, **Clipping Detected**, **Over or Under Voltage**, and **Over Temperature** detectors for the zone output. If clipping or a given fault type is detected, then its corresponding readout displays **Fault Detected** in red. Otherwise, it displays **None** in blue.

Equalizer Settings

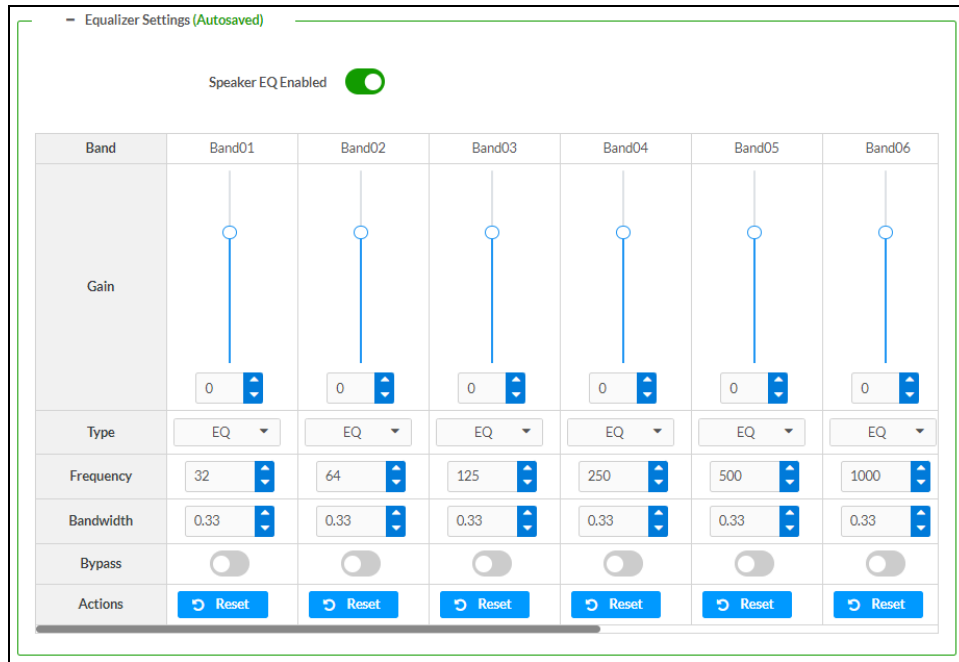

Each zone output of the DM-NAX-AMP-X300 has a dedicated ten-band equalizer that can be fully customized to tune the zone output signal to the needs of an install. Each band can have a discrete gain, filter type, center frequency, and bandwidth set, and can also be bypassed. The equalizer itself can also be bypassed using the **Speaker EQ Enabled** toggle.

1. Set the **Speaker EQ Enabled** toggle to the right position to enable the equalizer. Set the toggle to the left position to bypass the equalizer.

NOTE: When **Speaker EQ Enabled** is disabled, all equalizer bands are bypassed. This is a quick way to perform A/B testing of the entire EQ curve.

2. With the **Speaker EQ Enabled** toggle in the right position, configure the equalizer bands.
 - a. To set a band's gain, do one of the following:
 - Move the **Gain** slider up to increase or down to decrease the gain.
 - Use the arrows to increase or decrease the gain. Values range from -40 dB to 20 dB, adjustable in increments of 0.1 dB.
 - Manually enter a value in the **Gain** field.

- b. Select a filter type from the **Type** drop-down menu. By default, all bands are set to the **EQ** filter type. Some filter types will disable other settings in their respective band while enabled. For example, selecting the **LowPass** filter type for a band will disable that band's **Gain** and **Bandwidth** settings, since the **LowPass** filter applies a fixed roll-off slope at a set frequency. The available filter types are:
- **EQ:** a fully parametric filter that can boost or cut a range of frequencies.
 - **Notch:** a parametric filter designed to more precisely cut a frequency or range of frequencies. A notch filter can achieve a narrower bandwidth than the standard **EQ** parametric filter type.
 - **TrebleShelf:** a filter that boosts or cuts all frequencies above a set frequency by a set gain.
 - **BassShelf:** a filter that boosts or cuts all frequencies below a set frequency by a set gain.
 - **LowPass:** a filter that fully cuts all frequencies above a set frequency using a fixed roll-off slope of -12 dB per octave.
 - **HighPass:** a filter that fully cuts all frequencies below a set frequency using a fixed roll-off slope of -12 dB per octave.
- c. Set a center frequency for the equalizer band to tune a specific portion of the audible frequency spectrum. To set the center frequency, do one of the following:
- Use the arrows to increase or decrease the frequency. Values range from 20 Hz to 20 kHz, adjustable in increments of 1 Hz. Each band has a default center frequency that will be applied if **Reset** at the bottom of the band is selected.
 - Manually enter a value in the **Frequency** field.
- d. Set a bandwidth to determine how wide of a frequency range is effected by the equalizer band. To set the bandwidth, do one of the following:
- Use the arrows to increase or decrease the bandwidth. Values range from 0.1 octaves to 4.0 octaves, adjustable in increments of 0.1 octave.
 - Manually enter a value in the **Bandwidth** field.
- e. The individual Bypass controls allow you to bypass a single band of equalization at a time for more granular A/B testing of a single filter. Set a band's **Bypass** toggle to the right position to bypass that band. Set the toggle to the left position to disable the bypass. By default, **Bypass** is disabled.
- f. Each equalizer band has a **Reset** that will reapply the default settings for that band.

Select **Done** to return to the **Settings** tab of the web user interface.

Input Channels

The **Input Channels** section enables the viewing and configuration of **Analog Inputs**.

- Analog Inputs (Autosaved)

Name	LineIn1	LineIn2	LineIn3	LineIn4	StreamIn1Ch1	StreamIn1Ch2	StreamIn2Ch1	StreamIn2Ch2
Analog Gain (db)	17	17	17	17				
Compensation (db)								
Signal Present								
Signal Level	 Nominal	 Nominal	 Nominal	 Nominal	 Nominal	 Nominal	 Nominal	 Nominal
Mode	Line	Line	Line	Line				
Phantom Power	<input type="checkbox"/>	<input type="checkbox"/>	<input type="checkbox"/>	<input type="checkbox"/>				
Mute	<input type="checkbox"/>	<input type="checkbox"/>	<input type="checkbox"/>	<input type="checkbox"/>	<input type="checkbox"/>	<input type="checkbox"/>	<input type="checkbox"/>	<input type="checkbox"/>

Signal Presence indicates whether or not a signal is detected in that zone.

Signal Level indicates if the signal is **Clipping** or **Nominal** (non-clipping).

- If needed, enter a friendly name for each input in its **Name** field.
- To set a level compensation adjustment for a given input, do one of the following:
 - Slide the **Compensation** slider up to increase or down to decrease the compensation. Compensation increases the level of the incoming audio signal on any of the physical inputs on the device's rear panel.
 - Use the **db** arrows to increase or decrease the compensation. Values range from -10 dB to 10 dB, adjustable in increments of 0.1 dB.
 - Manually enter a value in the **Compensation** field.
- Use the Mode drop-down to select **Line** or **Mic**.
- If using **Mic Mode**, **Phantom Power** can be enabled by moving the **Phantom Power** toggle to the right. Disable **Phantom Power** by moving the toggle to the left.
- To mute the signal from the corresponding input, select **Mute**. To disable the mute, select **Muted**. By default, **Mute** is disabled.

DM NAX Streams

Each local input of the DM-NAX-AMP-X300 can be made available as a DM NAX audio-over-IP stream.

The DM-NAX-AMP-X300 also supports parallel DM NAX streams for each zone output, enabling an additional transmit stream per output to mirror all routes and DSP settings of its respective zone. These parallel streams enable control of the audio signal to third-party uncontrolled AES67 devices receiving audio from the DM-NAX-AMP-X300.

NOTES:

- Under the **Transmitters** section (see [Configure Transmitters](#)), the last two listed transmitters are dedicated to parallel zone outputs.
- To configure the DSP settings, see [Zone Settings](#).

Select **NAX Streams** to display the following information.

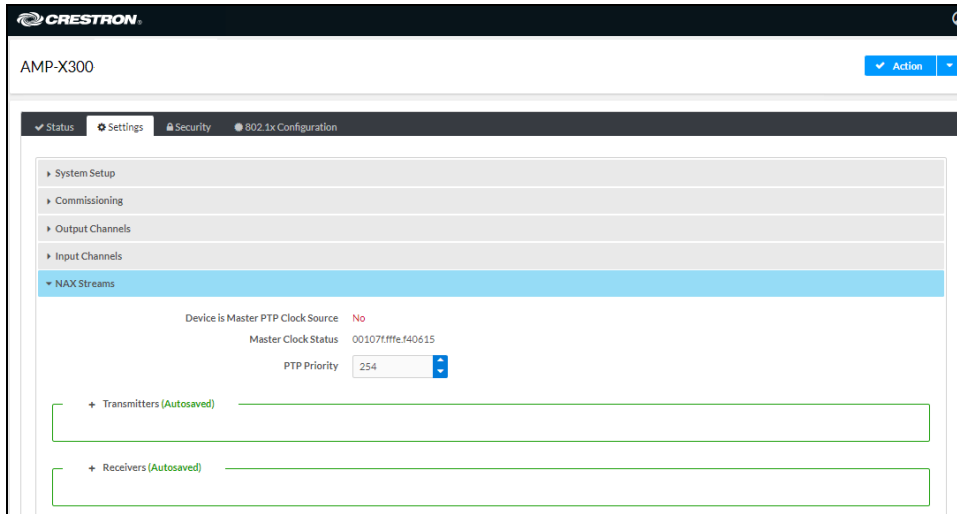

- **Device is Leader PTP Clock Source** indicates whether the device is the leader for PTP on the network. **Yes** will be displayed in green when the local DM-NAX-AMP-X300 is the PTP leader clock and **No** will be displayed in red when another PTP clock on the network is operating as the leader clock.
- **Leader Clock Status** displays the Leader Clock ID of the device on the network that acts as the Leader Clock.
- **PTP Priority**: This sets the priority of the local DM NAX device's PTP clock relative to other clocks on the network. The default setting is 254 (one increment higher than the lowest possible value) so that the DM-NAX-AMP-X300 will only operate as the leader clock if no other PTP leader is present on the network. Valid values range from 1 to 255.

Configure Transmitters

Audio Source	Stream	Nax Stream Address	Nax Stream Name	Status	Actions
IN1-IN2	Stream01	239.8.0.2	Stream01c4.42.68.18.54.47	Stream Started	▶ □ ⚙
IN3-IN4	Stream02	239.8.0.3	Stream02c4.42.68.18.54.47	Stream Started	▶ □ ⚙

To configure a DM NAX transmit stream:





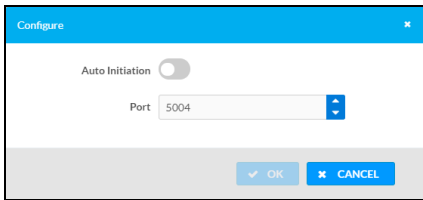

1. Enter a valid multicast address in the **NAX Stream Address** field.
2. Enter a name in the **NAX Stream Name** field by which the stream can be identified. This stream name is associated with the DM NAX stream's multicast address by other DM NAX or AES67 devices, like a device hostname that resolves to a given IP address.

3. **Status** indicates whether a stream is transmitting or not. When the stream has started or stopped, the **Status** column will update accordingly.
4. Select the configure icon  in the **Actions** column. The **Configure** dialog appears:



5. Set the **Auto Initiation** toggle to the right position to enable auto initiation. Set the toggle to the left position to disable auto initiation.
 - If **Auto Initiation** is enabled for a given stream, the stream will begin transmitting automatically and will be available as a multicast stream on your network at the specified multicast address.
 - If **Auto Initiation** is disabled for the input, the stream will not begin transmitting until it is manually initiated.
6. To set the port number, do one of the following:
 - Use the arrows to increase or decrease the port number by increments of 1.
 - Manually enter a port number in the **Port** field. The default port number for DM NAX streams is 5004.
7. Select **OK** to save or select **Cancel** to cancel the changes.

Configure Receivers

Zone Name	Stream	Current Stream Address	Requested Stream Address	Status	Actions
Zone_Amp1	Stream01	0.0.0.0	0.0.0.0	Stream Stopped	  
Zone_Amp2	Stream02	0.0.0.0	0.0.0.0	Stream Stopped	  

1. Enter the multicast address of a transmitting stream in the **Requested Stream Address** field to subscribe the receiver to the stream.
2. Select the configure icon  in the **Actions** column. The **Configure** dialog appears:

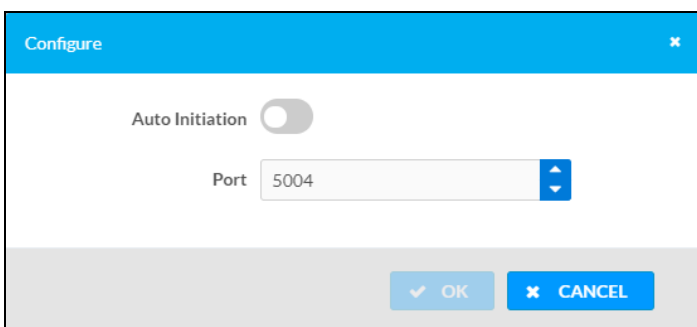

3. Set the **Auto Initiation** toggle to the right position to enable auto initiation. Set the toggle to the left position to disable auto initiation.
 - If **Auto Initiation** is enabled, the stream will begin automatically when the receiver subscribes to the transmitter.
 - If **Auto Initiation** is disabled, the stream will not begin until it is manually initiated.
4. To set the port number, do one of the following:
 - Use the arrows to increase or decrease the port number by increments of 1.
 - Manually enter a port number in the **Port** field. The default port number is 5004.
5. Select **OK** to save or select **Cancel** to cancel the changes.

Port Selection

The **Port Selection** feature allows the device's internal network traffic to be managed and segregated based on traffic type. Internal VLANs are used to segment device management and streaming service traffic to a separate physical device Ethernet port than audio-over-IP streaming traffic. With **Port Selection** enabled on all DM NAX devices on a network, DM NAX and AES67 network traffic can be physically separated from the control network onto a dedicated audio network.

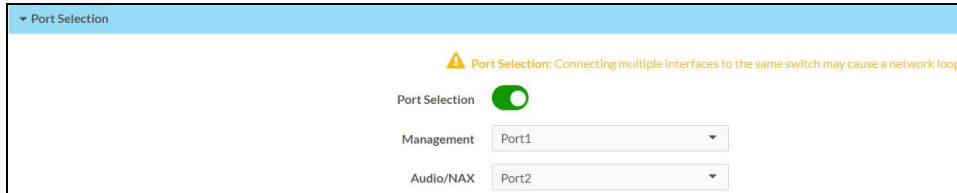

To configure **Port Selection**:

1. Set the **Port Selection** toggle to the right position to enable Port Selection. Set the toggle to the left position to disable Port Selection. By default, **Port Selection** is disabled.

NOTE: **Port1** and **Port2** correspond to the Ethernet adapters labeled **1** and **2** on the rear panel of the DM-NAX-AMP-X300, respectively.

2. With **Port Selection** enabled:
 - a. Select an Ethernet port from the **Management** drop-down menu to designate which Ethernet port on the rear panel of the device will handle network traffic relating to device configuration and the device's connection to a control system.

NOTE: The **Management** port determines your connection to the web interface. Changing the port value can result in losing your connection to the device via the web interface.

- b. Select an Ethernet port from the **Audio/NAX** drop-down menu to designate which Ethernet port on the rear panel of the device will handle audio-over-IP streaming network traffic.
3. Select **Save** changes to apply the new settings.

NOTE: Making changes to **Port Selection** settings will require a reboot.

Mixing

This section contains the **Mixing** and **Ducking** matrices.

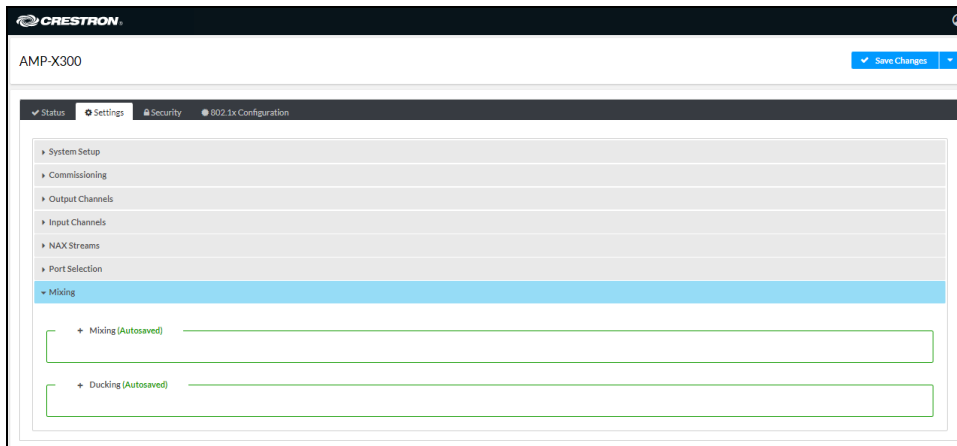



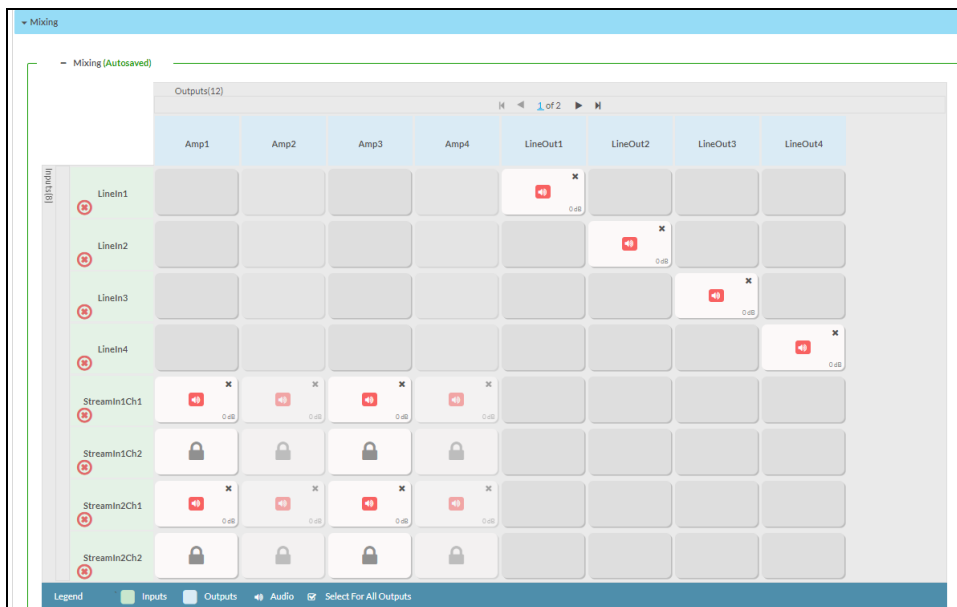

Mixing

The **Mixing** matrix is used to route a local input or AES67 stream to an output on the DM-NAX-AMP-X300.



To route inputs to outputs on the device:

- Select the cells corresponding to the desired output that are to be paired for routing. Once a route is made,  appears. The input that you have selected for a given row will route to the output corresponding to that row in the matrix.
- Use the arrows ( or ) at the top of the matrix to change pages to view all available inputs.
- To break a given route select  or .
- Lock icons appear on any routes that are already configured in the **Ducking** matrix.

Each output can have any number of inputs routed to it. To adjust the mix setting for a route, select the **dB** value of the cell, then do one of the following:

- Move the slider up to increase or down to decrease the mix level.
- Use the arrows to increase or decrease the mix level.
- Manually enter a value in the field.

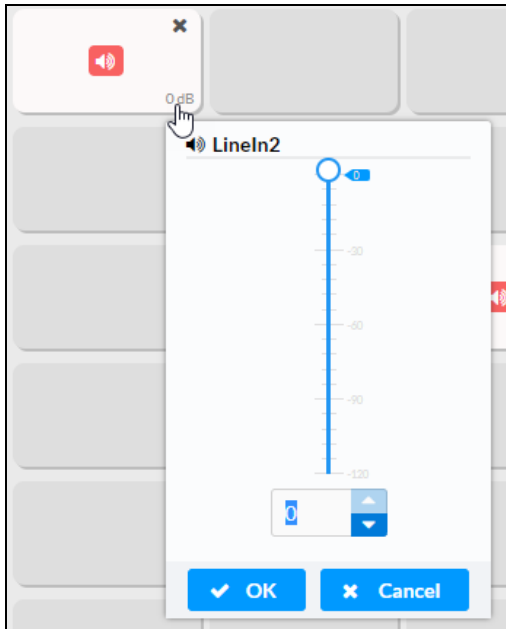



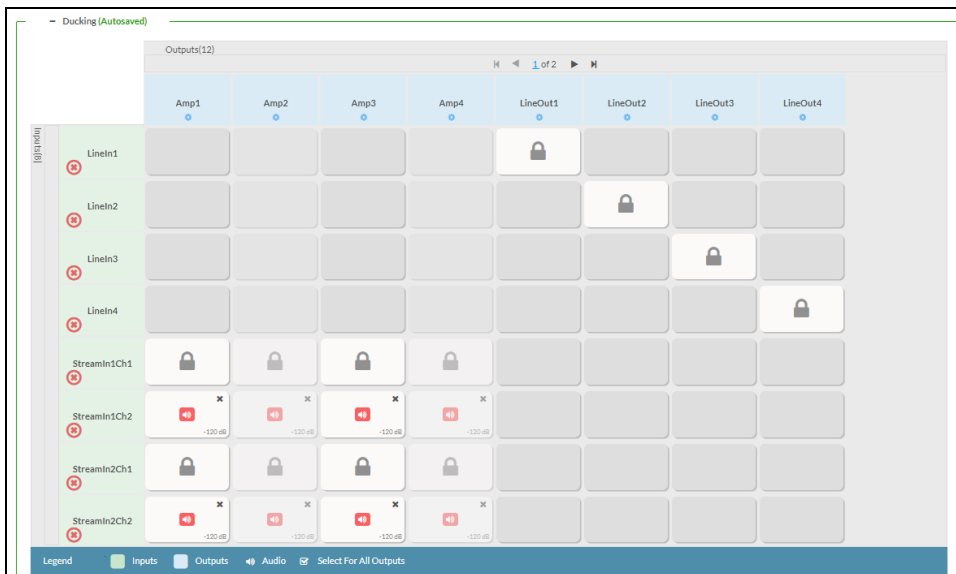

Ducking

The **Ducking** matrix is used to configure ducking routes. Audio signals on these routes will duck audio signals on the **Mixing** routes for a given output whenever the ducking signal exceeds the ducking threshold.





To assign inputs as ducking signals for zones on the device:

- Select the cells corresponding to the desired zone that are to be paired for ducking. Once a route is made,  appears. The input that you have selected for a given row will route to the zone corresponding to that row in the matrix, and will duck any other signals routed to that zone in the **Mixing** matrix.
- Use the arrows ( or ) at the top of the matrix to change pages to view all available inputs.
- To break a given route select  or .
- Lock icons appear on any routes that are already configured in the **Mixing** matrix.

Each output can have any number of inputs routed to it. To adjust the mix setting for a route, select the **dB** value of the cell, then do one of the following:

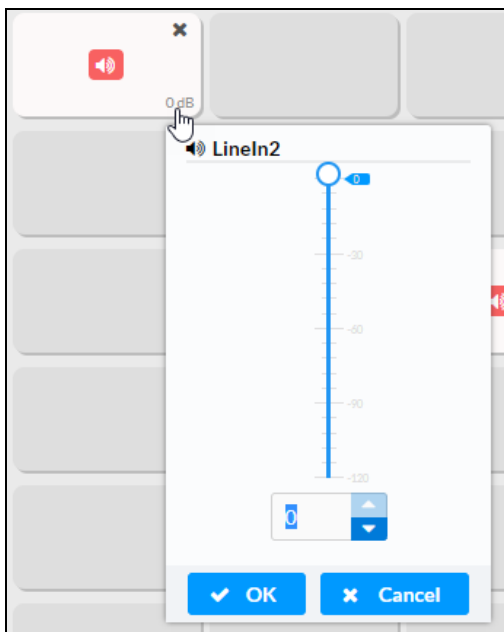
- Move the slider up to increase or down to decrease the mix level.
- Use the arrows to increase or decrease the mix level.
- Manually enter a value in the field.



To configure the **Ducker** settings for a given output, select the configure icon  below it.

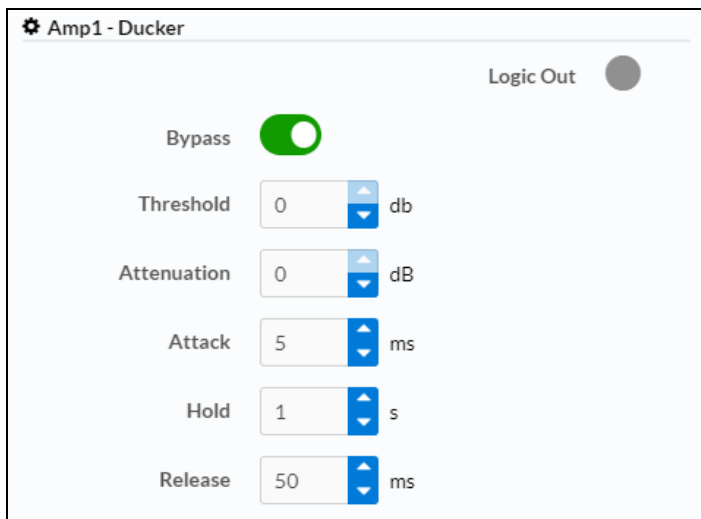

Logic Out: This indicator turns blue when the ducker is active.

Bypass: Set the **Bypass** toggle to the right position to bypass the ducker. Set the toggle to the left to enable the ducker.

Threshold: Set the dB value at which the ducker engages. Use the arrows or enter a number to set the dB value for the **Threshold**. Values range from 0 dB to -60 dB.

Attenuation: Set the dB value by which the **Mixing** matrix output signals will be reduced when ducking is triggered. Use the arrows or enter a number to set the dB value for the **Attenuation**. Values range from 0 dB to -80 dB.

Attack: Set how quickly the ducking occurs once triggered. Use the arrows or enter a number to set value in ms for the **Attack**. Values range from 0.1 ms to 2000 ms.

Hold: Set the length of time for which the ducker will stay at full attenuation once the ducking signal passes the **Threshold**. Use the arrows or enter a number to set a value in seconds for the **Hold**. Values range from 0.1 s to 20 s.

Release: Set the time for the **Mixing** matrix output signal to return to its full level after the ducking signal falls below the threshold and the **Hold** time ends. Use the arrows or enter a number to set the value in ms for the **Release**. Values range from 10 ms to 4000 ms.

Residential Mode

This section provides the following information:

- [System Setup on page 419](#)
- [Commissioning on page 423](#)
- [Zones on page 424](#)
- [Bussing on page 436](#)
- [Inputs on page 437](#)
- [NAX Streams on page 437](#)
- [Routing on page 440](#)
- [Port Selection on page 440](#)

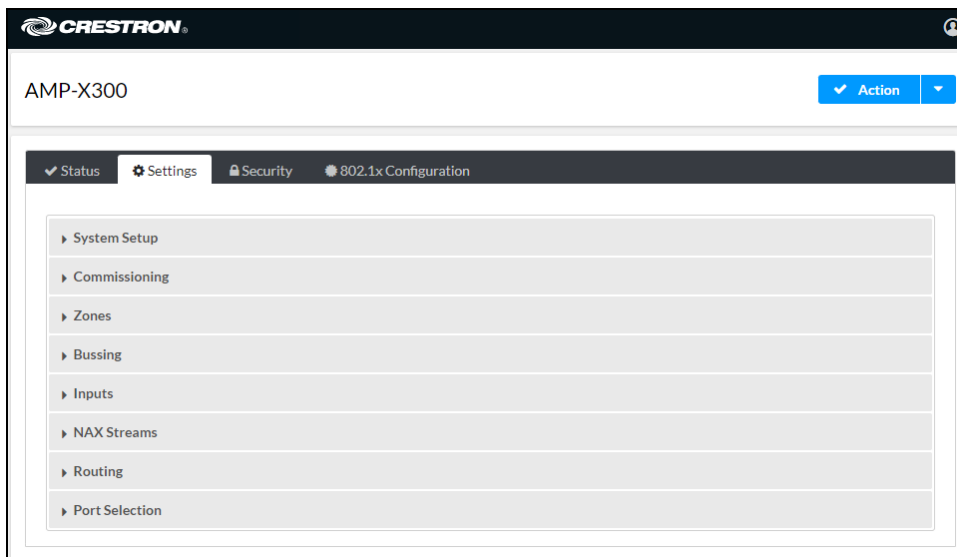

System Setup

The **System Setup** section displays information about the Date/Time, Auto Update, Network, Control System, Cloud Settings, and Device Modes.

Date/Time

Use the **Date/Time** section to configure the date and time settings of the DM-NAX-AMP-X300.

The screenshot shows the 'Date/Time' configuration page. At the top, there is a 'Synchronization' section with a 'Time Synchronization' toggle switch turned on (green) and a blue 'Synchronize Now' button. Below this is the 'NTP Time Servers' section, which contains a table with columns for 'Address', 'Port', 'Authentication Method', 'Authentication Key', and 'Key ID'. A single server is listed with 'pool.ntp.org' as the address, '123' as the port, and 'None' as the authentication method. Below the table are '+ Add' and '- Remove' buttons. The 'Configuration' section at the bottom includes a 'Time Zone' dropdown menu set to '(UTC-05:00) Eastern Time (US & ...)', a 'Date' input field with '01/26/2023', and a 'Time' input field with '08:37'.

Time Synchronization

1. Set the **Time Synchronization** toggle to the right position to enable or left position to disable time synchronization. By default, time synchronization is enabled.
2. In the **NTP Time Servers** table, enter the URL of a NTP (Network Time Protocol) or SNTP (Simple Network Time Protocol) server. Up to three time servers can be added on a device.
3. Select **Synchronize Now** to perform time synchronization between the device's internal clock and the time server.

Time Configuration

1. Open the **Time Zone** drop-down menu to select the applicable time zone.
2. In the **Date** field, enter the current date.
3. In the **Time (24hr Format)** field, enter the current time in 24-hour format.

Select **Save Changes** to save the settings.

Select **Revert** from the **Action** drop-down menu to revert to the previous settings without saving.

Auto Update

The DM-NAX-AMP-X300 can automatically check for and install firmware updates at scheduled intervals via the **Auto Update** feature.

The screenshot shows the 'Auto Update' configuration page. At the top, there is a section for 'Auto Update' with a green toggle switch turned on. Below it is a 'Custom URL' section with a grey toggle switch turned off and a text box containing 'https://crestrondevicefiles.blob.core'. The 'Schedule' section includes a 'Day of Week' dropdown menu set to 'Daily', a 'Time of Day' text box set to '02:23', and a 'Poll Interval' text box set to '0' with 'Minutes' written next to it. A blue 'Update Now' button is located at the bottom of the form.

1. Set the **Auto Update** toggle to the right position to enable Auto Update.
2. Define the URL to download the updates by doing either of the following:
 - a. Use the default URL to download the updates from the Crestron server.
 - b. Use a custom URL. Set the **Custom URL** toggle to the right position to enable a custom URL. In the **Custom URL Path** text box, enter the path to a custom manifest file in the FTP or SFTP URL format. Use the Crestron Auto Update Tool to generate a custom manifest file, then store the file on an FTP (File Transfer Protocol) or SFTP (Secure File Transfer Protocol) server.
3. Set a schedule for the automatic firmware update by doing either of the following:
 - a. Select the desired **Day of Week** and **Time of Day** (24-hour format) values.
 - b. Set the **Poll Interval** by entering a value from **60** to **65535** minutes. A value of **0** disables the Poll Interval.
4. Select **Save Changes**.

Selecting **Update Now** causes the device to check for a firmware update immediately. If a schedule was set in step 4 above, that schedule still remains in effect.

Network

The **Network** section contains network-related settings for the DM-NAX-AMP-X300, including the **Hostname**, **Domain**, **Primary Static DNS**, and **Secondary Static DNS**.

Network

Hostname * AMP-X300-TECH-DOCS

Domain 6vcrestronqelab.com

Primary Static DNS 10.253.31.12(DHCP)

Secondary Static DNS

Adapter 1

DHCP

IP Address 10.253.46.147

Subnet Mask 255.255.255.0

Default Gateway 10.253.46.1

NOTE: By default, the host name of the DM-NAX-AMP-X300 consists of the model name followed by the MAC address of the device. For example, DM-NAX-AMP-X300-00107FB58088.

Adapter 1

The **Adapter 1** subheading contains settings for **DHCP**, **IP Address**, **Subnet Mask**, and **Default Gateway** of Ethernet adapter 1 on the rear panel of the device.

NOTES:

- An **+ Adapter 2** option only appears when the dual Ethernet ports on the DM-NAX-AMP-X300 are set to isolate traffic using the **Port Selection** feature. The settings for Adapter 2 are identical to those available for Adapter 1.
- DM NAX devices' internal processes use IP addresses in the 10.10.10.xxx range. This IP range should be avoided when addressing DM NAX devices to prevent conflicts.

Set the **DHCP** toggle to enabled (right) or disabled (left) to specify whether the IP address of the DM-NAX-AMP-X300 is to be assigned by a DHCP (Dynamic Host Configuration Protocol) server.

- **Enabled:** When **DHCP** is enabled (default setting), the IP address of the DM-NAX-AMP-X300 is automatically assigned by a DHCP server on the local area network (LAN).
- **Disabled:** When **DHCP** is disabled, manually enter information in the following fields:
 - **Primary Static DNS:** Enter a primary DNS IP address.
 - **Secondary Static DNS:** Enter a secondary DNS IP address.
 - **IP Address:** Enter a unique IP address for the DM-NAX-AMP-X300.
 - **Subnet Mask:** Enter the subnet mask that is set on the network.
 - **Default Gateway:** Enter the IP address that is to be used as the network's gateway.

To save any new network entries, select **Save Changes**.

Control System

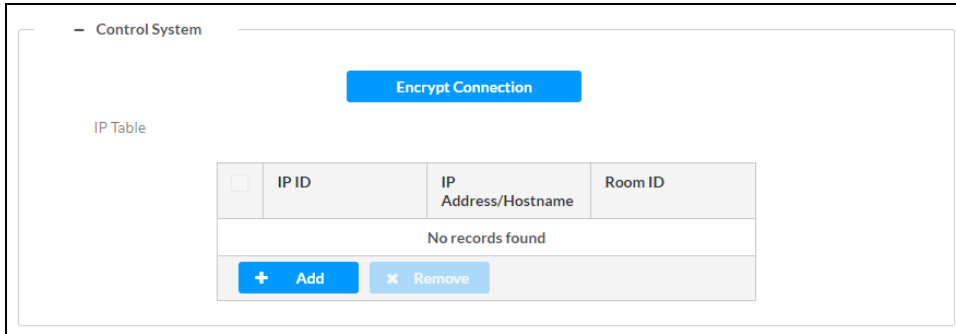

1. Select **Encrypt Connection** to navigate to the **Security** tab to configure encryption settings.
 - a. Enter the username in the **Control System Username** field.
 - b. Enter the password in the **Control System Password** field.
2. Select **+ Add** to add an IP table entry to the **IP Table**.
 - a. Enter the Room ID in the **Room ID** field.
 - b. Enter the IP ID of the DM-NAX-AMP-X300 in the **IP ID** field.
 - c. Enter the IP address or hostname of the control system in the **IP Address/Hostname** field.
3. Select **Save Changes** to save the new entries. The **Control System Save** message box appears, indicating that the control system settings were saved successfully. Select **Revert** to revert to the previous settings without saving.

Cloud Settings



Set the **Cloud Settings** toggle to enabled (right) or disabled (left) to specify whether the DM-NAX-AMP-X300 can communicate with the XiO Cloud® platform.

Device Modes

Use the **Device Modes** section to configure the **Application Mode** and **Standby Mode**.

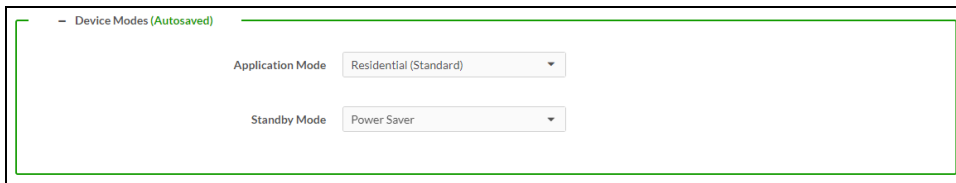

- **Application Mode:** The Application Mode determines which options and controls are available.
 - Select **Residential (Standard)** or **Commercial (Advanced)**. A **Reboot** confirmation message box appears.

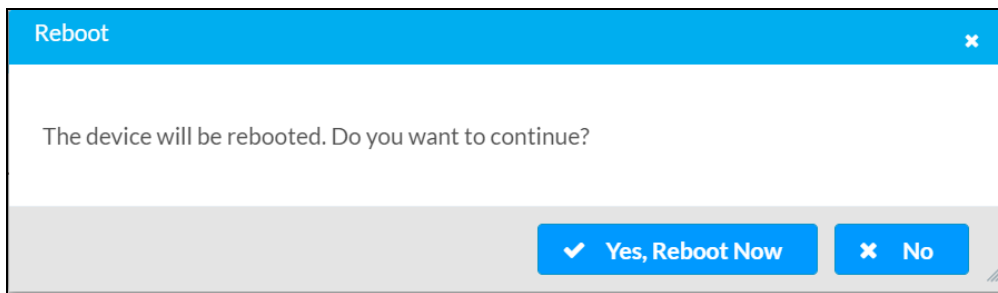

- Select **Yes, Reboot Now** to reboot the device into the selected mode. The **Reboot** message box appears.
 - Wait for the device reboot to complete before attempting to reconnect to the device.
- **Standby Mode:** Select the DM-NAX-AMP-X300's standby behavior.
 - **Always On:** The device's amplifier remains powered on at all times.
 - **Power Saver:** If no signal is detected for 25 minutes, the device enters a low power state by turning off the amplifier board. Upon detecting an audio signal, the amplifier will be turned back on.

Commissioning

The **Commissioning** section provides a quick way to automatically assign multicast addresses to all of the device's internal audio-over-IP stream transmitters.

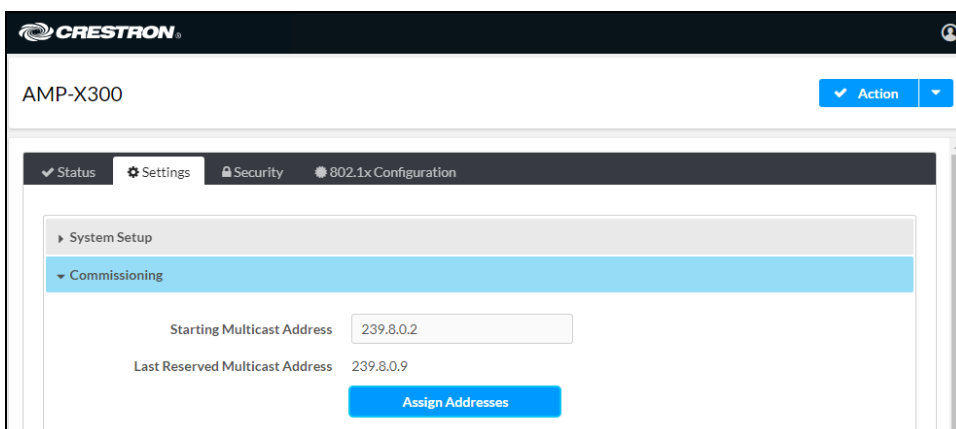

Select **Assign Addresses** to give each DM NAX transmitter in the DM-NAX-AMP-X300 a unique multicast address beginning with the specified **Starting Multicast Address**. The valid range for **Starting Multicast Address** is 239.8.0.0 to 239.127.255.255.

NOTE: This will begin transmitting multicast traffic on your network. Refer to [Audio-over-IP Network Design on page 632](#) for details on proper audio-over-IP network management.

Zones

The **Zones** section contains the **Volume** and **Mute** settings for all zone outputs of the device, as well as a **Configure** option for more advanced settings within each zone.

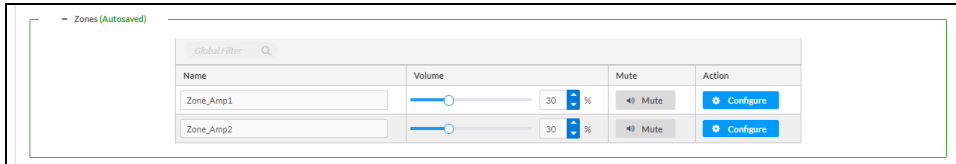

Give each zone a friendly name using the **Name** column of the **Zones** table. If the device is paired with a control system, these names may be overwritten by the control system's program.

To configure the zone volume, do one of the following:

- Move the **Volume** slider to the right to increase or to the left to decrease the zone volume.
- Use the **%** arrows to increase or decrease the zone volume. Values range from 0 to 100%, adjustable in increments of 1%.
- Manually enter a value in the **Volume** field.

To mute all audio output from a zone, select its respective **Mute**. To unmute the zone, select **Muted**.

Zone Settings

To configure zone settings, select **Configure** ( **Configure**). The **Edit Zone** window appears.

Zone

Select **Zone** to access the settings for **Tone**, **Balance**, and **Delay**.

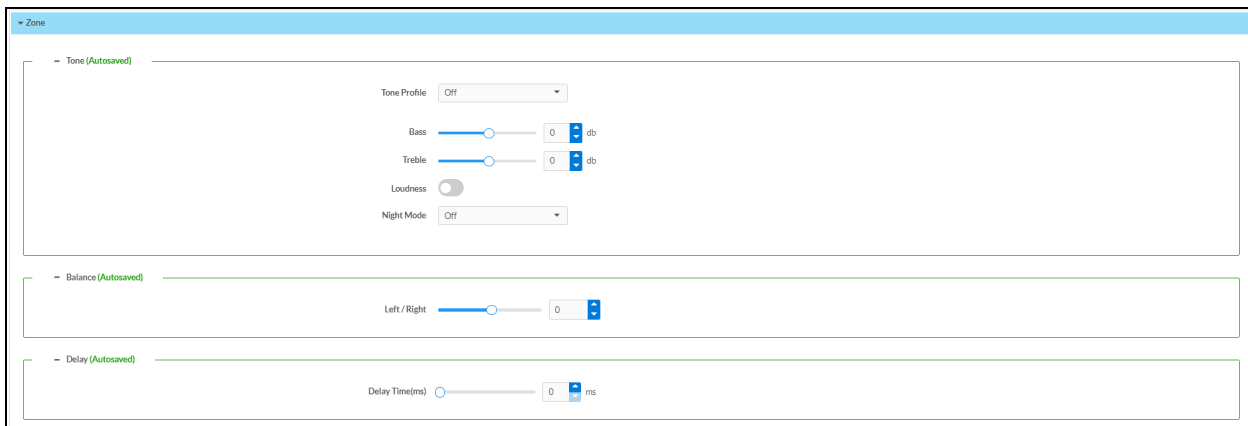

Tone



The **Tone** section provides adjustments for the **Tone Profile**, **Bass**, **Treble**, **Loudness**, and **Night Mode** settings of the zone output.

NOTE: The Tone Profile, Bass, Treble, and Loudness settings in the Tone section are all applied separately from the Equalizer Settings for the zone. This means that any adjustments made in the Tone section will stack with those made in the Equalizer Settings section.

1. To select a tone profile preset for the zone, select an option from the **Tone Profile** drop-down menu. The available options are **Off**, **Classical**, **Jazz**, **Pop**, **Rock**, and **Spoken Word**. By default, **Off** is selected.
2. **Bass:** To adjust the bass, do one of the following:
 - Move the **Bass** slider to the right to increase or to the left to decrease the bass.
 - Use the **db** arrows to increase or decrease the bass level. Values range from -12 dB to 12 dB, adjustable in increments of 1 dB.
 - Manually enter a value in the **Bass** field.
3. **Treble:** To adjust the treble, do one of the following:
 - Move the **Treble** slider to the right to increase or to the left to decrease the treble.
 - Use the **db** arrows to increase or decrease the treble level. Values range from -12 dB to 12 dB, adjustable in increments of 1 dB.
 - Manually enter a value in the **Treble** field.
4. To enable the loudness setting on the zone output, slide the **Loudness** switch to the right. To disable loudness, slide the **Loudness** switch to the left.
5. The **Night Mode** feature applies subtle processing to restrict the dynamic range of the zone audio, to allow for lower listening levels at night or in rooms where higher listening levels would be disruptive. To select a dynamics processing level, select an option from the **Night Mode** drop-down menu. The available options are **Off**, **Low**, **Medium**, and **High**. By default, **Off** is selected.

Balance



To adjust the left/right balance of the stereo output signal, do one of the following:

- Move the **Balance** slider to the right to shift the stereo balance to the right channel or to the left to shift the balance to the left.
- Use the arrows to adjust the balance left or right. The up arrow shifts the balance to the right while the down arrow shifts the balance to the left.
- Manually enter a value in the **Balance** field. Values range from -50 to 50, adjustable in increments of 1. Positive values shift the balance to the right while negative values shift the balance to the left.

Delay

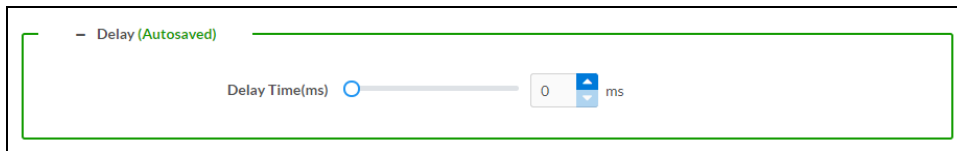

To set the delay, do one of the following:

- Move the **Delay Time(ms)** slider to the right to increase or to the left to decrease the delay time.
- Use the **ms** arrows to increase or decrease the delay. Values range from 0 ms to 250 ms, adjustable in increments of 1 ms.
- Manually enter a value in the **Delay Time(ms)** field.

Output

Select **Output** to access the settings for **Minimum/Maximum Volume, Stereo/Mono, Signal, Bussing Volume Offset, Speaker Configuration, Speaker/Faults, Line Out, Signal Generator, and Equalizer Settings.**

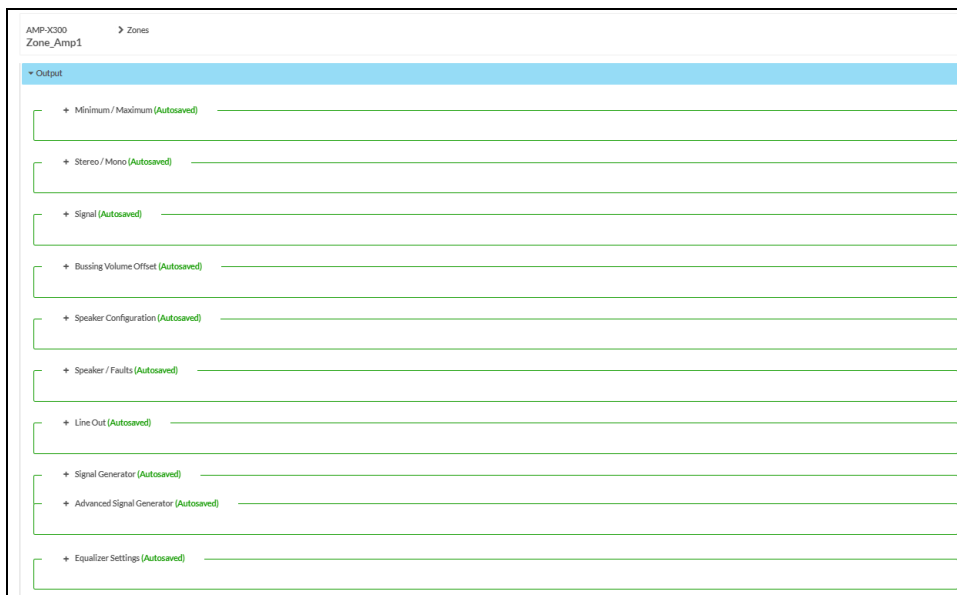

Minimum/Maximum Volume

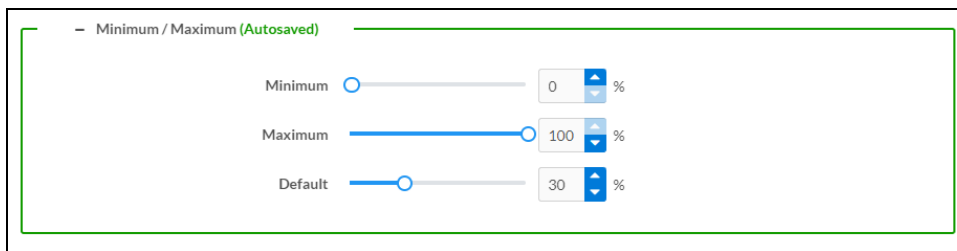

1. To set the minimum volume of the zone, do one of the following:
 - Move the **Minimum** slider to the right to increase or to the left to decrease the minimum volume.
 - Use the **%** arrows to increase or decrease the minimum volume. Values range from 0 to 50%, adjustable in increments of 1%.
 - Manually enter a value in the **Minimum** field.
2. To set the maximum volume of the zone, do one of the following:
 - Move the **Maximum** slider to the right to increase or to the left to decrease the maximum volume.
 - Use the **%** arrows to increase or decrease the maximum volume. Values range from 70 to 100%, adjustable in increments of 1%.
 - Manually enter a value in the **Maximum** field.

NOTE: When a **Minimum** and **Maximum** volume are set, the 1-100% range represented by the **Zone** and **Default** volume controls are scaled to the range set. For example, if a **Minimum** of 10% and a **Maximum** of 80% are set for a zone, the 1-100% range of the **Zone** volume control is scaled to the 10%-80% range set as the **Minimum** and **Maximum**.

3. To set the default volume of the zone, do one of the following:
- Move the **Default** slider to the right to increase or to the left to decrease the default volume.
 - Use the **%** arrows to increase or decrease the default volume. Values range from 0 to 50%, adjustable in increments of 1%.
 - Manually enter a value in the **Default** field.

NOTE: The **Default** volume is applied as the **Zone** volume any time the zone receives a source route and no source was previously routed to that zone.

Stereo/Mono

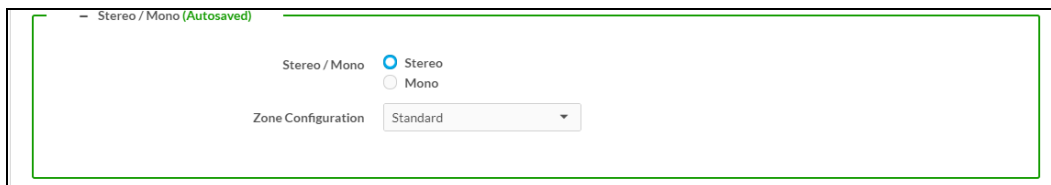

1. Select either **Stereo** or **Mono**.
2. Select the zone configuration from the **Zone Configuration** drop-down menu. The available values are **Standard**, **Bridged**, **Bridged Sub 2.1**, and **Bridged Mono**. See the diagrams below for the output signal flow applied in each configuration.

NOTE: The **Stereo/Mono** field is disabled for the Bridge Mono, and Bridged Sub 2.1 zone configurations.

Stereo - Standard

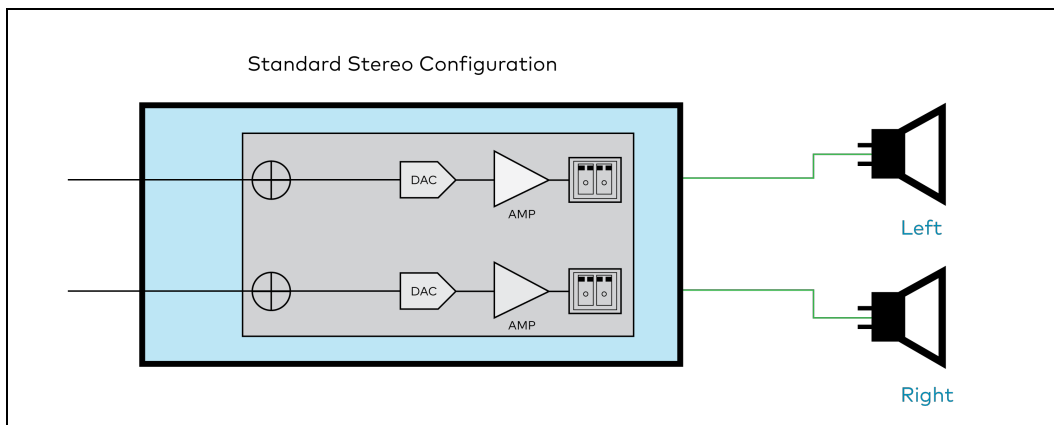

Stereo - Bridged

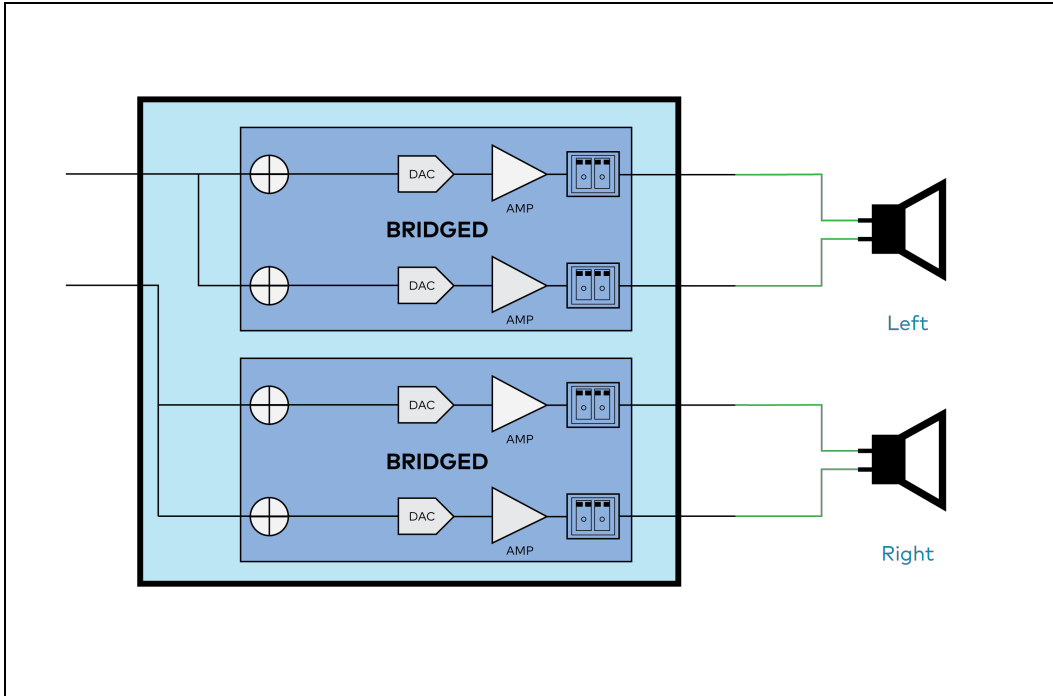

Mono - Standard

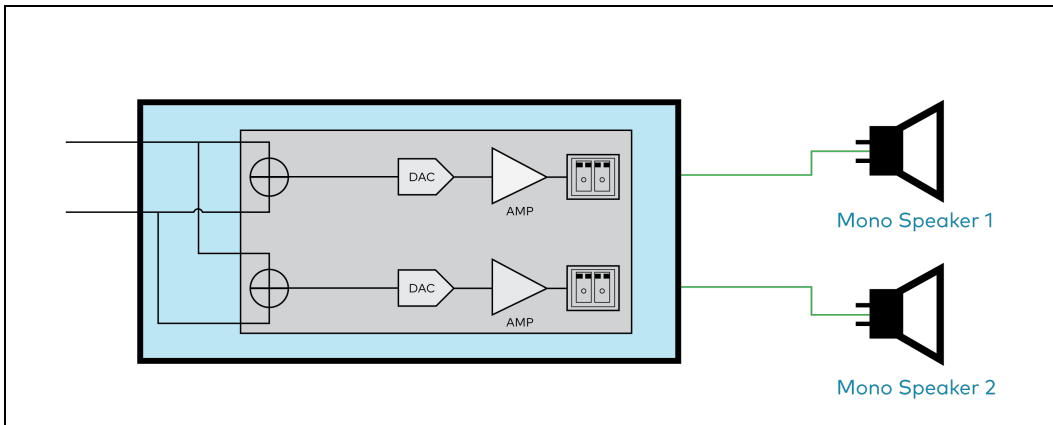

Mono - Bridged

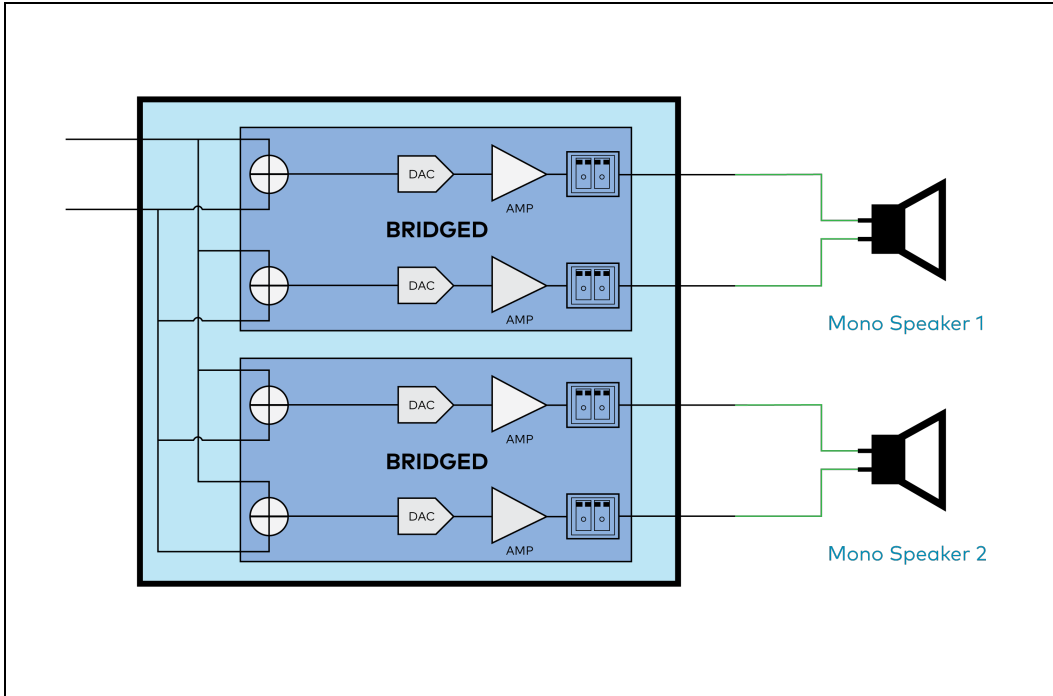

Bridged Sub 2.1

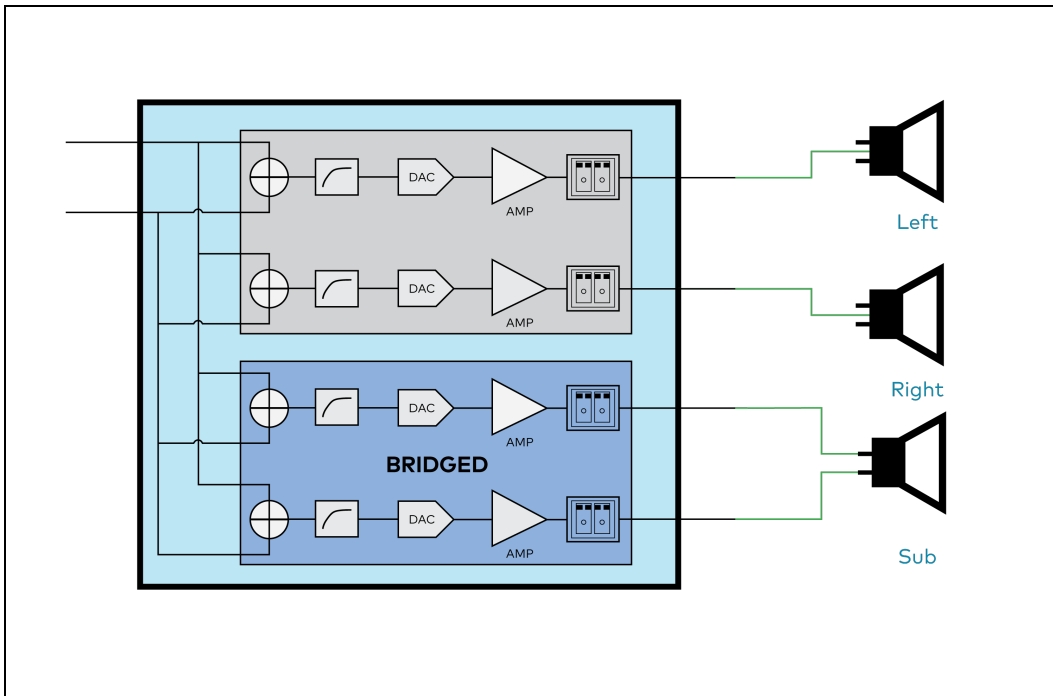

Bridged Mono

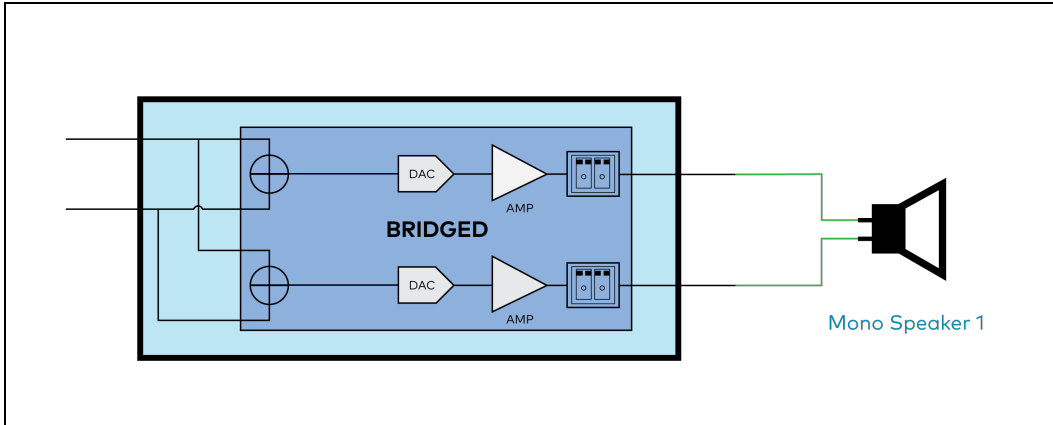

Signal

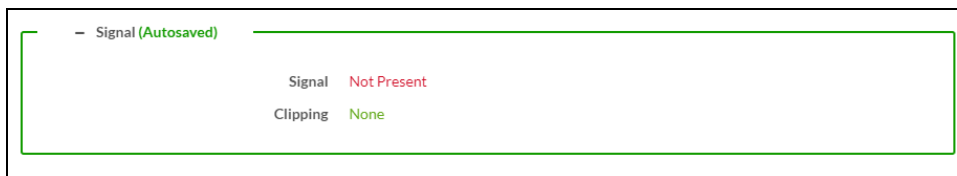

The **Signal** section is a read-only field that displays the **Signal** and **Clipping** status of the zone output.

- If an output signal is present but not clipping, **Signal** will display **Present** in green and **Clipping** will display **None** in green.
- If an output signal is present and clipping, **Signal** will display **Present** in green and **Clipping** will display **Present** in red.
- If no output signal is detected, **Signal** will display **Not Present** in red and **Clipping** will display **None** in green.

Bussing Volume Offset



Bussing Volume Offset is an additional level compensation applied to the zone relative to any other zones it is grouped with via the **Bussing** feature.

To set the bussing volume offset, do one of the following:

- Move the **Bussing Volume Offset** slider to the right to increase or to the left to decrease the offset.
- Use the **db** arrows to increase or decrease the offset. Values range from -12 dB to 12 dB, adjustable in increments of 1 dB.
- Manually enter a value in the **Bussing Volume Offset** field.

Speaker Configuration

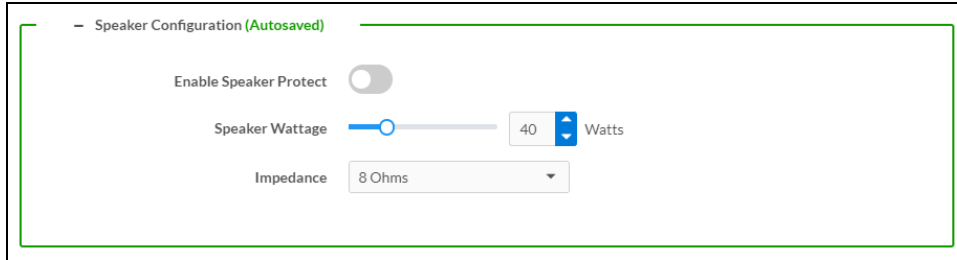

1. Set the **Enable Speaker Protect** toggle to the right position to enable speaker protection for the zone output. Set the toggle to the left position to disable speaker protection. By default, **Enable Speaker Protect** is set to the left position.
2. To set the maximum output wattage, do one of the following:
 - Move the **Speaker Wattage** slider to the right to increase or to the left to decrease the maximum peak amplifier wattage that can be output to the speaker.
 - Use the **Watts** arrows to increase or decrease the maximum peak amplifier wattage that can be output to the speaker. Values range from 5 W to 150 W, adjustable in increments of 1 W.
 - Manually enter a value in the **Speaker Wattage** field.
3. Select the impedance of the speaker on a selected zone from the **Impedance** drop-down menu. Values are **4 Ohms**, **8 Ohms**, and **Bridged**.

Speaker/Faults

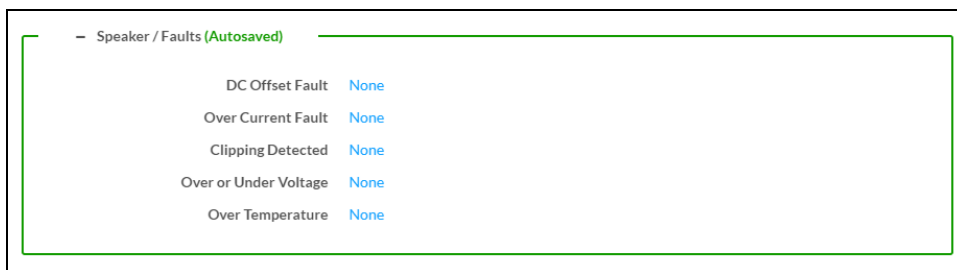

The Speaker/Faults section is a read-only field that displays the status of the **DC Offset Fault**, **Over Current Fault**, **Clipping Detected**, **Over or Under Voltage**, and **Over Temperature** detectors for the zone output. If clipping or a given fault type is detected, then its corresponding readout displays **Fault Detected** in red. Otherwise, it displays **None** in blue.

Line Out

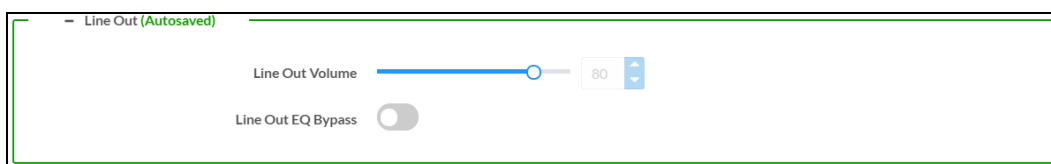

Line Out Volume controls the volume level of the corresponding line-level output on the DM NAX device. The Line Out Volume is only applied when **Line Out EQ Bypass** is enabled.

- To set the line out volume, do one of the following:
 - Move the **Line Out Volume** slider to the right to increase or to the left to decrease the line out volume.
 - Use the arrows to increase or decrease the line out volume. Values range from 0 to 100, adjustable in increments of 1. This range in dB is -80 dB to 20 dB.
 - Manually enter a value in the **Line Out Volume** field.
- Set the **Line Out EQ Bypass** toggle to the right position to have the line-level output signal bypass the zone's equalizer settings. Set the toggle to the left position to have the line-level output signal pass through the zone's equalizer. By default, **Line Out EQ Bypass** is disabled.

NOTE: When the **Line Out EQ Bypass** setting is disabled, the line-level output's level will mirror the speaker output's **Zone** volume control. This allows for a variable signal level in applications where the line-level output is connected to an uncontrolled device such as powered speakers. If the **Line Out EQ Bypass** setting is enabled, the **Line Out Volume** slider can be used to set a fixed level for the line-level output. This level will not be affected by the speaker output **Zone** volume controls, making this configuration better suited to applications where the line output is connected to a controlled amplifier with its own level adjustment.

Signal Generator

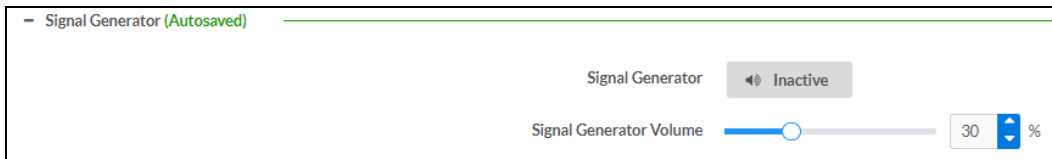

The DM-NAX-AMP-X300 has a built-in signal generator that allows an integrator to send an audio signal to any number of selected zones to test output functionality.

- To route the signal generator to the zone output, select **Signal Generator** so that it displays **Active** and is highlighted in blue. To unroute the signal generator on the zone output, select **Signal Generator** so that it displays **Inactive** and is highlighted in grey. By default, the signal generator is not routed to the zone output.

NOTES:

- There is only one signal generator built-in to the DM NAX device. Each zone has its own button to enable or disable the signal generator from passing signal to that output. Setting the signal generator to **Inactive** on a given zone output only breaks the route for that output and does not stop it from playing back in other zones.
- The **Signal Generator Volume** control is a local control that does not affect the signal generator's volume on other zone outputs. Only the settings under **Advanced Signal Generator** are applied universally to all zones of the DM NAX device.

2. To adjust the signal generator's volume, do one of the following:
 - Move the **Signal Generator Volume** slider right to increase or left to decrease the volume.
 - Use the arrows to increase or decrease the signal generator volume. Values range from 0 to 100, adjustable in increments of 1.
 - Manually enter a value in the **Signal Generator Volume** field.

Advanced Signal Generator

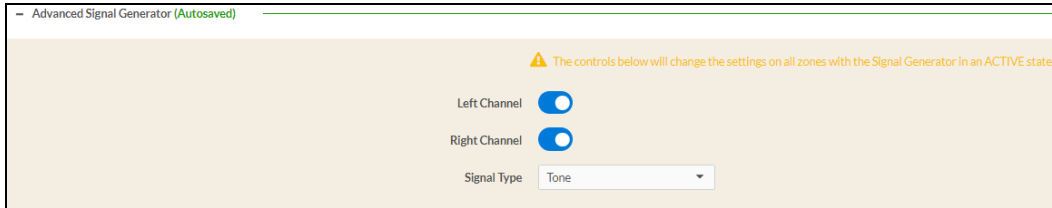







The advanced signal generator settings control the built-in signal generator directly, and are applied universally to all output zones of the DM NAX device. The signal type for the generator can be set, and the left and right channels of the test signal can be individually enabled or disabled.

1. Set the **Left Channel** toggle to the right position to enable the left channel of the signal. Set the toggle to the left position to disable the left channel. By default, **Left Channel** is enabled.
2. Set the **Right Channel** toggle to the right position to enable the right channel of the signal. Set the toggle to the left position to disable the right channel. By default, **Right Channel** is enabled.
3. Select an audio test signal type from the **Signal Type** drop-down menu. The available signal types are:
 - **Tone**: Generates a 1 kHz sine wave tone.
 - **Pink Noise**: Generates pink noise.
 - **White Noise**: Generates white noise.

Equalizer Settings

Equalizer Settings (Autosaved)

Speaker EQ Enabled

Band	Band01	Band02	Band03	Band04	Band05	Band06
Gain	 0	 0	 0	 0	 0	 0
Type	EQ	EQ	EQ	EQ	EQ	EQ
Frequency	32	64	125	250	500	1000
Bandwidth	0.33	0.33	0.33	0.33	0.33	0.33
Bypass	<input type="checkbox"/>	<input type="checkbox"/>	<input type="checkbox"/>	<input type="checkbox"/>	<input type="checkbox"/>	<input type="checkbox"/>
Actions	Reset	Reset	Reset	Reset	Reset	Reset

Each zone output of the DM-NAX-AMP-X300 has a dedicated ten-band equalizer that can be fully customized to tune the zone output signal to the needs of an install. Each band can have a discrete gain, filter type, center frequency, and bandwidth set, and can also be bypassed. The equalizer itself can also be bypassed using the **Speaker EQ Enabled** toggle.

1. Set the **Speaker EQ Enabled** toggle to the right position to enable the equalizer. Set the toggle to the left position to bypass the equalizer.

NOTE: When **Speaker EQ Enabled** is disabled, all equalizer bands are bypassed. This is a quick way to perform A/B testing of the entire EQ curve.

2. With the **Speaker EQ Enabled** toggle in the right position, configure the equalizer bands.
 - a. To set a band's gain, do one of the following:
 - Move the **Gain** slider up to increase or down to decrease the gain.
 - Use the arrows to increase or decrease the gain. Values range from -40 dB to 20 dB, adjustable in increments of 0.1 dB.
 - Manually enter a value in the **Gain** field.

- b. Select a filter type from the **Type** drop-down menu. By default, all bands are set to the **EQ** filter type. Some filter types will disable other settings in their respective band while enabled. For example, selecting the **LowPass** filter type for a band will disable that band's **Gain** and **Bandwidth** settings, since the **LowPass** filter applies a fixed roll-off slope at a set frequency. The available filter types are:
- **EQ:** a fully parametric filter that can boost or cut a range of frequencies.
 - **Notch:** a parametric filter designed to more precisely cut a frequency or range of frequencies. A notch filter can achieve a narrower bandwidth than the standard **EQ** parametric filter type.
 - **TrebleShelf:** a filter that boosts or cuts all frequencies above a set frequency by a set gain.
 - **BassShelf:** a filter that boosts or cuts all frequencies below a set frequency by a set gain.
 - **LowPass:** a filter that fully cuts all frequencies above a set frequency using a fixed roll-off slope of -12 dB per octave.
 - **HighPass:** a filter that fully cuts all frequencies below a set frequency using a fixed roll-off slope of -12 dB per octave.
- c. Set a center frequency for the equalizer band to tune a specific portion of the audible frequency spectrum. To set the center frequency, do one of the following:
- Use the arrows to increase or decrease the frequency. Values range from 20 Hz to 20 kHz, adjustable in increments of 1 Hz. Each band has a default center frequency that will be applied if **Reset** at the bottom of the band is selected.
 - Manually enter a value in the **Frequency** field.
- d. Set a bandwidth to determine how wide of a frequency range is effected by the equalizer band. To set the bandwidth, do one of the following:
- Use the arrows to increase or decrease the bandwidth. Values range from 0.1 octaves to 4.0 octaves, adjustable in increments of 0.1 octave.
 - Manually enter a value in the **Bandwidth** field.
- e. The individual Bypass controls allow you to bypass a single band of equalization at a time for more granular A/B testing of a single filter. Set a band's **Bypass** toggle to the right position to bypass that band. Set the toggle to the left position to disable the bypass. By default, **Bypass** is disabled.
- f. Each equalizer band has a **Reset** that will reapply the default settings for that band.

Select **Done** to return to the **Settings** tab of the web user interface.

Bussing



The bussing feature on DM NAX devices allows an integrator to assign any number of selected zones to a fixed group of zones (bus). Zones in a bus track the other zones' volume and routing. For example,

when the source or volume for one zone in the bus is adjusted, all other zones in that bus receive the same adjustment. You can create a single output bus on the DM-NAX-AMP-X300.

Configure Bussing

1. If needed, enter a friendly name for each bus in its **Name** field.
2. Select any number of zones from the **Included Zones** drop-down menu.

Inputs

The **Inputs** section is used to configure the **Name**, **Compensation**, and **Mute** attributes of the available analog, digital, and media streaming inputs on the DM-NAX-AMP-X300.

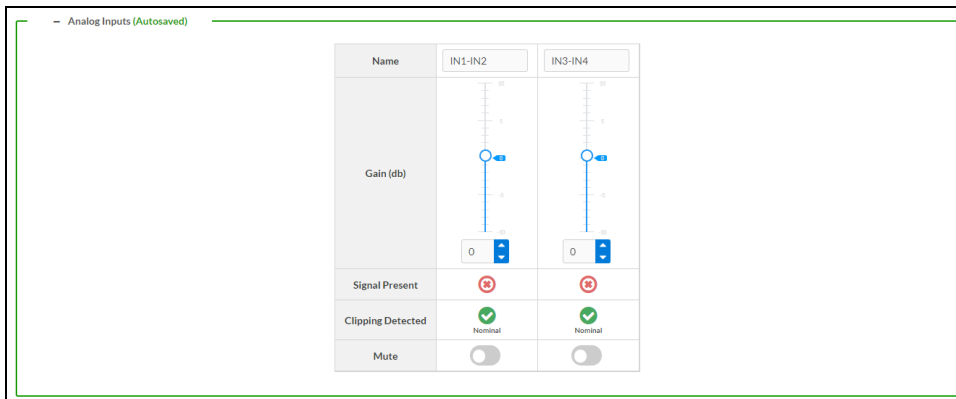

1. If needed, enter a friendly name for each input in its **Name** field.
2. To set a level compensation adjustment for a given input, do one of the following:
 - Move the **Compensation** slider up to increase or down to decrease the compensation. Compensation increases or decreases the level of the incoming audio signal on any of the physical inputs on the device's rear panel.
 - Use the **db** arrows to increase or decrease the compensation. Values range from -10 dB to 10 dB, adjustable in increments of 1 dB.
 - Manually enter a value in the **Compensation** field.
3. To mute the signal from the corresponding input, select **Mute**. To disable the mute, select **Muted**. By default, **Mute** is disabled.

Monitor the device's input signals using the indicators in the **Signal Present** and **Clipping Detected** rows:

- **Signal Presence** indicates whether or not a signal is detected in that zone.
- **Clipping Detected** indicates if the signal is **Clipping** or **Nominal** (non-clipping).

NAX Streams

Each local input of the DM-NAX-AMP-X300 can be made available as a DM NAX audio-over-IP stream.

The DM-NAX-AMP-X300 also supports parallel DM NAX streams for each zone output, enabling an additional transmit stream per output to mirror all routes and DSP settings of its respective zone. These parallel streams enable control of the audio signal to third-party uncontrolled AES67 devices receiving audio from the DM-NAX-AMP-X300.

NOTES:

- Under the **Transmitters** section (see [Configure Transmitters](#)), the last two listed transmitters are dedicated to parallel zone outputs.
- To configure the DSP settings, see [Zone Settings](#).

Select **NAX Streams** to display the following information.

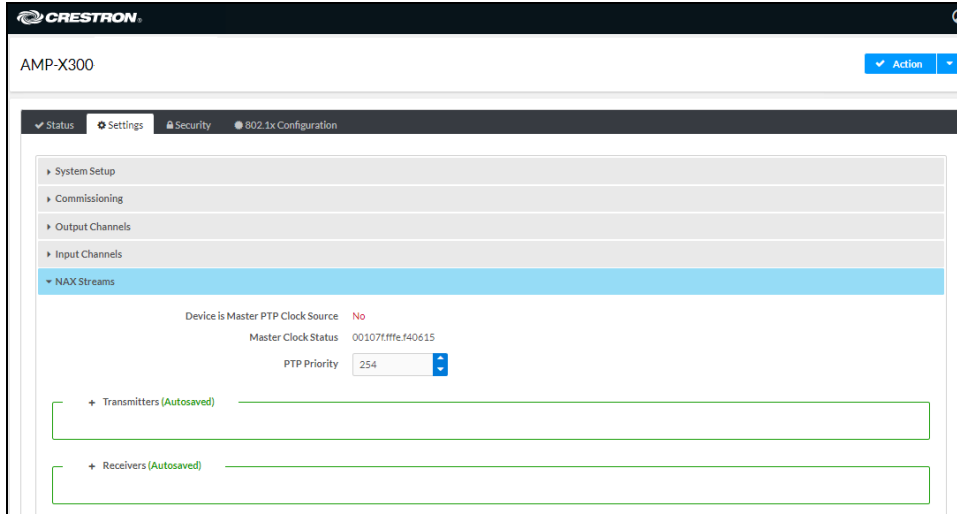

- **Device is Leader PTP Clock Source** indicates whether the device is the leader for PTP on the network. **Yes** will be displayed in green when the local DM-NAX-AMP-X300 is the PTP leader clock and **No** will be displayed in red when another PTP clock on the network is operating as the leader clock.
- **Leader Clock Status** displays the Leader Clock ID of the device on the network that acts as the Leader Clock.
- **PTP Priority**: This sets the priority of the local DM NAX device's PTP clock relative to other clocks on the network. The default setting is 254 (one increment higher than the lowest possible value) so that the DM-NAX-AMP-X300 will only operate as the leader clock if no other PTP leader is present on the network. Valid values range from 1 to 255.

Configure Transmitters

Audio Source	Stream	Nax Stream Address	Nax Stream Name	Status	Actions
IN1-IN2	Stream01	239.8.0.2	Stream01c4.42.68.18.54.47	Stream Started	▶ □ ⚙
IN3-IN4	Stream02	239.8.0.3	Stream02c4.42.68.18.54.47	Stream Started	▶ □ ⚙

To configure a DM NAX transmit stream:





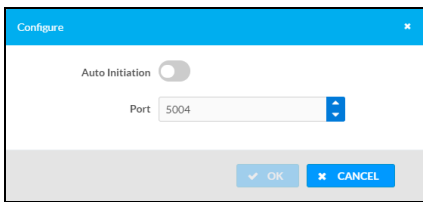

1. Enter a valid multicast address in the **NAX Stream Address** field.
2. Enter a name in the **NAX Stream Name** field by which the stream can be identified. This stream name is associated with the DM NAX stream's multicast address by other DM NAX or AES67 devices, like a device hostname that resolves to a given IP address.

- Status** indicates whether a stream is transmitting or not. When the stream has started or stopped, the **Status** column will update accordingly.
- Select the configure icon  in the **Actions** column. The **Configure** dialog appears:



- Set the **Auto Initiation** toggle to the right position to enable auto initiation. Set the toggle to the left position to disable auto initiation.
 - If **Auto Initiation** is enabled for a given stream, the stream will begin transmitting automatically and will be available as a multicast stream on your network at the specified multicast address.
 - If **Auto Initiation** is disabled for the input, the stream will not begin transmitting until it is manually initiated.
- To set the port number, do one of the following:
 - Use the arrows to increase or decrease the port number by increments of 1.
 - Manually enter a port number in the **Port** field. The default port number for DM NAX streams is 5004.
- Select **OK** to save or select **Cancel** to cancel the changes.

Configure Receivers

Zone Name	Stream	Current Stream Address	Requested Stream Address	Status	Actions
Zone_Amp1	Stream01	0.0.0.0	0.0.0.0	Stream Stopped	  
Zone_Amp2	Stream02	0.0.0.0	0.0.0.0	Stream Stopped	  

- Enter the multicast address of a transmitting stream in the **Requested Stream Address** field to subscribe the receiver to the stream.
- Select the configure icon  in the **Actions** column. The **Configure** dialog appears:

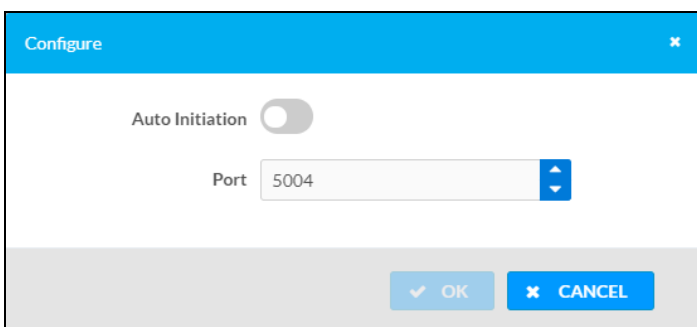

3. Set the **Auto Initiation** toggle to the right position to enable auto initiation. Set the toggle to the left position to disable auto initiation.
 - If **Auto Initiation** is enabled, the stream will begin automatically when the receiver subscribes to the transmitter.
 - If **Auto Initiation** is disabled, the stream will not begin until it is manually initiated.
4. To set the port number, do one of the following:
 - Use the arrows to increase or decrease the port number by increments of 1.
 - Manually enter a port number in the **Port** field. The default port number is 5004.
5. Select **OK** to save or select **Cancel** to cancel the changes.

Routing

The **Routing** section is used to route a local input or AES67 stream to a Zone on the DM-NAX-AMP-X300.

NOTE: To receive an AES67 stream from Dante devices, see [OLH 1001151](#).

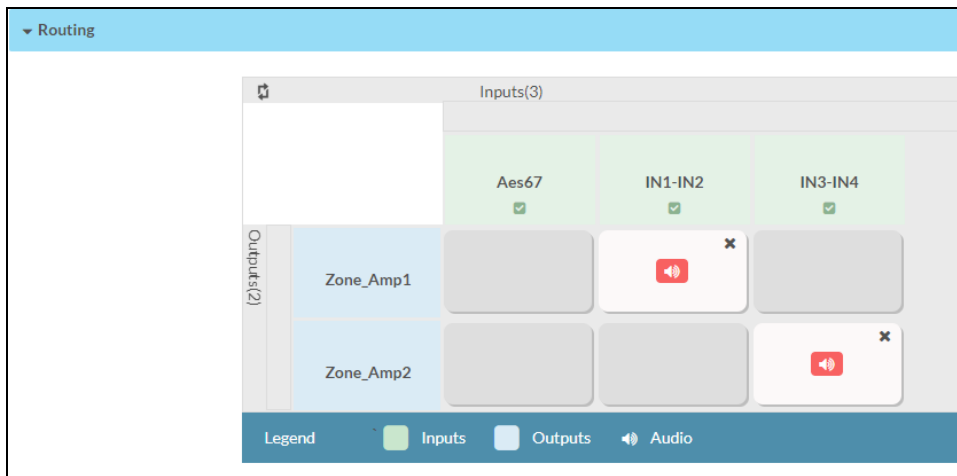

- To route an input to a zone, select the box in the routing matrix where the zone's row overlaps the corresponding input's column. Once a route is made, appears.
- To break a given route select or .
- To route a single input to all zones, select the icon under the input's name.

Use the arrows (or) at the top of the matrix to change pages to view all available inputs.

Port Selection

The **Port Selection** feature allows the device's internal network traffic to be managed and segregated based on traffic type. Internal VLANs are used to segment device management and streaming service traffic to a separate physical device Ethernet port than audio-over-IP streaming traffic. With **Port Selection** enabled on all DM NAX devices on a network, DM NAX and AES67 network traffic can be physically separated from the control network onto a dedicated audio network.

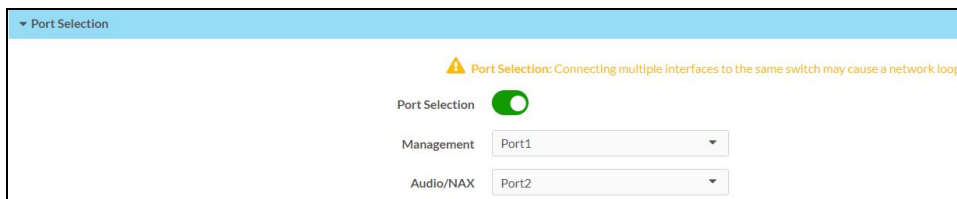

To configure **Port Selection**:

1. Set the **Port Selection** toggle to the right position to enable **Port Selection**. Set the toggle to the left position to disable **Port Selection**. By default, **Port Selection** is disabled.

NOTE: **Port1** and **Port2** correspond to the Ethernet adapters labeled **1** and **2** on the rear panel of the DM-NAX-AMP-X300, respectively.

2. With **Port Selection** enabled:
 - a. Select an Ethernet port from the **Management** drop-down menu to designate which Ethernet port on the rear panel of the device will handle network traffic relating to device configuration and the device's connection to a control system.

NOTE: The Management port determines your connection to the web interface. Changing the port value can result in losing your connection to the device via the web interface.

- b. Select an Ethernet port from the **Audio/NAX** drop-down menu to designate which Ethernet port on the rear panel of the device will handle audio-over-IP streaming network traffic.
3. Select **Save** changes to apply the new settings.

NOTE: Making changes to **Port Selection** settings will require a reboot.

Security

Select the **Security** tab to configure security for users and groups and to allow different levels of access to the DM-NAX-AMP-X300 functions. By default, security is disabled.

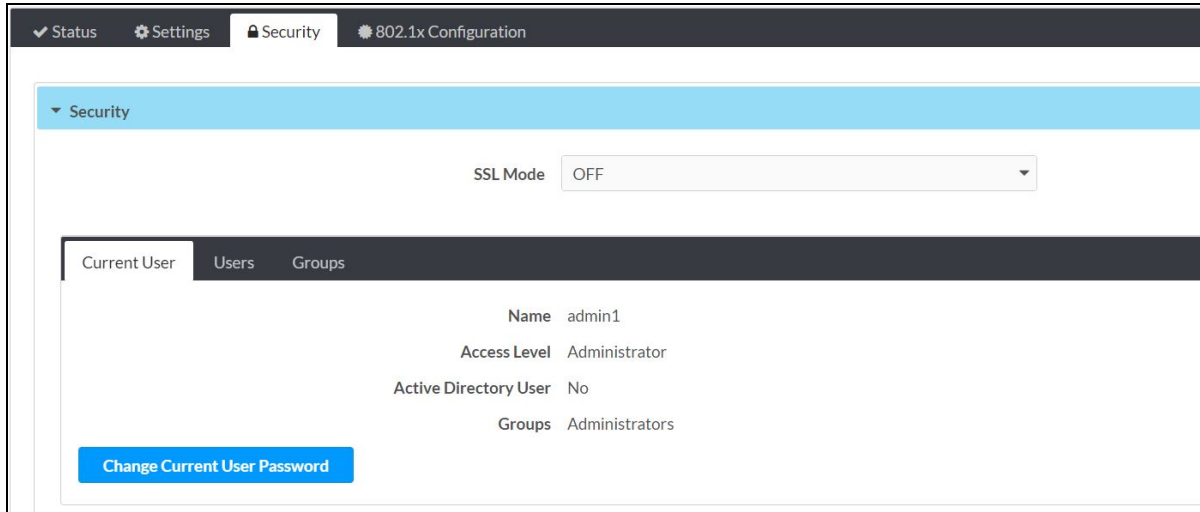

Select **Encrypt and Validate**, **Encrypt**, or **OFF** in the **SSL Mode** drop-down menu, to specify whether to use encryption. By default, SSL Mode is set to **OFF**.

Current User

Select the **Current User** tab to view read-only information or to change the password for the current user.

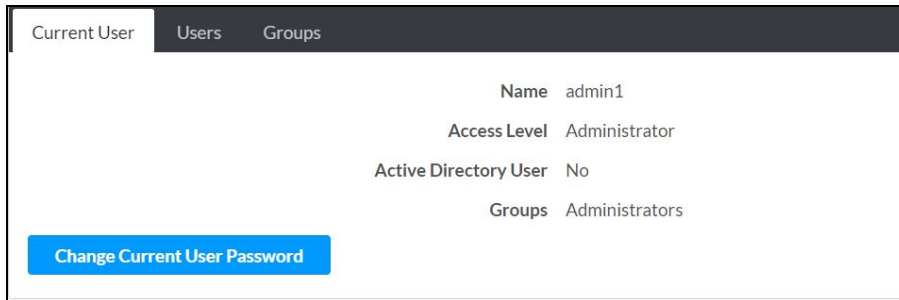

1. Select **Change Current User Password** to provide a new password for the current user.
2. In the **Change Password** dialog, enter the current password in the **Current Password** field, the new password in the **Password** field, and then re-enter the same new password in the **Confirm Password** field.

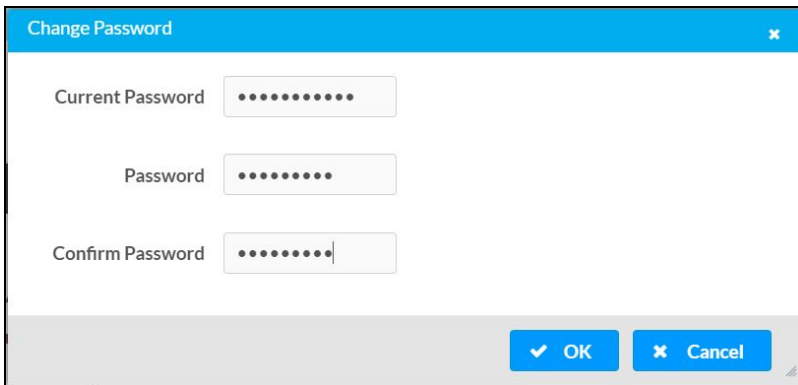

A dialog box titled "Change Password" with a close button (X) in the top right corner. It contains three password input fields: "Current Password", "Password", and "Confirm Password". Each field is filled with a series of dots representing masked characters. At the bottom of the dialog, there are two buttons: "OK" with a checkmark icon and "Cancel" with an X icon.

3. Select **OK** to save or select **Cancel** to cancel the changes.

Users

Select the **Users** tab to view and edit user settings. The **Users** tab can be used to add or remove local and Active Directory users and preview information about users.

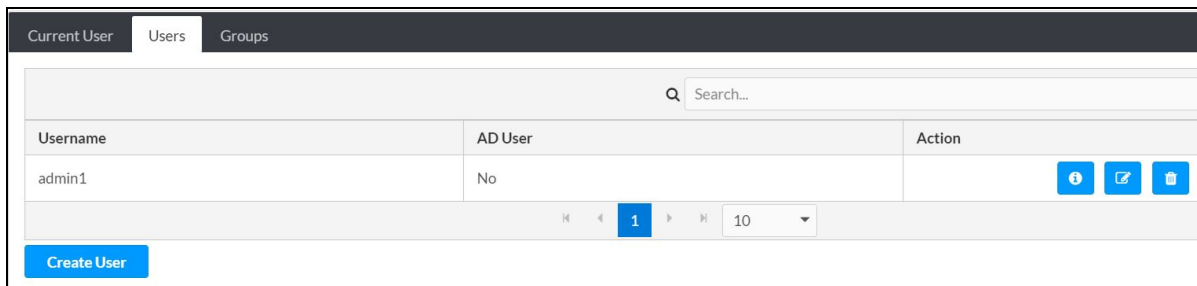

The "Users" tab interface shows a navigation bar with "Current User", "Users", and "Groups" tabs. Below the navigation bar is a search field labeled "Search...". A table displays user information with columns for "Username", "AD User", and "Action". The first row shows "admin1" as the username and "No" as the AD User status. The Action column contains three icons: a person icon, a document icon, and a trash can icon. Below the table is a pagination control showing "1" of 10 items. A "Create User" button is located at the bottom left of the interface.

Username	AD User	Action
admin1	No	[Person Icon] [Document Icon] [Trash Icon]

Use the **Search Users** field to enter search term(s) and display users that match the search criteria.

If users listed in the **Users** table span across multiple pages, navigate through the list of users by selecting a page number or by using the left or right arrows at the bottom of the **Users** pane to move forward or backward through the pages.

Each page can be set to display 5, 10, or 20 users by using the drop-down menu to the right of the navigation arrows.

Information about existing users is displayed in table format and the following details are provided for each user.

- **Username:** Displays the name of the user.
- **AD User:** Displays whether the user requires authentication using Active Directory.
Select the corresponding icon in the Actions column to view detailed user information or to delete the user.

To create a new user, select **Create User**.

Create a New Local User

1. Select **Create User** in the **Users** tab.
2. In the **Create User** dialog, enter the following:

- a. Enter a user name in the **Name** field. A valid user name can consist of alphanumeric characters (letters a-z, A-Z, numbers 0-9) and the underscore "_" character.
- b. Enter a password in the **Password** field; re-enter the same password in the **Confirm Password** field.
- c. Assign the access level by selecting one or more groups from the **Groups** drop-down list.

NOTE: Make sure that the **Active Directory User** toggle is disabled.

3. Select **OK** to save or select **Cancel** to cancel the changes.

Add an Active Directory User

Users cannot be created or removed from the Active Directory server, but access can be granted to an existing user in the Active Directory server.

To grant access to an Active Directory user, you can either add the user to a local group on the DM-NAX-AMP-X300, or add the Active Directory group(s) that they are a member of to the DM-NAX-AMP-X300.

To add an Active Directory user.

1. Select **Create User**.
2. In the **Create User** dialog, enter the following.

- a. Enter a user name in the **Name** field in the format "Domain\UserName", for example "crestronlabs.com\JohnSmith". Valid user names can contain alphanumeric characters (letters a-z, A-Z, numbers 0-9) and the underscore "_" character.
- b. Select one or more groups from the **Groups** drop-down list.

NOTE: Make sure that the **Active Directory User** toggle is set to enabled.

3. Select **OK** to save or select **Cancel** to cancel the changes.

Delete User

Select the trashcan icon  in the **Actions** column to delete the user. Select **Yes** when prompted to delete the user or **No** to cancel the deletion.

After a user is removed from a group, they lose any access rights associated with that group. Note that the user account is not deleted by the delete user operation.

View User Details

Select the information icon  in the **Actions** column to view information for the selected user. The **User Details** dialog displays the following information for the selected user.

- **Name:** Displays the name of the selected user.
- **Active Directory User:** Displays whether the user is an Active Directory user.
- **Group:** Displays group(s) the selected user is part of.

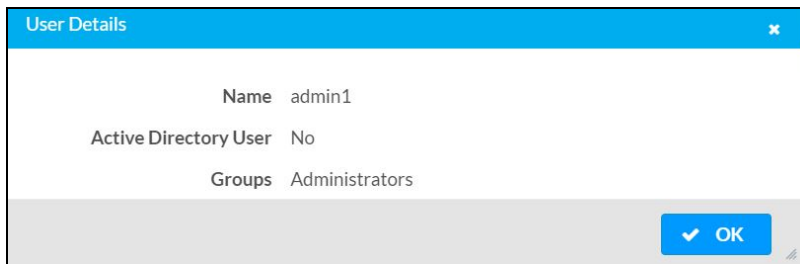

Select **OK** to close the **User Details** dialog and to return to the **Users** tab.

Update User Details

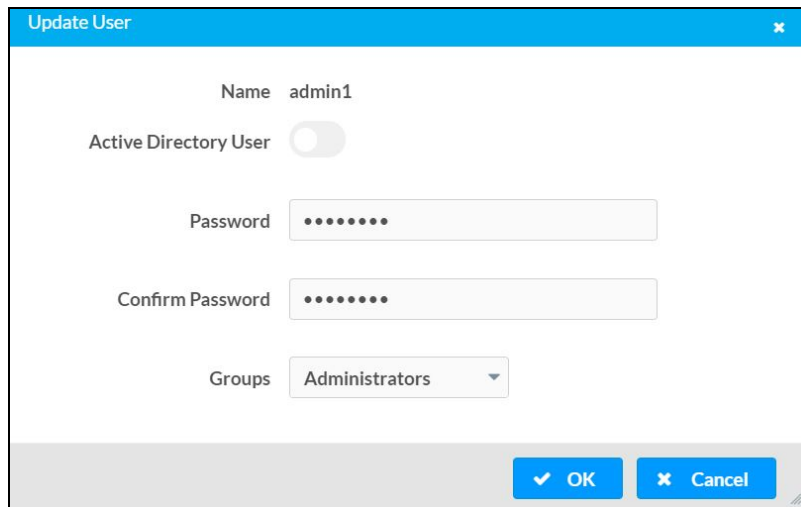

1. Select the edit icon  in the **Actions** column to update information for the selected user.
2. Enter a password in the **Password** field; re-enter the same password in the **Confirm Password** field.
3. Select one or more groups to assign the user to from the **Groups** drop-down list.
4. Select **OK** to save or select **Cancel** to cancel the changes.

The **Update User** dialog also displays the following read-only information for the selected user.









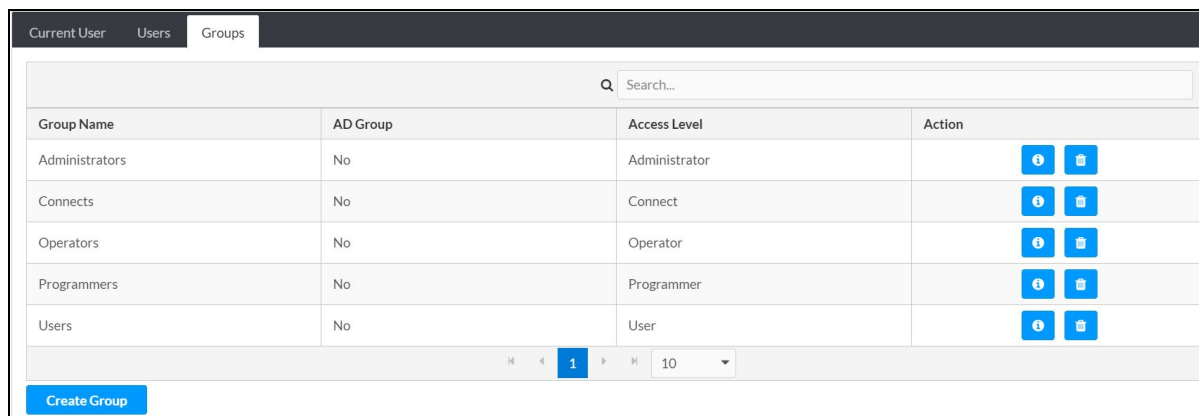

- **Name:** Displays the name of the user.
- **Active Directory User:** Displays whether the user is an Active Directory user.

Groups

Select the **Groups** tab to view and edit group settings. The **Groups** tab can be used to add local and Active Directory groups, remove local and Active Directory groups, and preview information about a group.

Use the **Search Groups** field to enter search term(s) and display groups that match the search criteria.





Group Name	AD Group	Access Level	Action
Administrators	No	Administrator	 
Connects	No	Connect	 
Operators	No	Operator	 
Programmers	No	Programmer	 
Users	No	User	 

If groups listed in the **Groups** table span across multiple pages, navigate through the groups by selecting a page number or by using the left or right arrows at the bottom of the **Groups** pane to move forward or backward through the pages.

Additionally, each page can be set to display 5, 10, or 20 groups by using the drop-down menu to the right of the navigation arrows.

Existing groups are displayed in a table and the following information is provided for each group:

- **Group Name:** Displays the name of the group.
- **AD Group:** Displays whether the group requires authentication using Active Directory.
- **Access Level:** Displays the predefined access level assigned to the group (Administrator, Programmer, Operator, User, or Connect).

Select the corresponding icon in the **Actions** column to view detailed group information  or to delete  selected group.

Select **Create Group** in the **Groups** tab to create new group.

Create Local Group

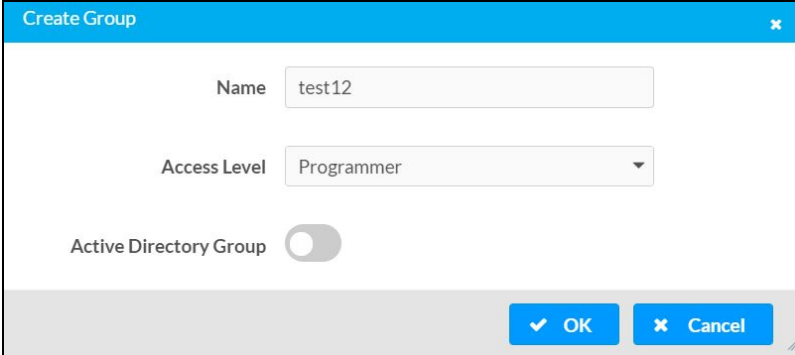

1. Select **Create Group**.
2. In the **Create Group** dialog, enter the following:
 - a. Enter the group name in the **Name** field.
 - b. Assign the group access level by selecting a predefined access level (Administrator, Connect, Operator, Programmer, User) from the **Access Level** drop-down list.

NOTE: Make sure that the **Active Directory Group** toggle is disabled.

3. Select **OK** to save. Select **Cancel** to cancel the changes.

Add Active Directory Group

A group cannot be created or removed from the Active Directory server, but access can be granted to an existing group in Active Directory.

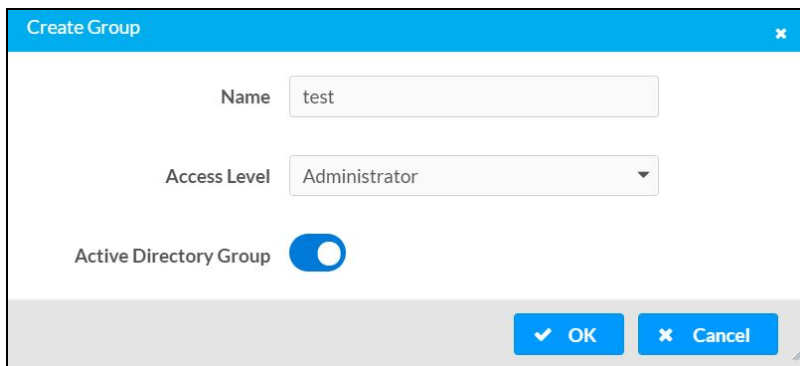

Once the group is added, all members of that group will have access to the DM-NAX-AMP-X300.

1. Select **Create Group**.
2. In the **Create Group** dialog enter the following:
 - a. Enter the group name in the **Name** field, for example "Engineering Group". Note that group names are case sensitive; a space is a valid character that can be used in group names.
3. Assign the group access level by selecting a predefined access level (Administrator, Connect, Operator, Programmer, User) from the **Access Level** drop-down list.

NOTE: Make sure that the **Active Directory Group** toggle is enabled.

4. Select **OK** to save. Select **Cancel** to cancel the changes.

Delete a Group

Select the trashcan icon  in the **Actions** column to delete a group. Select **Yes** when prompted to delete the group or **No** to cancel the deletion.

When a group is deleted, users in the group are not removed from the device or Active Directory server. However, because a user's access level is inherited from a group(s), users within the deleted group will lose access rights associated with the group.

View Group Details

Select the information icon  in the **Actions** column to view information for the selected group. The **Group Details** dialog lists the following information for the selected group.

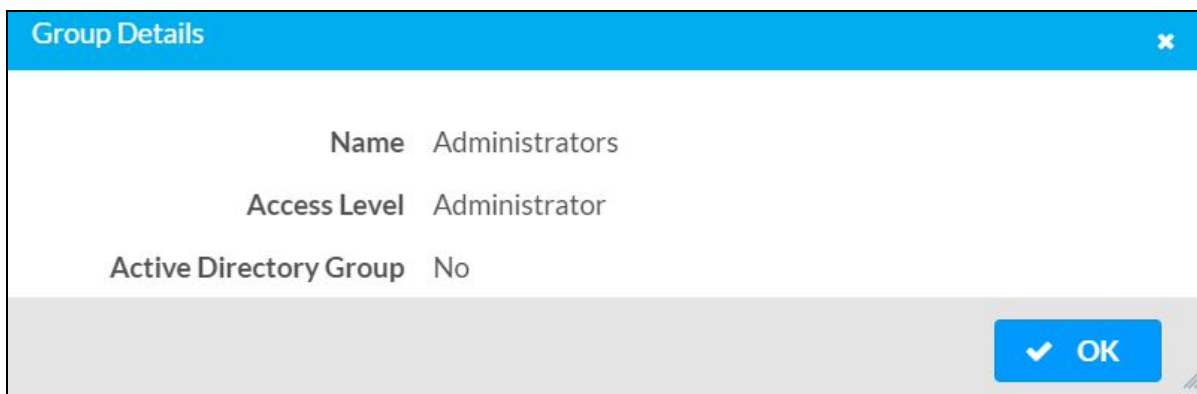

- **Name:** Displays the name of the group.
- **Access Level:** Displays the access level of the group and its users.
- **Active Directory Group:** Displays whether the group is an Active Directory group.

Select **OK** to close the **Group Details** dialog and to return to the **Groups** tab.

802.1x Configuration

The DM-NAX-AMP-X300 has built-in support for the 802.1X standard (an IEEE network standard designed to enhance the security of wireless and Ethernet LANs. The standard relies on the exchange of messages between the device and the network's host, or authentication server), allowing communication with the authentication server and access to protected corporate networks.

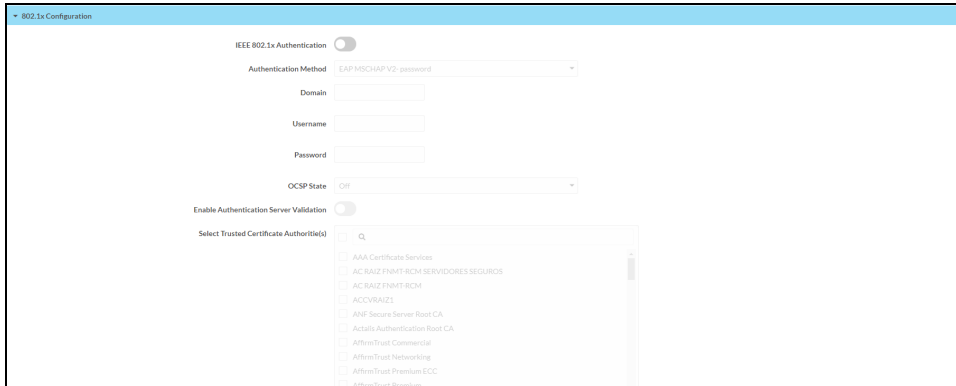

Configure DM-NAX-AMP-X300 for 802.1X Authentication

1. Set the **IEEE 802.1X Authentication** toggle to enabled. This will enable all options on the 802.1X dialog.
2. Select the **Authentication method: EAP-TLS Certificate** or **EAP-MSCHAP V2 Password** according to the network administrator's requirement.
3. Do either one of the following:
 - Select **EAP-TLS Certificate**: Select **Action/Manage Certificates** to upload the required machine certificate. The machine certificate is an encrypted file that will be supplied by the network administrator, along with the certificate password.
 - Select **EAP-MSCHAP V2 Password**: Enter the username and password supplied by the network administrator into the **Username** and **Password** fields. This method does not require the use of a machine certificate, only the user name and password credentials.
4. Select the **OCSP State**: If using OCSP, select **All**, **Required**, or **Optional**. To disable OCSP, select **Off**.
5. If you enabled the **Enable Authentication Server Validation** option, this will enable the **Select Trusted Certificate Authority(ies)** list box which contains signed Trusted Certificate Authorities (CAs) preloaded into the DM-NAX-AMP-X300.

Select the check box next to each CA whose certificate can be used for server validation, as specified by the network administrator.

If the network does not use any of the listed certificates, the network administrator must provide a certificate, which must be uploaded manually via the **Manage Certificates** functionality.

6. If required, type the domain name of the network in the **Domain** field.
7. When the 802.1X settings are configured as desired, select **Save Changes** to save the changes to the device and reboot it. Select **Revert** to cancel any changes.

DM-NAX-AUD-IO

This section describes how to configure the DM-NAX-AUD-IO.

Web Interface Configuration

The DM-NAX-2XLRI-1G web interface allows you to view status information and configure network and device settings.

Access the Web Interface

To access the web interface, do either of the following:

- [Access the Web Interface with a Web Browser on page 452](#)
- [Access the Web Interface With the Crestron Toolbox™ Application on page 454](#)

The web interface is accessed from a web browser. The following table lists operating systems and their corresponding supported web browsers.

Operating System and Supported Web Browsers

OPERATING SYSTEM	SUPPORTED WEB BROWSERS
Windows® operating system	Chrome™ web browser, version 31 and later Firefox® web browser, version 31 and later Internet Explorer web browser, version 11 and later Microsoft Edge web browser
macOS® operating system	Safari® web browser, version 6 and later Chrome web browser, version 31 and later Firefox web browser, version 31 and later

Access the Web Interface with a Web Browser

1. Enter the IP address of the DM-NAX-AUD-IO into a web browser.

NOTE: To obtain the IP address, use the **Device Discovery Tool** option in Crestron Toolbox™ application or an IP scanner application.

2. If you are creating a user account for the first time, do the following; otherwise, skip to step 3.
 - a. Enter a username in the **Username** field.
 - b. Enter a password in the **Password** field.
 - c. Re-enter the same password in the **Confirm Password** field.

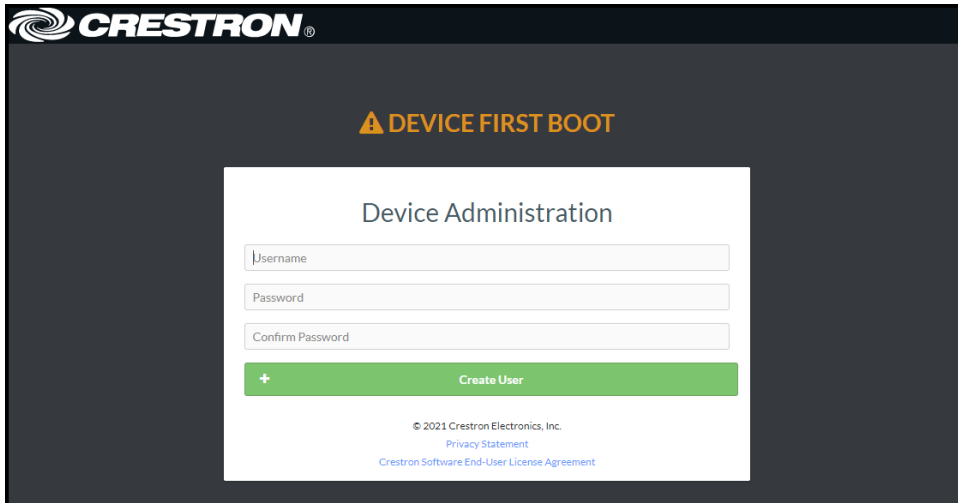

The screenshot shows the Crestron logo at the top left. Below it, a warning icon and the text "DEVICE FIRST BOOT" are displayed. The main content area is titled "Device Administration" and contains three input fields: "Username", "Password", and "Confirm Password". Below these fields is a green button with a plus sign and the text "Create User". At the bottom of the form, there is copyright information: "© 2021 Crestron Electronics, Inc.", a link for "Privacy Statement", and a link for "Crestron Software End-User License Agreement".

- d. Select **Create User**. The Device Administration page appears.

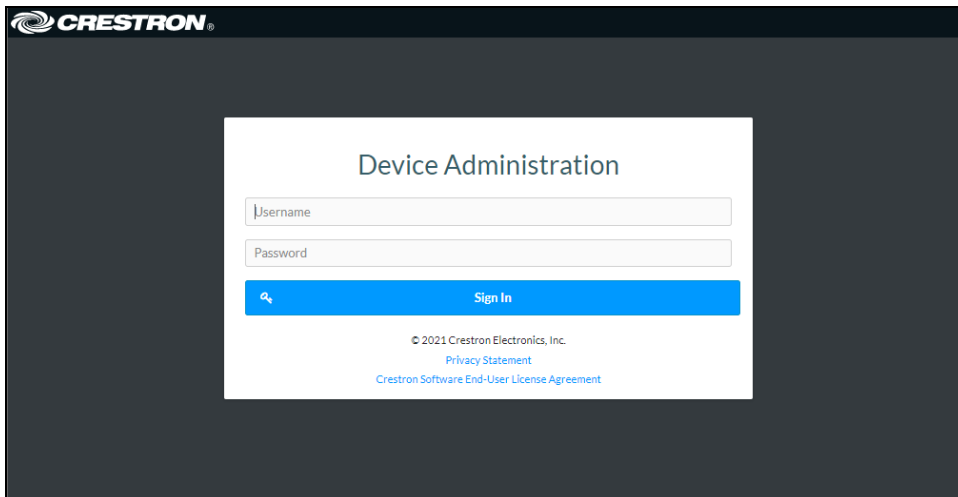

The screenshot shows the same Crestron logo at the top left. Below it, the text "DEVICE FIRST BOOT" is no longer present. The main content area is still titled "Device Administration" and contains the same three input fields: "Username", "Password", and "Confirm Password". Below these fields is a blue button with a magnifying glass icon and the text "Sign In". At the bottom of the form, there is copyright information: "© 2021 Crestron Electronics, Inc.", a link for "Privacy Statement", and a link for "Crestron Software End-User License Agreement".

3. Enter the username in the **Username** field.
4. Enter the password in the **Password** field.
5. Select **Sign In**.

Access the Web Interface With the Crestron Toolbox™ Application

To access the web interface by opening a web browser within the Crestron Toolbox™ application:

1. Open the Crestron Toolbox application.
2. From the **Tools** menu, select **Device Discovery Tool**. You can also access the Device Discovery Tool by selecting the Device Discovery Tool icon  in the Crestron Toolbox toolbar. The DM-NAX-AUD-IO is discovered and listed in the device list on the left side of the screen. The associated host name, IP address, and firmware version are also displayed.

NOTE: If there is security software running on the computer, a security alert might be displayed when the Crestron Toolbox application attempts to connect to the network. Make sure to allow the connection, so that the Device Discovery Tool can be used.

3. In the Device Discovery Tool list, select the device.
4. Enter the device credentials in the **Authentication Required** dialog that opens, then select **Log In**.
5. Select **Web Configuration**.

Action

The **Action** drop-down menu is displayed at the top right side of the interface and provides quick access to common device functions:

- [Save Changes on page 455](#)
- [Revert on page 455](#)
- [Reboot on page 456](#)
- [Restore to Factory Default Settings on page 456](#)
- [Update Firmware on page 456](#)
- [Download Logs on page 457](#)
- [Manage Certificates on page 457](#)

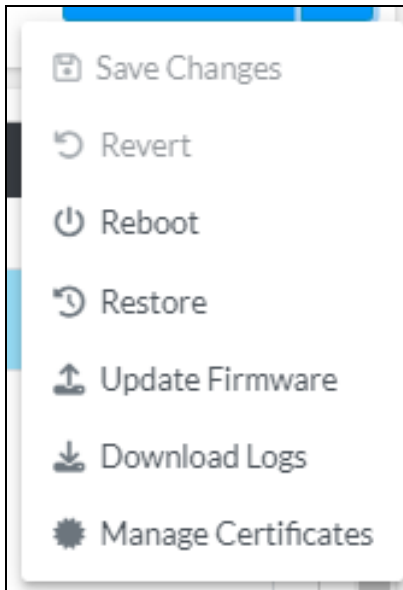

Save Changes

Select **Save Changes** to save any changes made to the configuration settings.

Revert

Select **Revert** to revert the device back to the last saved configuration settings.

Reboot

Certain changes to the settings may require the DM-NAX-AUD-IO to be rebooted to take effect. To reboot the device:

1. Select **Reboot** in the **Action** drop-down menu. The **Confirmation** message box appears.

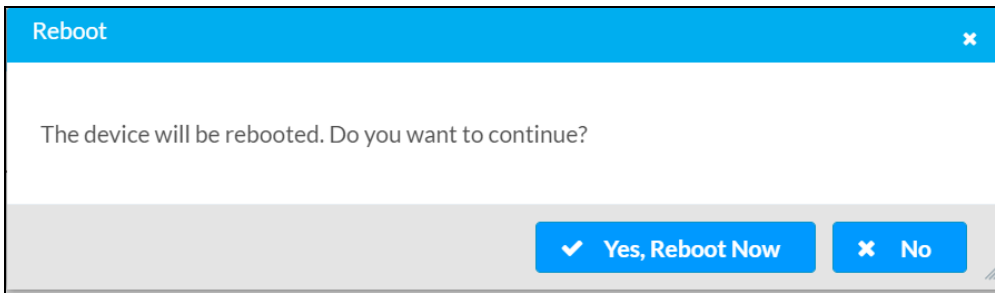

2. Select **Yes, Reboot Now** to reboot the device. The **Reboot** message box appears. Wait for the device reboot to complete before attempting to reconnect to the device.

Restore to Factory Default Settings

1. Select **Restore** in the **Action** drop-down menu to restore the settings of the DM-NAX-AUD-IO to factory defaults.

NOTE: When settings are restored, all settings, including the network settings, will revert to the factory default. If a static IP address is set, restoring the device to factory default settings will revert the IP address to the default DHCP mode.

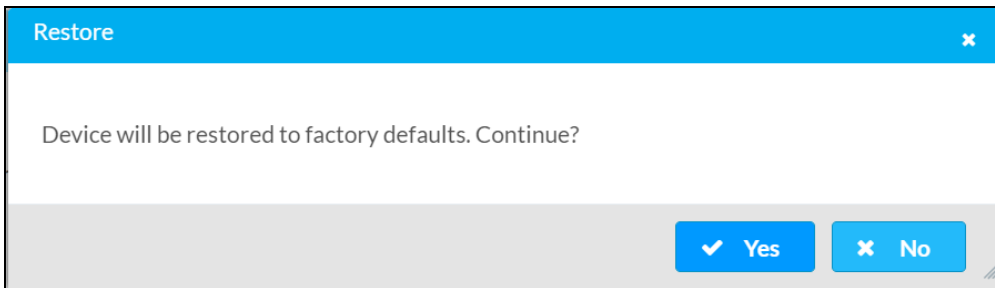

2. Select **Yes** in the **Confirmation** dialog to restore the DM-NAX-AUD-IO to factory settings. Select **No** to cancel the restore operation.

A dialog is displayed again, indicating that the restore process was successful and that the device rebooted.

You can also restore to factory settings by pressing and holding the **SETUP** button on the rear panel of the device with power disconnected then connect the power supply and continue to hold **SETUP** button for 30 seconds.

Update Firmware

1. Select **Update Firmware** in the **Action** drop-down menu.
2. In the **Firmware Upgrade** dialog, select **+ Browse**.

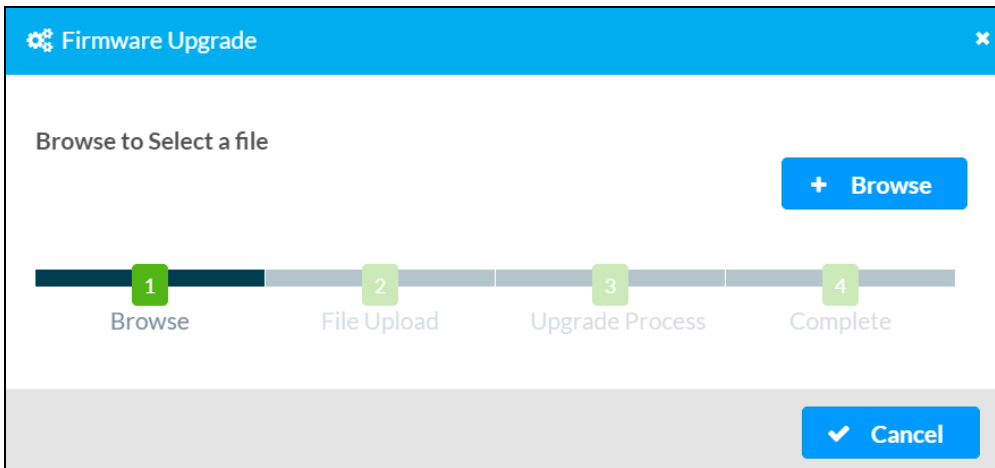

3. Locate and select the desired firmware file, and then select **Open**. The selected firmware file name is displayed in the **Firmware Upgrade** dialog.
4. Select **Load** and wait for the progress bar to complete and for **OK** to become selectable.
5. Select **OK**. The device with new firmware can now be accessed.

Download Logs

Select **Download Logs** in the **Action** drop-down menu to download the device message logs for diagnostic purposes.

The log file is downloaded to the Downloads folder of the PC.

Manage Certificates

Use the **Manage Certificates** dialog to add, remove, and manage certificates used in 802.1x and other protected networks.

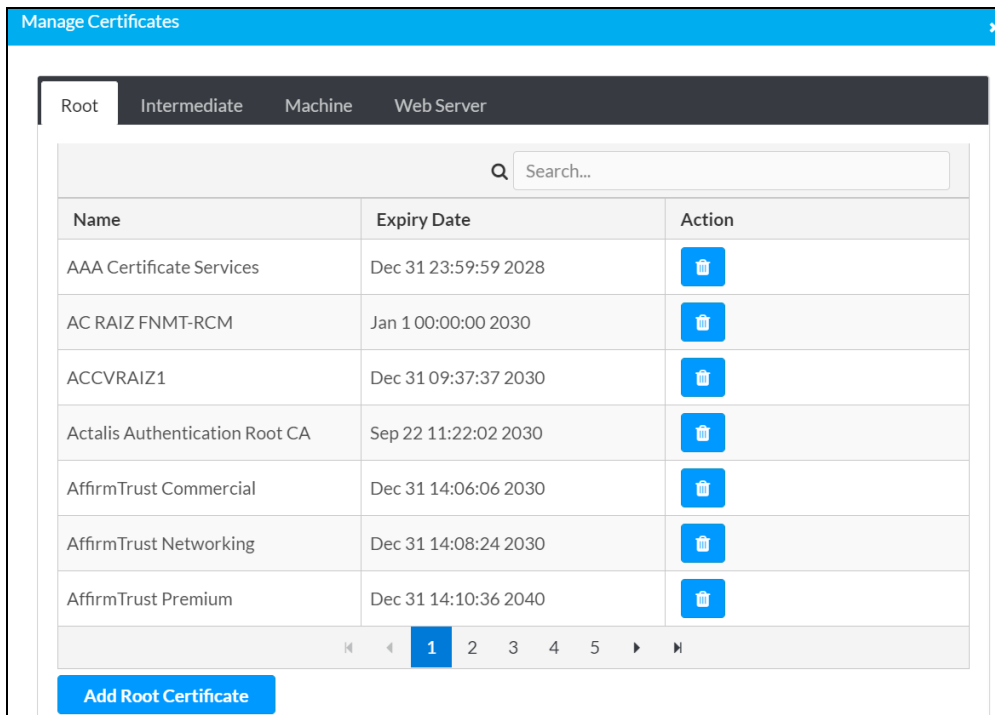

Select **Manage Certificates** in the **Action** drop-down menu. The following certificate tabs are displayed:

- **Root:** The Root certificate is used by the DM-NAX-AUD-IO to validate the network's authentication server. The DM-NAX-AUD-IO has a variety of Root certificates, self-signed by trusted CAs (Certificate Authorities) preloaded into the device. Root certificates must be self-signed.
- **Intermediate:** The Intermediate store holds non self-signed certificates that are used to validate the authentication server. These certificates will be provided by the network administrator if the network does not use self-signed Root certificates.
- **Machine:** The machine certificate is an encrypted PFX file that is used by the authentication server to validate the identity of the DM-NAX-AUD-IO. The machine certificate will be provided by the network administrator, along with the certificate password. For 802.1x, only one machine certificate can reside on the device.
- **Web Server:** The Web Server certificate is a digital file that contains information about the identity of the web server.

To Add Certificates

1. Select the corresponding certificate tab.
2. Select **Add Root Certificate**.
3. Select **+ Browse**.
4. Locate and select the file, then select **Open**.

NOTE: If the certificate is a Machine Certificate, enter the password provided by the network administrator.

5. Select **OK**. This will add the certificate to the list box, displaying the file name and expiration date. The certificate is now available for selection and can be loaded to the device.

To Delete Certificates

1. Select the corresponding certificate tab.
2. Select the trashcan icon  in the **Actions** column to delete the certificate.
3. Select **Yes** when prompted to delete the certificate or **No** to cancel the deletion.

Status

The **Status** page is the first page displayed when opening the interface of the DM-NAX-AUD-IO. It displays general information about the DM-NAX-AUD-IO (such as **Model Name**, **Firmware Version**, and **Serial Number**), current network settings (such as **Host Name** and **IP Address**, etc.), and input and output ports' current status.

The **Status** page can be accessed at any time by selecting the **Status** tab of the DM-NAX-AUD-IO interface.

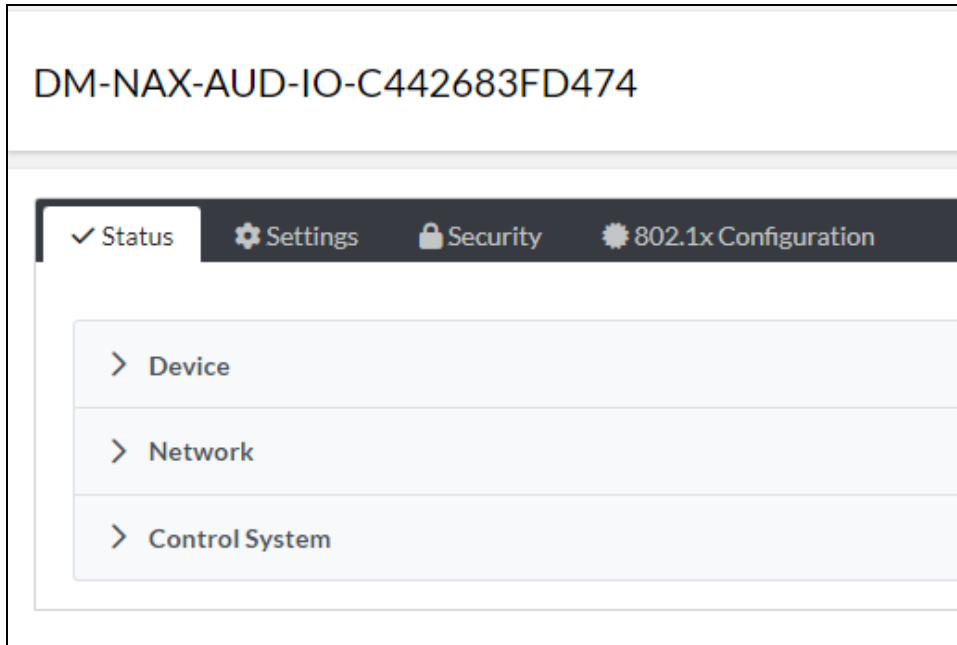

Information displayed on the **Status** page is organized into different sections.

Device

The **Device** section displays the **Model**, **Firmware Version**, and **Serial Number** of the DM-NAX-AUD-IO.

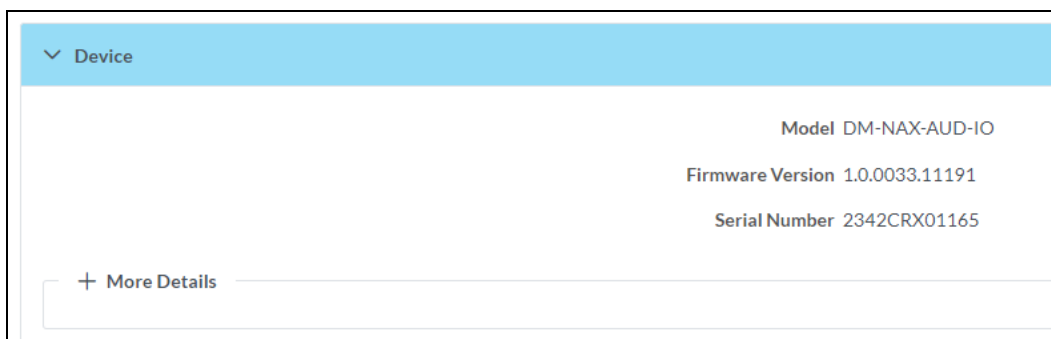

Select **+ More Details** to review additional information about the DM-NAX-AUD-IO.

— More Details

DM-NAX-AUD-IO	1.0.0033.11191
Build	Feb 13 2024 (531246)
Updater	1.0.0033.11191
Bootloader	1.00.00
CCUI Version	1.1327.1
XIOSDK	3.8.2
IoTSDK	1.11.0
Build time	11:19:07
Product ID	0x7A08
Revision ID	0x0100
HDCP2X-SKE	
HDCP2X-SKE	HDCP2X-SKE [v9.0000.00000,#FFFFFFFF]
PRE-BOOT	[v9.0000.00000]
BOOTLOADER	[v9.0000.00000]
ctrl-audio-dsp-0	FW v11 (Driver v4.00)
ctrl-extclkIn-pps	Driver v1.1
ctrl-prod-info	Driver v3.0
PUF	1.0.0033.11191
Forced Auth Mode	True

Network

The **Network** section displays network-related information about the DM-NAX-AUD-IO, including the Hostname, Domain Name, and DNS Servers.

∨ Network

Hostname	DM-NAX-AUD-IO-C442683FD474
Domain Name	CRESTRON.CRESTRON.com
DNS Servers	10.64.5.10(DHCP)
— Adapter 1	
DHCP	On
IP Address	10.64.68.171
Subnet Mask	255.255.255.0
Default Gateway	10.64.68.1
Link Active	true
MAC Address	c4.42.68.3f.d4.74

NOTE: By default, the host name of the DM-NAX-AUD-IO consists of the model name followed by the MAC address of the device. For example, DM-NAX-AUD-IO-00107FB58088.

Select **+ Adapter 1** to display an expanded section that shows additional information. If **+ Adapter 1** is selected, select **- Adapter 1** details to collapse the section.

Control System

The **Control System** section displays connection information, consisting of the following:

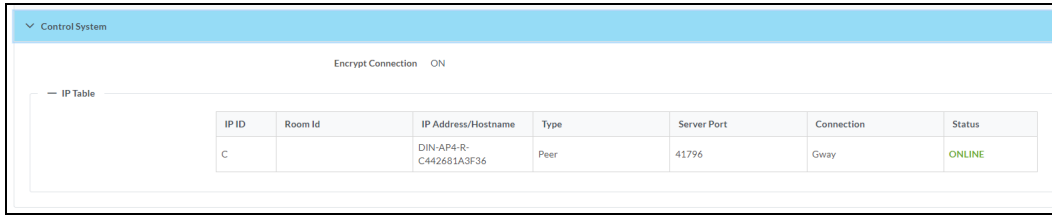

The screenshot shows a web interface for the Control System. At the top, there is a blue header with a dropdown arrow and the text "Control System". Below the header, there is a toggle switch for "Encrypt Connection" which is currently set to "ON". Underneath, there is a section titled "IP Table" which contains a table with the following data:

IP ID	Room Id	IP Address/Hostname	Type	Server Port	Connection	Status
C		DIN-AP4-R- C442681A3F36	Peer	41796	Gway	ONLINE

- **Encrypt Connection:** ON or OFF
- **IP ID:** Reports the currently used IP ID of the DM-NAX-AUD-IO
- **IP Address/Hostname:** The IP address of the control system
- **Room ID:** Displays the room ID
- **Status:** OFFLINE or ONLINE

Settings

The **Settings** page enables configuration of the DM-NAX-AUD-IO settings. The **Settings** page can be accessed at any time by selecting the **Settings** tab of the DM-NAX-AUD-IO interface.

Many options in the **Settings** page are exclusive to a specific device mode: Residential or Commercial. The DM-NAX-AUD-IO is in Commercial mode by default.

This section provides the following information:

- [Commercial Mode on page 463](#)
- [Residential Mode on page 482](#)

Commercial Mode

This section provides the following information:

- [System Setup on page 463](#)
- [Commissioning on page 468](#)
- [Output Channels on page 469](#)
- [Input Channels on page 476](#)
- [DM NAX Streams on page 477](#)
- [Mixing on page 480](#)

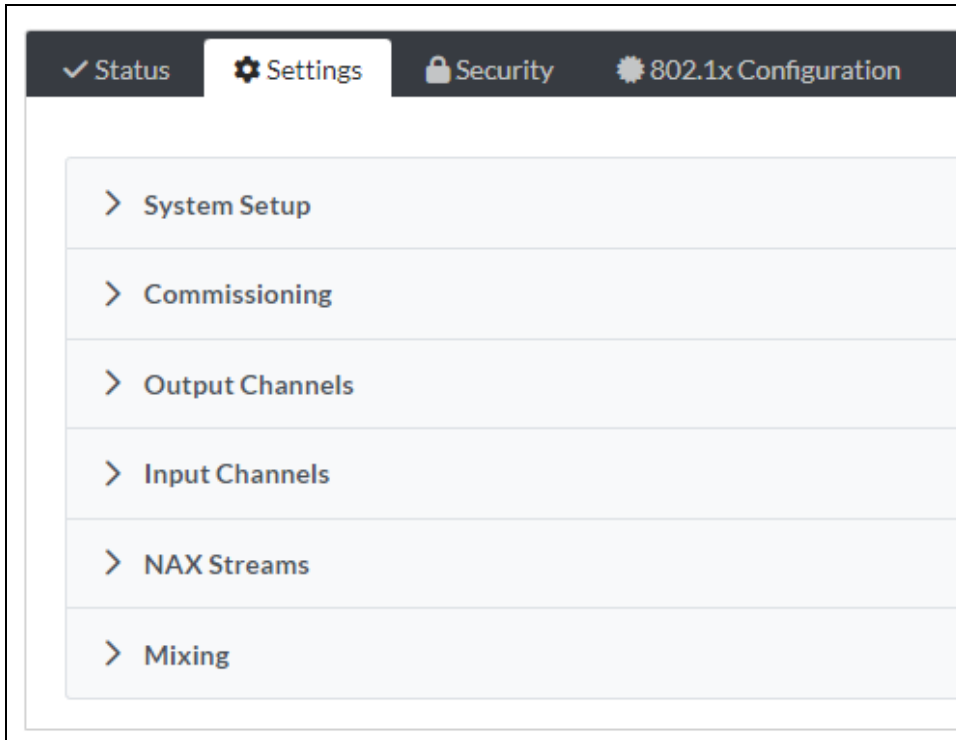

System Setup

The **System Setup** section contains settings for **Date/Time**, **Auto Update**, **Network**, and **Control System**.

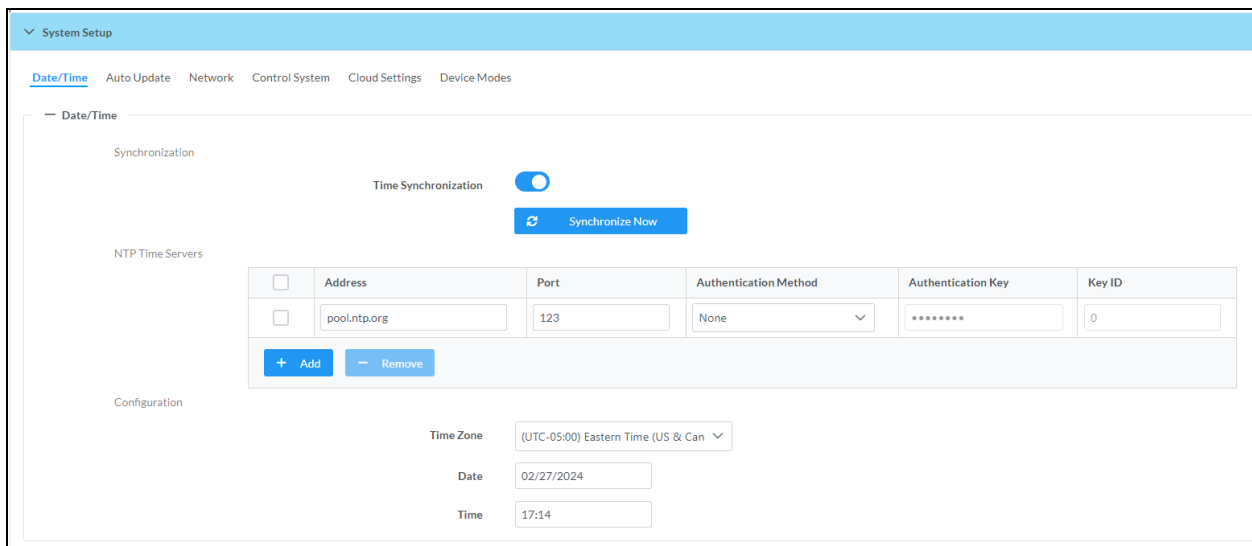

Date/Time

Use the **Date/Time** tab to configure the date and time settings of the DM-NAX-AUD-IO.

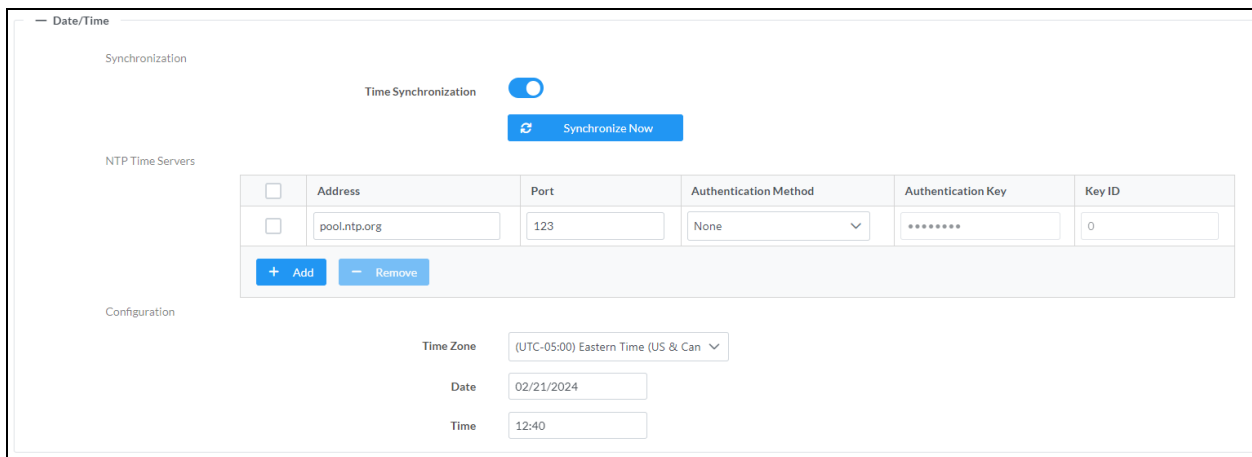

Time Synchronization

1. Set the **Time Synchronization** toggle to the right position to enable or left position to disable time synchronization. By default, time synchronization is enabled.
2. In the **NTP Time Servers** table, enter the URL of a NTP (Network Time Protocol) or SNTP (Simple Network Time Protocol) server. Up to three time servers can be added on a device.
3. Select **Synchronize Now** to perform time synchronization between the device's internal clock and the time server.

Time Configuration

1. Open the **Time Zone** drop-down menu to select the applicable time zone.
2. In the **Date** field, enter the current date.
3. In the **Time (24hr Format)** field, enter the current time in 24-hour format.

Select **Save Changes** to save the settings.

Select **Revert** from the **Action** drop-down menu to revert to the previous settings without saving.

Auto Update

The DM-NAX-AUD-IO can automatically check for and install firmware updates at scheduled intervals via the Auto Update feature.

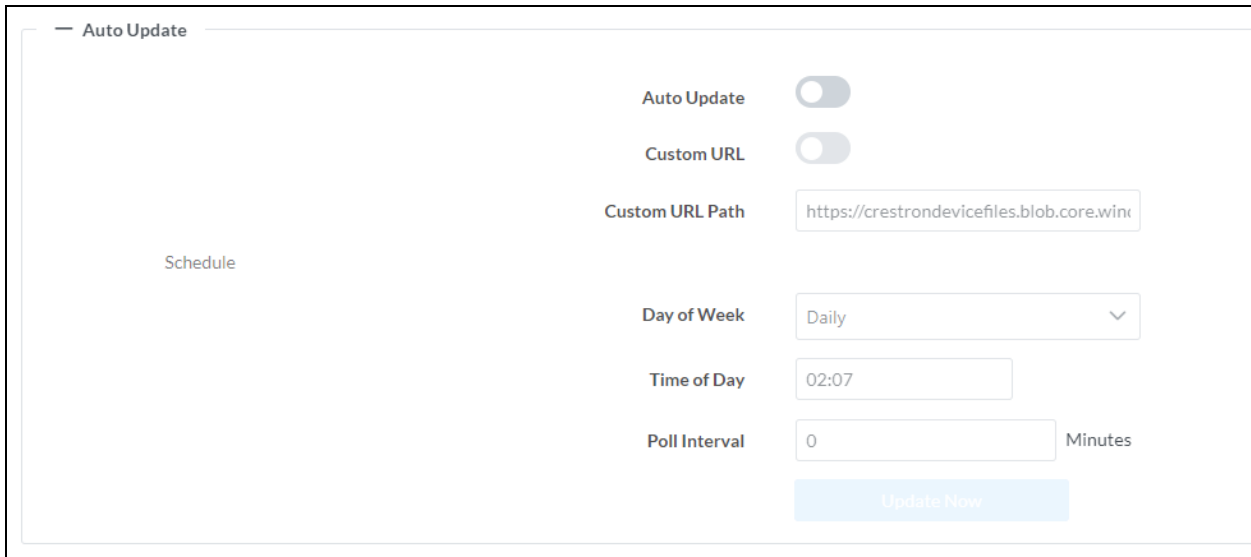

The screenshot shows the 'Auto Update' configuration page. On the left, there is a 'Schedule' section. On the right, there are several settings: 'Auto Update' (toggle switch, currently off), 'Custom URL' (toggle switch, currently off), 'Custom URL Path' (text input field containing 'https://crestrondevicefiles.blob.core.winr'), 'Day of Week' (dropdown menu set to 'Daily'), 'Time of Day' (text input field containing '02:07'), and 'Poll Interval' (text input field containing '0' with 'Minutes' to its right). At the bottom right, there is a blue 'Update Now' button.

1. Set the **Auto Update** toggle to the right position to enable Auto Update.
2. Define the URL to download the updates by doing either of the following:
 - a. Use the default URL to download the updates from the Crestron server.
 - b. Use a custom URL. Set the **Custom URL** toggle to the right position to enable a custom URL. In the **Custom URL Path** text box, enter the path to a custom manifest file in the FTP or SFTP URL format. Use the Crestron Auto Update Tool to generate a custom manifest file, then store the file on an FTP (File Transfer Protocol) or SFTP (Secure File Transfer Protocol) server.
3. Set a schedule for the automatic firmware update by doing either of the following:
 - a. Select the desired **Day of Week** and **Time of Day** (24-hour format) values.
 - b. Set the **Poll Interval** by entering a value from **60** to **65535** minutes. A value of **0** disables the Poll Interval.
4. Select **Save Changes**.

Selecting **Update Now** causes the device to check for a firmware update immediately. If a schedule was set in step 4 above, that schedule still remains in effect.

Network

The **Network** tab contains network-related settings for the DM-NAX-AUD-IO, including the Hostname, Domain, Primary Static DNS, and Secondary Static DNS.

System Setup

Date/Time Auto Update **Network** Control System Cloud Settings Device Modes

Network

Adapter 1

Hostname *	DM-NAX-AUD-IO-C442683FD474
Domain	CRESTRON.CRESTRON.com
Primary Static DNS	10.64.5.10(DHCP)
Secondary Static DNS	192.168.200.133(DHCP)
DHCP Enabled	<input checked="" type="checkbox"/>
IP Address	10.64.68.171
Subnet Mask	255.255.255.0
Default Gateway	10.64.68.1

NOTE: By default, the hostname of the DM-NAX-AUD-IO consists of the model name followed by the MAC address of the device. For example, DM-NAX-AUD-IO-00107FB58088.

Adapter 1

The Adapter 1 subheading contains settings for DHCP, IP Address, Subnet Mask, and Default Gateway of Ethernet adapter 1 on the rear panel of the device.

NOTE: DM NAX devices' internal processes use IP addresses in the 10.10.10.xxx range. This IP range should be avoided when addressing DM NAX devices to prevent conflicts.

Set the **DHCP** toggle to enabled (right) or disabled (left) to specify whether the IP address of the DM-NAX-AUD-IO is to be assigned by a DHCP (Dynamic Host Configuration Protocol) server.

- **Enabled:** When **DHCP** is enabled (default setting), the IP address of the DM-NAX-AUD-IO is automatically assigned by a DHCP server on the local area network (LAN).
- **Disabled:** When **DHCP** is disabled, manually enter information in the following fields:
 - **Primary Static DNS:** Enter a primary DNS IP address.
 - **Secondary Static DNS:** Enter a secondary DNS IP address.
 - **IP Address:** Enter a unique IP address for the DM-NAX-AUD-IO.
 - **Subnet Mask:** Enter the subnet mask that is set on the network.
 - **Default Gateway:** Enter the IP address that is to be used as the network's gateway.

To save any new network entries, select **Save Changes**.

Control System

IP ID	IP Address/Hostname	Room Id
C	DIN-AP4-R-C442681A3F36	Room Id

1. Select **Encrypt Connection** to navigate to the **Security** tab to configure encryption settings.
 - a. Enter the username in the **Control System Username** field.
 - b. Enter the password in the **Control System Password** field.
2. Select **+ Add** to add an IP table entry to the **IP Table**.
 - a. Enter the Room ID in the **Room ID** field.
 - b. Enter the IP ID of the DM-NAX-AUD-IO in the **IP ID** field.
 - c. Enter the IP address or hostname of the control system in the **IP Address/Hostname** field.
3. Select **Save Changes** to save the new entries. The **Control System Save** message box appears, indicating that the control system settings were saved successfully. Select **Revert** to revert to the previous settings without saving.

Cloud Settings

Set the **Cloud Settings** toggle to enabled (right) or disabled (left) to specify whether the DM-NAX-AUD-IO can communicate with the XiO Cloud® platform.

Device Modes

Use the **Device Modes** tab to configure the **Application Mode** of the DM-NAX-AUD-IO.

Application Mode: Commercial (Advanced)

Application Mode determines which options and controls are available.

- Select **Residential (Standard)** or **Commercial (Advanced)**. A **Reboot** confirmation message box appears.

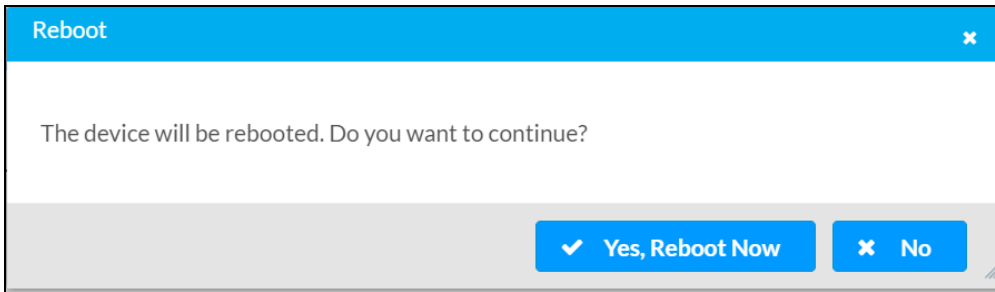

- Select **Yes, Reboot Now** to reboot the device into the selected mode. The **Reboot** message box appears.
- Wait for the device reboot to complete before attempting to reconnect to the device.

By default, the DM-NAX-AUD-IO is set to **Commercial (Advanced)** mode.

Commissioning

The **Commissioning** section provides a quick way to automatically assign multicast addresses to the device's internal audio-over-IP stream transmitters.

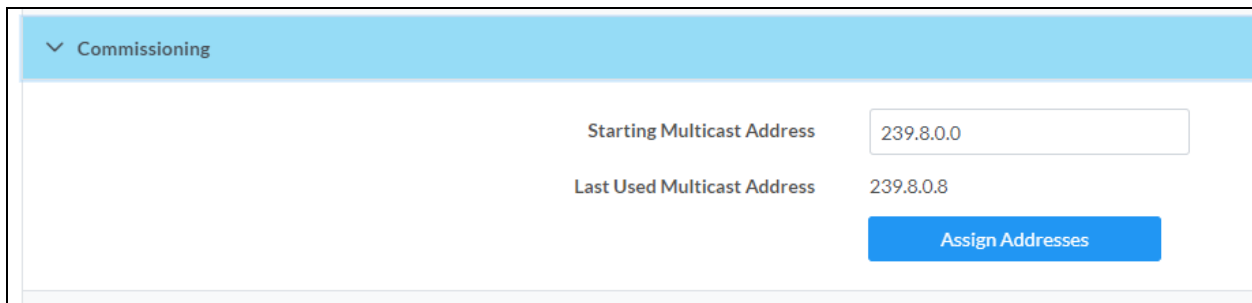

Select **Assign Addresses** to give each DM NAX transmitter in the DM-NAX-AUD-IO a unique multicast address beginning with the specified **Starting Multicast Address**. The valid range for **Starting Multicast Address** is 239.8.0.0 to 239.255.255.254.

NOTE: This will begin transmitting multicast traffic on your network. Refer to [Audio-over-IP Network Design on page 632](#) for details on proper audio-over-IP network management.

Output Channels

The **Zones** section contains the **Volume** and **Mute** settings for all zone outputs of the device, as well as an **Edit** option for more advanced settings within each zone.

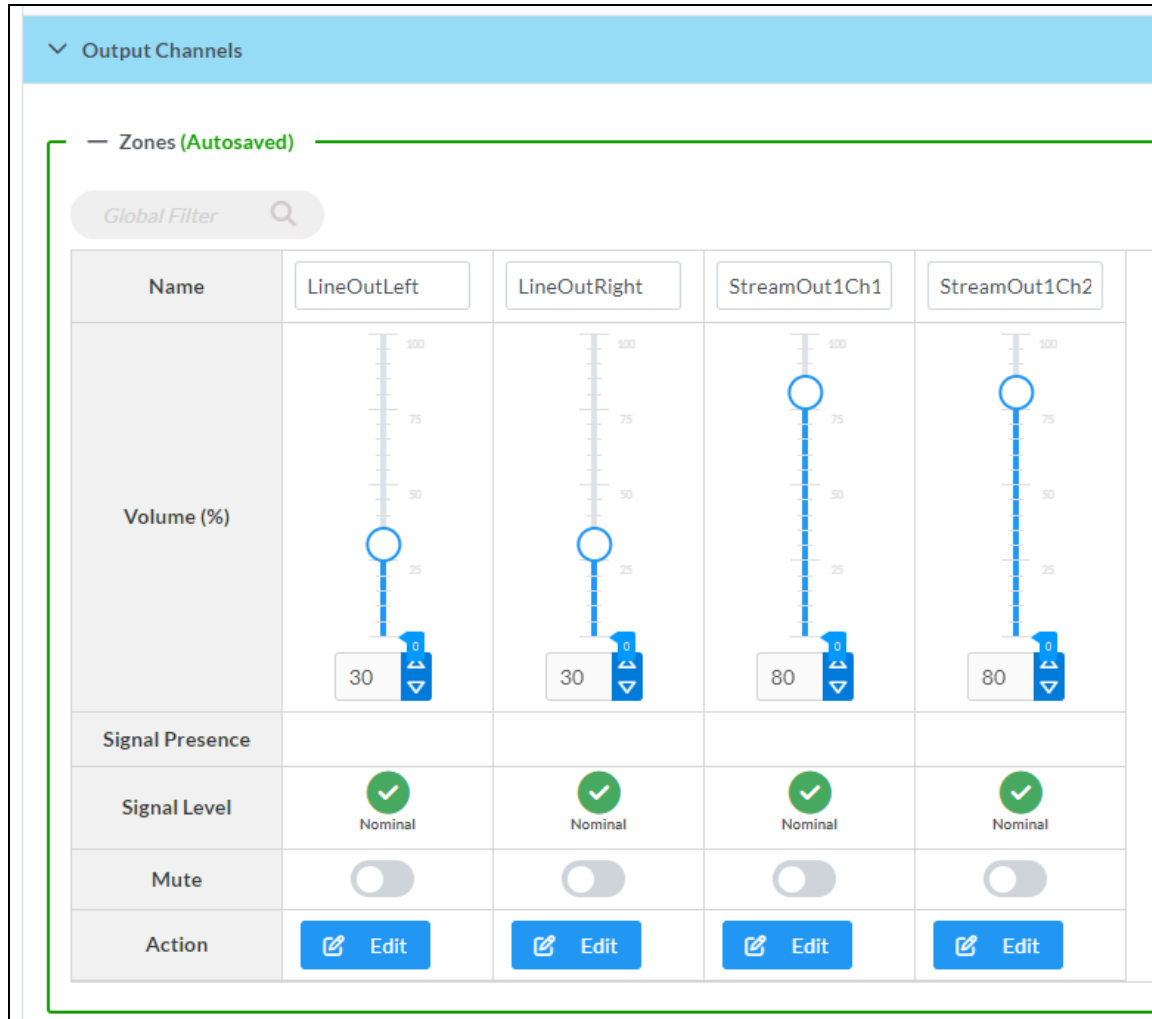

The screenshot shows a web interface for configuring output channels. At the top, there is a 'Global Filter' search bar. Below it is a table titled 'Zones (Autosaved)'. The table has five rows: Name, Volume (%), Signal Presence, Signal Level, Mute, and Action. The columns represent different output channels: LineOutLeft, LineOutRight, StreamOut1Ch1, and StreamOut1Ch2. Each channel has a volume slider and a numeric input field. The Signal Level row shows green checkmarks and the word 'Nominal' for all channels. The Mute row shows toggle switches that are currently turned off. The Action row has an 'Edit' button for each channel.

Name	LineOutLeft	LineOutRight	StreamOut1Ch1	StreamOut1Ch2
Volume (%)				
Signal Presence				
Signal Level				
Mute	<input type="checkbox"/>	<input type="checkbox"/>	<input type="checkbox"/>	<input type="checkbox"/>
Action				

Signal Presence indicates whether or not an audio signal is detected in that zone.

Signal Level indicates if the signal is **Clipping** or **Nominal** (non-clipping).

- **Nominal:** The signal level is within normal operating bounds and below the clipping threshold.
- **Clipping:** The signal level is clipping or above the -3 dB warning threshold and in danger of clipping.

Give each zone a friendly name using the **Name** column of the **Zones** table. If the device is paired with a control system, these names may be overwritten by the control system's program.

To configure the zone volume, do one of the following:

- Move the **Volume** slider up to increase or down to decrease the zone volume.
- Use the **%** arrows to increase or decrease the zone volume. Values range from 0 to 100%, adjustable in increments of 1%.
- Manually enter a value in the **Volume** field.

To mute all audio output from a zone, select its respective **Mute**. To unmute the zone, select **Muted**.
Select **Edit** to view additional **Zone** and **Output** options.

Zone Settings

To configure the settings for an output channel, select **Edit**. The **Edit Zone** window appears.

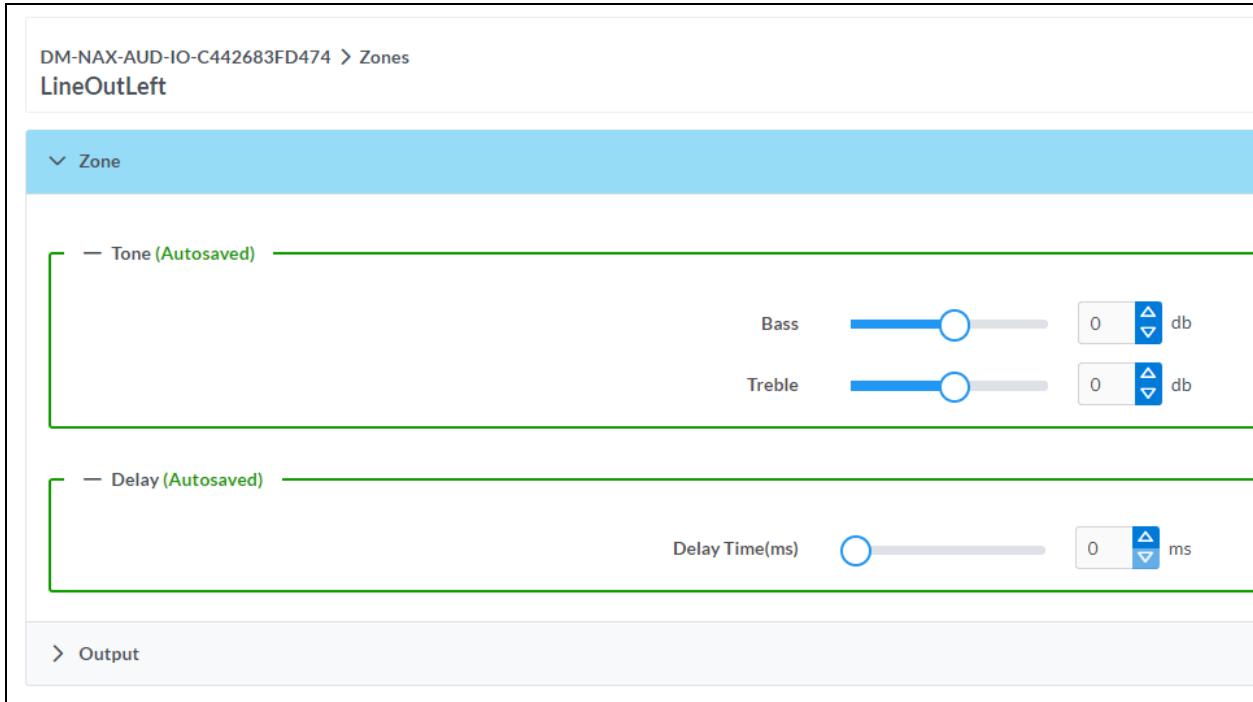

Zone

Select **Zone** to access the settings for **Tone** and **Delay**.

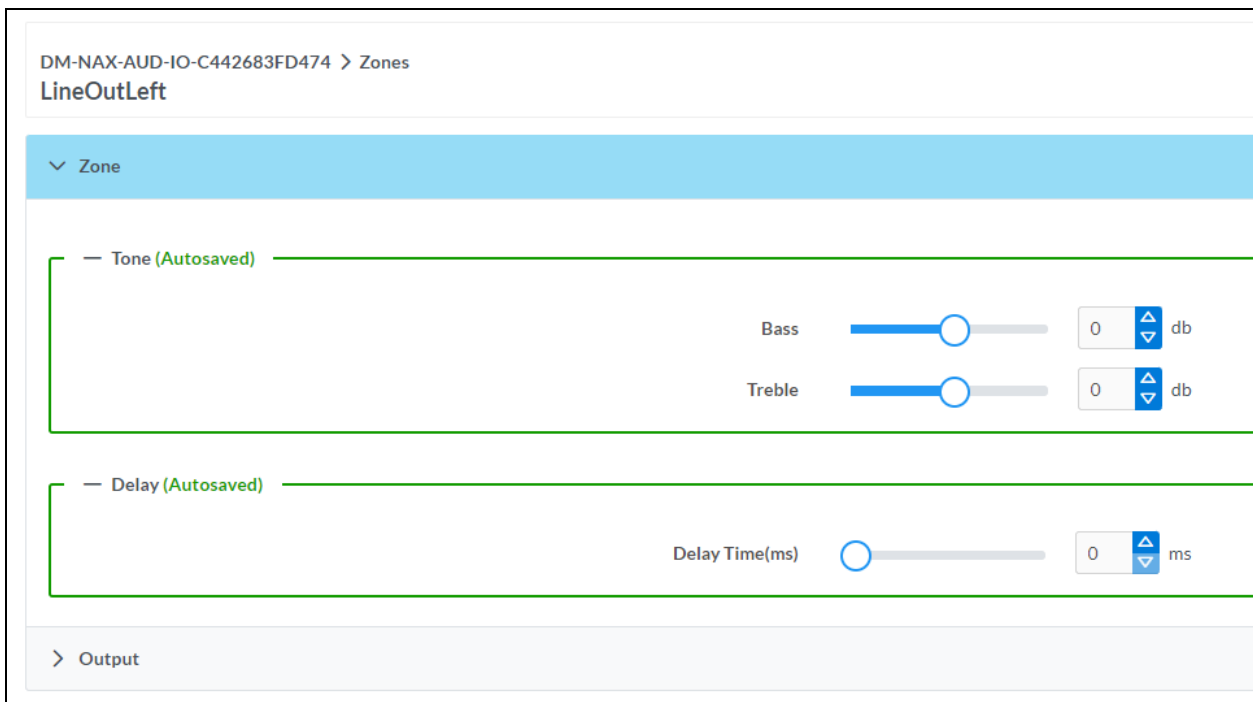

Tone

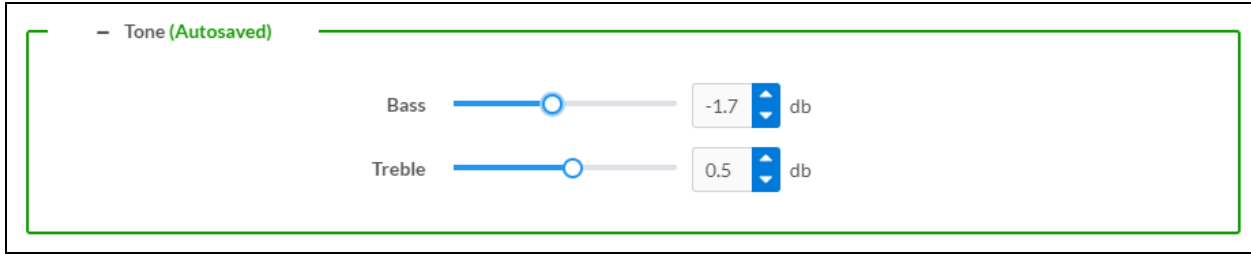

- **Bass:** To adjust the bass, do one of the following:
 - Move the **Bass** slider to the right to increase or to the left to decrease the bass db.
 - Use the **db** arrows to increase or decrease the bass level. Values range from -12 dB to 12 dB, adjustable in increments of .1 dB.
 - Manually enter a value in the **Bass** field.
- **Treble:** To adjust the treble, do one of the following:
 - Move the **Treble** slider to the right to increase or to the left to decrease the treble db.
 - Use the **db** arrows to increase or decrease the treble level. Values range from -12 dB to 12 dB, adjustable in increments of .1 dB.
 - Manually enter a value in the **Treble** field.

Delay

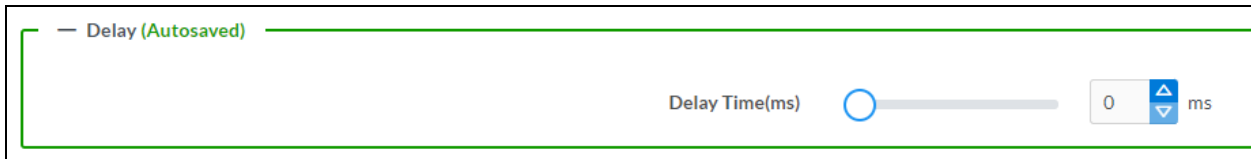

To set the delay, do one of the following:

- Move the **Delay Time(ms)** slider to the right to increase or to the left to decrease the delay time.
- Use the **ms** arrows to increase or decrease the delay. Values range from 0 ms to 85 ms, adjustable in increments of 1 ms.
- Manually enter a value in the **Delay Time(ms)** field.

NOTE: The Delay feature is only available on the line level output channels.

Output

Select **Output** to access the settings for **Minimum/Maximum Volume**, **Signal**, and the output Equalizer.

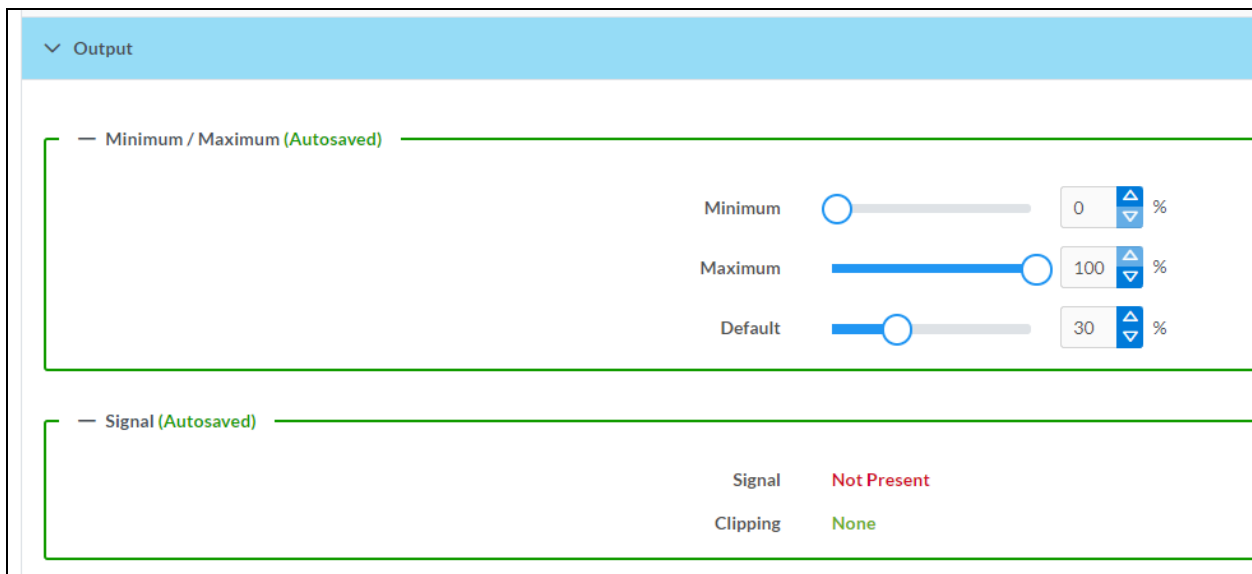

Minimum/Maximum Volume

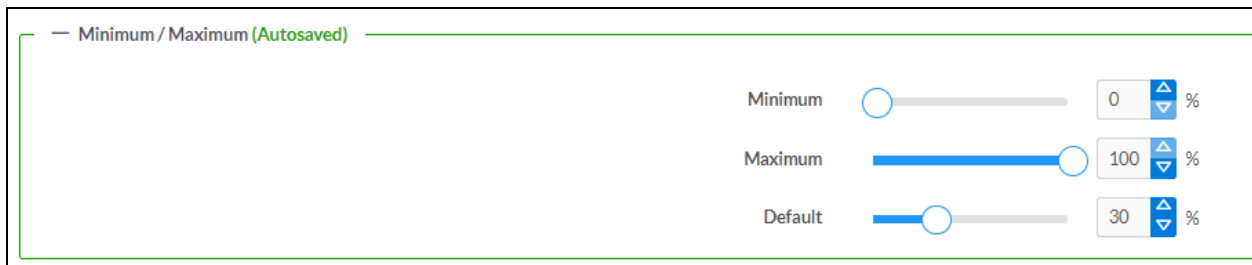

1. To set the minimum volume of the zone, do one of the following:
 - Move the **Minimum** slider to the right to increase or to the left to decrease the minimum volume.
 - Use the **%** arrows to increase or decrease the minimum volume. Values range from 0 to 50%, adjustable in increments of 1%.
 - Manually enter a value in the **Minimum** field.
2. To set the maximum volume of the zone, do one of the following:
 - Move the **Maximum** slider to the right to increase or to the left to decrease the maximum volume.
 - Use the **%** arrows to increase or decrease the maximum volume. Values range from 70 to 100%, adjustable in increments of 1%.
 - Manually enter a value in the **Maximum** field.

NOTE: When a **Minimum** and **Maximum** volume are set, the 1-100% range represented by the **Zone** and **Default** volume controls are scaled to the range set. For example, if a **Minimum** of 10% and a **Maximum** of 80% are set for a zone, the 1-100% range of the **Zone** volume control is scaled to the 10%-80% range set as the **Minimum** and **Maximum**.

3. To set the default volume of the zone, do one of the following:

- Move the **Default** slider to the right to increase or to the left to decrease the default volume.
- Use the **%** arrows to increase or decrease the default volume. Values range from 0 to 50%, adjustable in increments of 1%.
- Manually enter a value in the **Default** field.

NOTE: The **Default** volume is applied as the **Zone** volume any time the zone receives a source route and no source was previously routed to that zone.

Signal

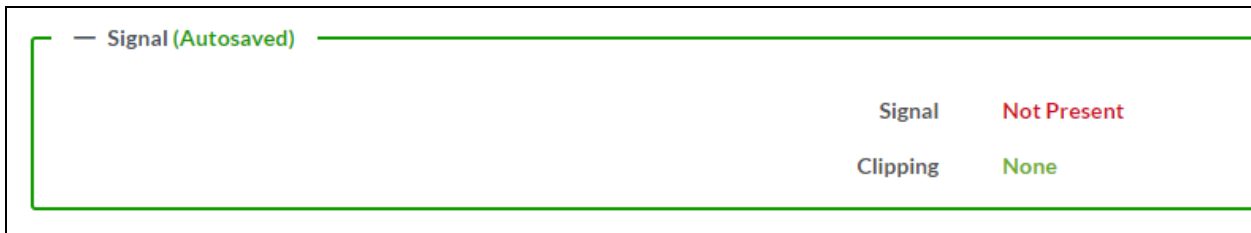

The **Signal** section is a read-only field that displays the **Signal** and **Clipping** status of the zone output.

- If an output signal is present but not clipping, **Signal** will display **Present** in green and **Clipping** will display **None** in green.
- If an output signal is present and clipping, **Signal** will display **Present** in green and **Clipping** will display **Present** in red.
- If no output signal is detected, **Signal** will display **Not Present** in red and **Clipping** will display **None** in green.

Equalizer Settings

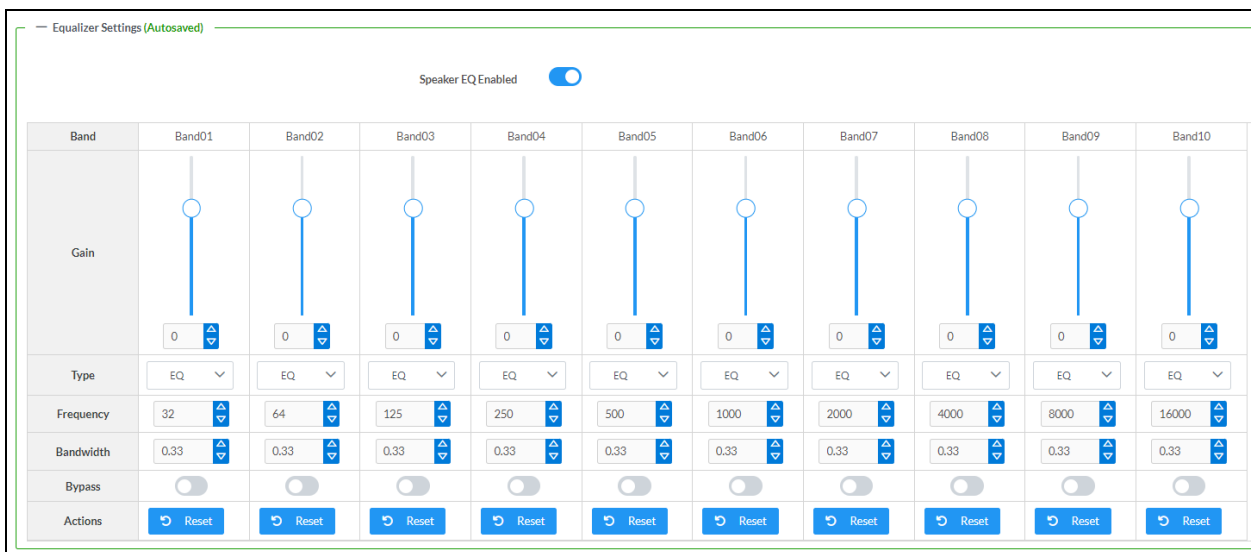

Each output channel of the DM-NAX-AUD-IO has a dedicated ten-band equalizer that can be fully customized to tune the zone output signal to the needs of an install. Each band can have a discrete gain,

filter type, center frequency, and bandwidth set, and can also be bypassed. The equalizer itself can also be bypassed using the **Speaker EQ Enabled** toggle.

1. Set the **Speaker EQ Enabled** toggle to the right position to enable the equalizer. Set the toggle to the left position to bypass the equalizer.

NOTE: When **Speaker EQ Enabled** is disabled, all equalizer bands are bypassed. This is a quick way to perform A/B testing of the entire EQ curve.

2. With the **Speaker EQ Enabled** toggle in the right position, configure the equalizer bands.
 - a. To set a band's gain, do one of the following:
 - Move the **Gain** slider up to increase or down to decrease the gain.
 - Use the arrows to increase or decrease the gain. Values range from -40 dB to 20 dB, adjustable in increments of 0.1 dB.
 - Manually enter a value in the **Gain** field.
 - b. Select a filter type from the **Type** drop-down menu. By default, all bands are set to the **EQ** filter type. Some filter types will disable other settings in their respective band while enabled. For example, selecting the **LowPass** filter type for a band will disable that band's **Gain** and **Bandwidth** settings, since the **LowPass** filter applies a fixed roll-off slope at a set frequency. The available filter types are:
 - **EQ:** a fully parametric filter that can boost or cut a range of frequencies.
 - **Notch:** a parametric filter designed to more precisely cut a frequency or range of frequencies. A notch filter can achieve a narrower bandwidth than the standard **EQ** parametric filter type.
 - **TrebleShelf:** a filter that boosts or cuts all frequencies above a set frequency by a set gain.
 - **BassShelf:** a filter that boosts or cuts all frequencies below a set frequency by a set gain.
 - **LowPass:** a filter that fully cuts all frequencies above a set frequency using a fixed roll-off slope of -12 dB per octave.
 - **HighPass:** a filter that fully cuts all frequencies below a set frequency using a fixed roll-off slope of -12 dB per octave.
 - c. Set a center frequency for the equalizer band to tune a specific portion of the audible frequency spectrum. To set the center frequency, do one of the following:
 - Use the arrows to increase or decrease the frequency. Values range from 20 Hz to 20 kHz, adjustable in increments of 1 Hz. Each band has a default center frequency that will be applied if **Reset** at the bottom of the band is selected.
 - Manually enter a value in the **Frequency** field.
 - d. Set a bandwidth to determine how wide of a frequency range is effected by the equalizer band. To set the bandwidth, do one of the following:
 - Use the arrows to increase or decrease the bandwidth. Values range from 0.1 octaves to 4.0 octaves, adjustable in increments of 0.1 octave.
 - Manually enter a value in the **Bandwidth** field.

- e. The individual Bypass controls allow you to bypass a single band of equalization at a time for more granular A/B testing of a single filter. Set a band's **Bypass** toggle to the right position to bypass that band. Set the toggle to the left position to disable the bypass. By default, **Bypass** is disabled.
- f. Each equalizer band has a **Reset** that will reapply the default settings for that band.

Select **Done** to return to the **Settings** tab of the web user interface.

Input Channels

The **Input Channels** section is used to configure the **Name**, **Compensation**, and **Mute** attributes of the front panel line inputs on the DM-NAX-AUD-IO.

The screenshot shows the 'Input Channels' configuration page. It features a table with columns for each input channel and rows for various settings. The 'Analog Gain (db)' row shows values of 17 for LineInLeft and LineInRight, and empty fields for StreamIn1Ch1 and StreamIn1Ch2. The 'Compensation (db)' row shows sliders and numeric input fields (all set to 0) for each channel. The 'Signal Present' row shows green checkmarks for StreamIn1Ch1 and StreamIn1Ch2. The 'Signal Level' row shows 'Nominal' for all channels. The 'Mute' row shows toggle switches for all channels, all currently turned off.

Input Channels				
— Analog Inputs (Autosaved)				
Name	LineInLeft	LineInRight	StreamIn1Ch1	StreamIn1Ch2
Analog Gain (db)	17	17		
Compensation (db)				
Signal Present				
Signal Level	 Nominal	 Nominal	 Nominal	 Nominal
Mute	<input type="checkbox"/>	<input type="checkbox"/>	<input type="checkbox"/>	<input type="checkbox"/>

Configure Inputs

1. If needed, enter a friendly name for each input in its **Name** field.
2. To set an analog gain value for a given input, use the **db** arrows to increase or decrease the gain. Values range from 0 dB to 60 dB, adjustable in increments of 1 dB.
3. To set a level compensation adjustment for a given input, do one of the following:
 - Move the **Compensation** slider up to increase or down to decrease the level compensation. Compensation increases or decreases the level of the incoming audio signal on any of the physical inputs on the device's rear panel.
 - Use the **db** arrows to increase or decrease the compensation. Values range from -10 dB to 10 dB, adjustable in increments of 1 dB.
 - Manually enter a value in the **Compensation** field.
4. To mute the signal from the corresponding input, set the **Mute** toggle to the right. To disable the mute, set the **Mute** toggle to the left. By default, **Mute** is disabled.

Monitor the device's input signals using the text indicators in the **Signal Present** and **Clipping Detected** columns:

- **Signal Presence** indicates whether or not a signal is detected in that zone.
- **Clipping Detected** indicates if the signal is **Clipping** or **Nominal** (non-clipping).

DM NAX Streams

The local inputs of the DM-NAX-AUD-IO can be made available as a DM NAX audio-over-IP stream.

Select **NAX Streams** to expand the tab and display the following information.

▼ NAX Streams

This Device is the Leader PTP Clock Source **No**

PTP Clock Leader MAC Address 00:10:7f:9c:1fe9

PTP Priority 254

— Transmitters (Autosaved)

Audio Source	Stream	Nax Stream Address	Nax Stream Name	Status	Actions
StreamOut1Ch1	Stream01	0.0.0.0	Stream01c4.42.68.3fb8ac	Stream Stopped	▶ ⏸ ⚙

— Receivers (Autosaved)

Zone Name	Stream	Current Stream Address	Requested Stream Address	Status	Actions
StreamIn1Ch1	Stream01	0.0.0.0	0.0.0.0	Stream Stopped	▶ ⏸ ⚙

- **Device is Leader PTP Clock Source** indicates whether the DM NAX device's PTP clock is the leader clock on the network. **Yes** will be displayed in green when the local DM-NAX-AUD-IO's clock is the PTP leader clock and **No** will be displayed in red when another PTP clock on the network is operating as the leader clock.
- **Leader Clock Status** displays the Leader Clock ID of the device on the network that is currently acting as the leader clock.
- **PTP Priority**: This sets the priority of the local DM NAX device's PTP clock relative to other clocks on the network. The default setting is 254 (one increment higher than the lowest possible value) so that the DM-NAX-AUD-IO will only operate as the leader clock if no other PTP leader is present on the network. Valid values range from 1 to 255.

Configure Transmitters

To configure the DM NAX transmit stream:

1. Enter a valid multicast address in the **NAX Stream Address** field.
2. Enter a name in the **NAX Stream Name** field by which the stream can be identified. This stream name is associated with the DM NAX stream's multicast address by other DM NAX or AES67 devices, like a device hostname that resolves to a given IP address.
3. **Status** indicates whether a stream is transmitting or not. When the stream has started or stopped, the **Status** column will update accordingly.
4. Select the configure icon ⚙ in the **Actions** column. The **Configure** dialog appears:

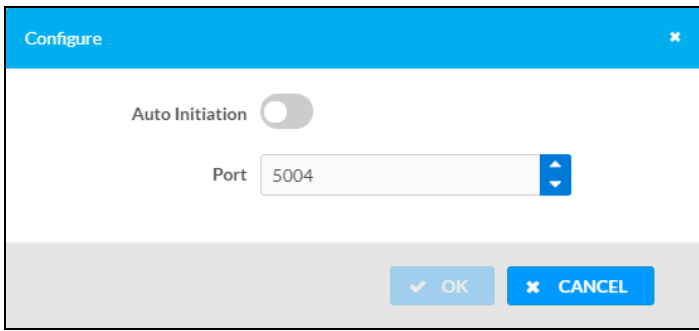

5. Set the **Auto Initiation** toggle to the right position to enable auto initiation. Set the toggle to the left position to disable auto initiation.
 - If **Auto Initiation** is enabled for a given stream, the stream will begin transmitting automatically and will be available as a multicast stream on your network at the specified multicast address.
 - If **Auto Initiation** is disabled for the input, the stream will not begin transmitting until it is manually initiated.
6. To set the port number, do one of the following:
 - Use the arrows to increase or decrease the port number by increments of 1.
 - Manually enter a port number in the **Port** field. The default port number for DM NAX streams is 5004.
7. Select **OK** to save or select **Cancel** to cancel the changes.

Configure Receivers

1. Enter the multicast address of a transmitting stream in the **Requested Stream Address** field to subscribe the receiver to the stream.
2. Select the configure icon  in the **Actions** column. The **Configure** dialog appears:

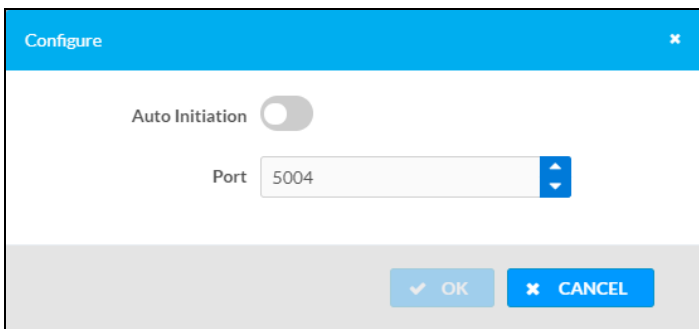

3. Set the **Auto Initiation** toggle to the right position to enable auto initiation. Set the toggle to the left position to disable auto initiation.
 - If **Auto Initiation** is enabled, the stream will begin automatically when the receiver subscribes to the transmitter.
 - If **Auto Initiation** is disabled, the stream will not begin until it is manually initiated.

4. To set the port number, do one of the following:
 - Use the arrows to increase or decrease the port number by increments of 1.
 - Manually enter a port number in the **Port** field. The default port number is 5004.
5. Select **OK** to save or select **Cancel** to cancel the changes.

Mixing

The **Mixing** matrix is used to route a local input or AES67 stream to an output on the DM-NAX-AUD-IO.

NOTE: To receive an AES67 stream from Dante devices, see [OLH 1001151](#).

The screenshot displays a mixing matrix interface. On the left, a vertical bar labeled "Inputs(5)" lists five input sources: LineInLeft, LineInRight, StreamIn1Ch1, StreamIn1Ch2, and signalGen. On the right, a horizontal bar labeled "Outputs(4)" lists four output destinations: LineOutLeft, LineOutRight, StreamOut1Ch1, and StreamOut1Ch2. The matrix cells are arranged in a grid. The "LineInLeft" row has audio icons and "0 dB" labels in the "LineOutLeft" and "StreamOut1Ch1" columns. The "LineInRight" row has audio icons and "0 dB" labels in the "LineOutRight" and "StreamOut1Ch2" columns. The "StreamIn1Ch1" and "StreamIn1Ch2" rows have green checkmarks in their respective input cells. The "signalGen" row is empty. A legend at the bottom identifies the colors: green for Inputs, blue for Outputs, a speaker icon for Audio, and a checkmark for "Select For All Outputs".

To route inputs to outputs on the device:

- Select the cells corresponding to the desired output that are to be paired for routing. Once a route is made, appears. The input that you have selected for a given row will route to the output corresponding to that row in the matrix.
- To break a given route select or .

Each output can have any number of inputs routed to it. To adjust the mix setting for a route, select the **dB** value of the cell, then do one of the following:

- Move the slider up to increase or down to decrease the mix level.
- Use the arrows to increase or decrease the mix level.
- Manually enter a value in the field.

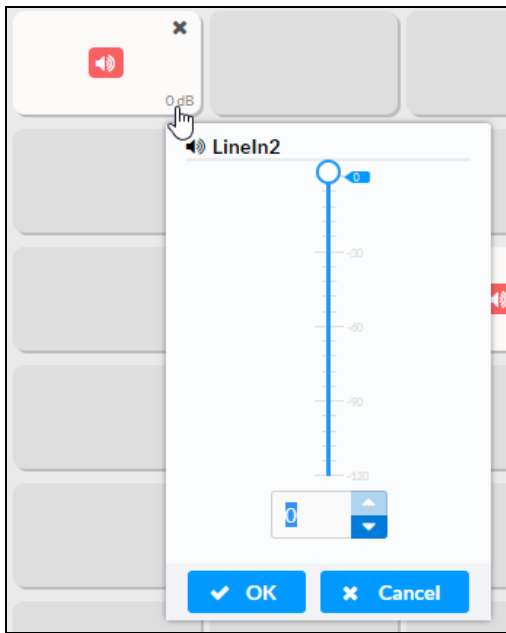

Residential Mode

This section provides the following information:

- [System Setup on page 482](#)
- [Commissioning on page 487](#)
- [Output Channels on page 488](#)
- [Inputs on page 495](#)
- [NAX Streams on page 496](#)
- [Routing on page 499](#)

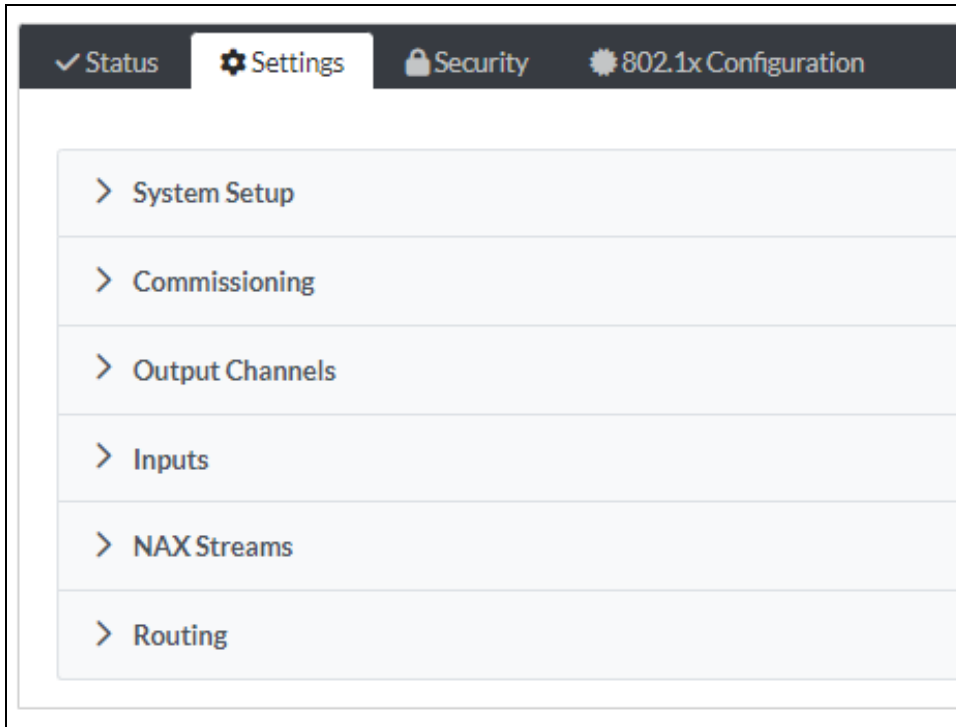

System Setup

The **System Setup** section displays information about the Date/Time, Auto Update, Network, Control System, Cloud Settings, and Device Modes.

Date/Time

Use the **Date/Time** section to configure the date and time settings of the DM-NAX-AUD-IO.

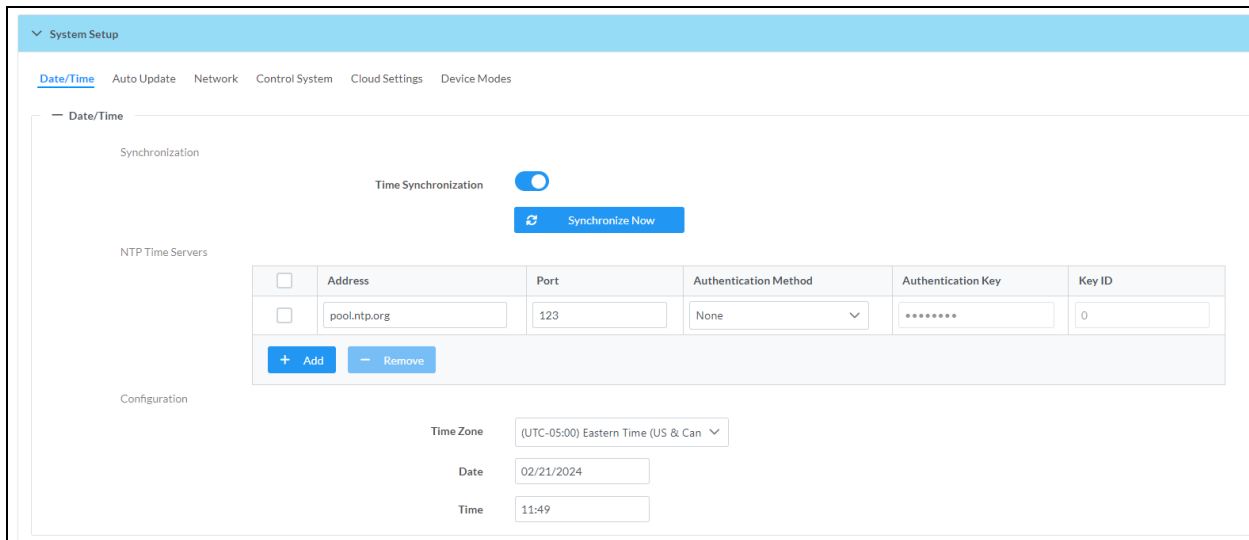

Time Synchronization

1. Set the **Time Synchronization** toggle to the right position to enable or left position to disable time synchronization. By default, time synchronization is enabled.
2. In the **NTP Time Servers** table, enter the URL of a NTP (Network Time Protocol) or SNTP (Simple Network Time Protocol) server. Up to three time servers can be added on a device.
3. Select **Synchronize Now** to perform time synchronization between the device's internal clock and the time server.

Time Configuration

1. Open the **Time Zone** drop-down menu to select the applicable time zone.
2. In the **Date** field, enter the current date.
3. In the **Time (24hr Format)** field, enter the current time in 24-hour format.

Select **Save Changes** to save the settings.

Select **Revert** from the **Action** drop-down menu to revert to the previous settings without saving.

Auto Update

The DM-NAX-AUD-IO can automatically check for and install firmware updates at scheduled intervals via the Auto Update feature.

The screenshot shows the 'Auto Update' configuration page in a web interface. At the top, there is a navigation bar with 'System Setup' and several menu items: 'Date/Time', 'Auto Update' (which is selected and underlined), 'Network', 'Control System', 'Cloud Settings', and 'Device Modes'. Below the navigation bar, the 'Auto Update' section is visible. It contains several settings:

- 'Auto Update' toggle: Turned on (blue).
- 'Custom URL' toggle: Turned off (grey).
- 'Custom URL Path' text box: Contains the URL 'https://crestrondevicefiles.blob.core.win...'.
- 'Day of Week' dropdown: Set to 'Daily'.
- 'Time of Day' text box: Set to '02:25'.
- 'Poll Interval' text box: Set to '0', with 'Minutes' written next to it.

At the bottom right of the settings area, there is a blue button labeled 'Update Now'.

1. Set the **Auto Update** toggle to the right position to enable Auto Update.
2. Define the URL to download the updates by doing either of the following:
 - a. Use the default URL to download the updates from the Crestron server.
 - b. Use a custom URL. Set the **Custom URL** toggle to the right position to enable a custom URL. In the **Custom URL Path** text box, enter the path to a custom manifest file in the FTP or SFTP URL format. Use the Crestron Auto Update Tool to generate a custom manifest file, then store the file on an FTP (File Transfer Protocol) or SFTP (Secure File Transfer Protocol) server.
3. Set a schedule for the automatic firmware update by doing either of the following:
 - a. Select the desired **Day of Week** and **Time of Day** (24-hour format) values.
 - b. Set the **Poll Interval** by entering a value from **60** to **65535** minutes. A value of **0** disables the Poll Interval.
4. Select **Save Changes**.

Selecting **Update Now** causes the device to check for a firmware update immediately. If a schedule was set in step 4 above, that schedule still remains in effect.

Network

The **Network** section contains network-related settings for the DM-NAX-AUD-IO, including the Hostname, Domain, Primary Static DNS, and Secondary Static DNS.

System Setup

Date/Time Auto Update **Network** Control System Cloud Settings Device Modes

Network

Adapter 1

Hostname *	DM-NAX-AUD-IO-C442683FD474
Domain	CRESTRON.CRESTRON.com
Primary Static DNS	10.64.5.10(DHCP)
Secondary Static DNS	192.168.200.133(DHCP)
DHCP Enabled	<input checked="" type="checkbox"/>
IP Address	10.64.68.171
Subnet Mask	255.255.255.0
Default Gateway	10.64.68.1

NOTE: By default, the host name of the DM-NAX-AUD-IO consists of the model name followed by the MAC address of the device. For example, DM-NAX-AUD-IO-00107FB58088.

Adapter 1

The Adapter 1 subheading contains settings for DHCP, IP Address, Subnet Mask, and Default Gateway of Ethernet adapter 1 on the rear panel of the device.

NOTE: DM NAX devices' internal processes use IP addresses in the 10.10.10.xxx range. This IP range should be avoided when addressing DM NAX devices to prevent conflicts.

Set the **DHCP** toggle to enabled (right) or disabled (left) to specify whether the IP address of the DM-NAX-AUD-IO is to be assigned by a DHCP (Dynamic Host Configuration Protocol) server.

- **Enabled:** When DHCP is enabled (default setting), the IP address of the DM-NAX-AUD-IO is automatically assigned by a DHCP server on the local area network (LAN).
- **Disabled:** When DHCP is disabled, manually enter information in the following fields:
 - **Primary Static DNS:** Enter a primary DNS IP address.
 - **Secondary Static DNS:** Enter a secondary DNS IP address.
 - **IP Address:** Enter a unique IP address for the DM-NAX-AUD-IO.
 - **Subnet Mask:** Enter the subnet mask that is set on the network.
 - **Default Gateway:** Enter the IP address that is to be used as the network's gateway.

To save any new network entries, select **Save Changes**.

Control System

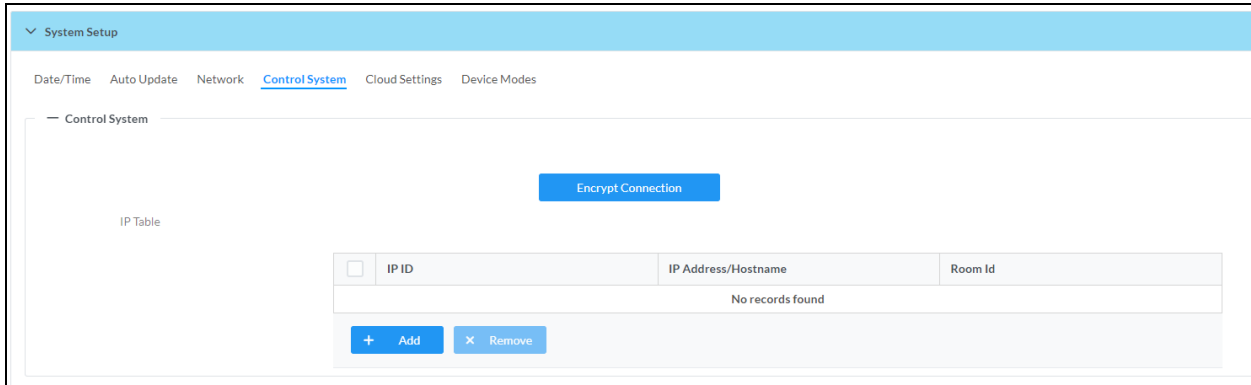

1. Select **Encrypt Connection** to navigate to the **Security** tab to configure encryption settings.
 - a. Enter the username in the **Control System Username** field.
 - b. Enter the password in the **Control System Password** field.
2. Select **+ Add** to add an IP table entry to the **IP Table**.
 - a. Enter the Room ID in the **Room ID** field.
 - b. Enter the IP ID of the DM-NAX-AUD-IO in the **IP ID** field.
 - c. Enter the IP address or hostname of the control system in the **IP Address/Hostname** field.
3. Select **Save Changes** to save the new entries. The **Control System Save** message box appears, indicating that the control system settings were saved successfully. Select **Revert** to revert to the previous settings without saving.

Cloud Settings



Set the **Cloud Settings** toggle to enabled (right) or disabled (left) to specify whether the DM-NAX-AUD-IO can communicate with the XiO Cloud® platform.

Device Modes

Use the **Device Modes** section to configure the **Application Mode**.

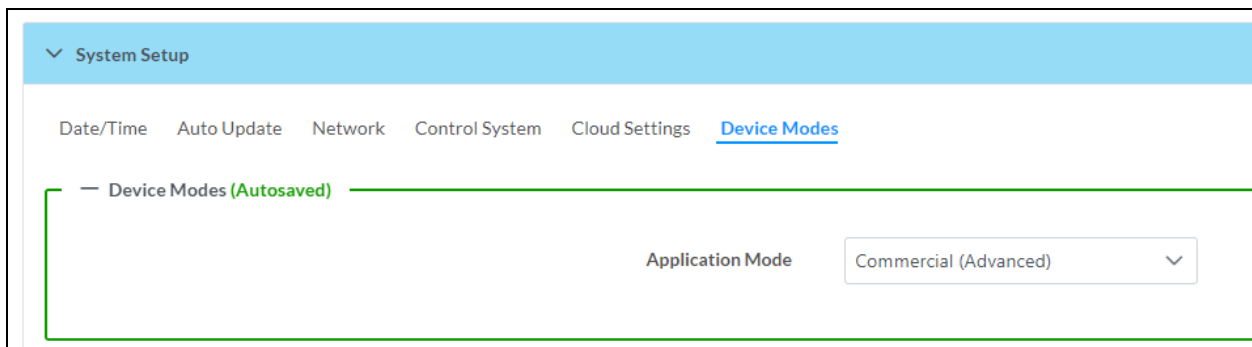

- **Application Mode:** The Application Mode determines which options and controls are available.
 - Select **Residential (Standard)** or **Commercial (Advanced)**. A **Reboot** confirmation message box appears.

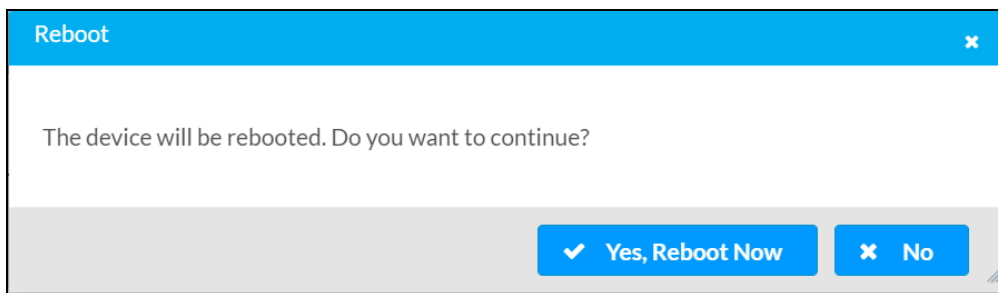

- Select **Yes, Reboot Now** to reboot the device into the selected mode. The **Reboot** message box appears.
- Wait for the device reboot to complete before attempting to reconnect to the device.

Commissioning

The **Commissioning** section provides a quick way to automatically assign multicast addresses to the device's internal audio-over-IP stream transmitters.

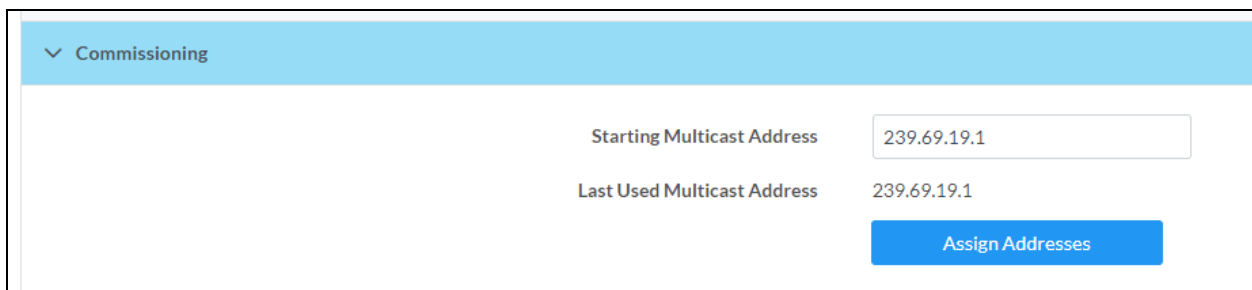

Select **Assign Addresses** to give each DM NAX transmitter in the DM-NAX-AUD-IO a unique multicast address beginning with the specified **Starting Multicast Address**. The valid range for **Starting Multicast Address** is 239.8.0.0 to 239.127.255.254.

NOTE: This will begin transmitting multicast traffic on your network. Refer to [Audio-over-IP Network Design on page 632](#) for details on proper audio-over-IP network management.

Output Channels

The **Zones** section contains the **Volume** and **Mute** settings for all zone outputs of the device, as well as a **Configure** option for more advanced settings within each zone.

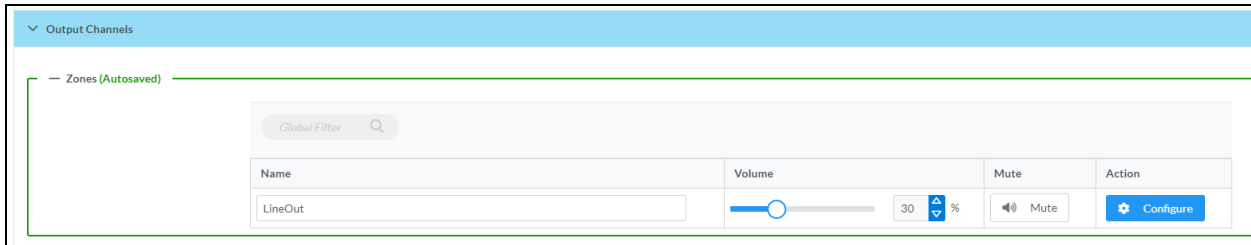

Give each zone a friendly name using the **Name** column of the **Zones** table. If the device is paired with a control system, these names may be overwritten by the control system's program.

To configure the zone volume, do one of the following:

- Move the **Volume** slider to the right to increase or to the left to decrease the zone volume.
- Use the **%** arrows to increase or decrease the zone volume. Values range from 0 to 100%, adjustable in increments of 1%.
- Manually enter a value in the **Volume** field.

To mute all audio output from a zone, select its respective **Mute**. To unmute the zone, select **Muted**.

Zone Settings

To configure zone settings, select **Configure** (). The **Edit Zone** window appears.

Zone

Select **Zone** to access the settings for **Tone**, **Balance**, and **Delay**.

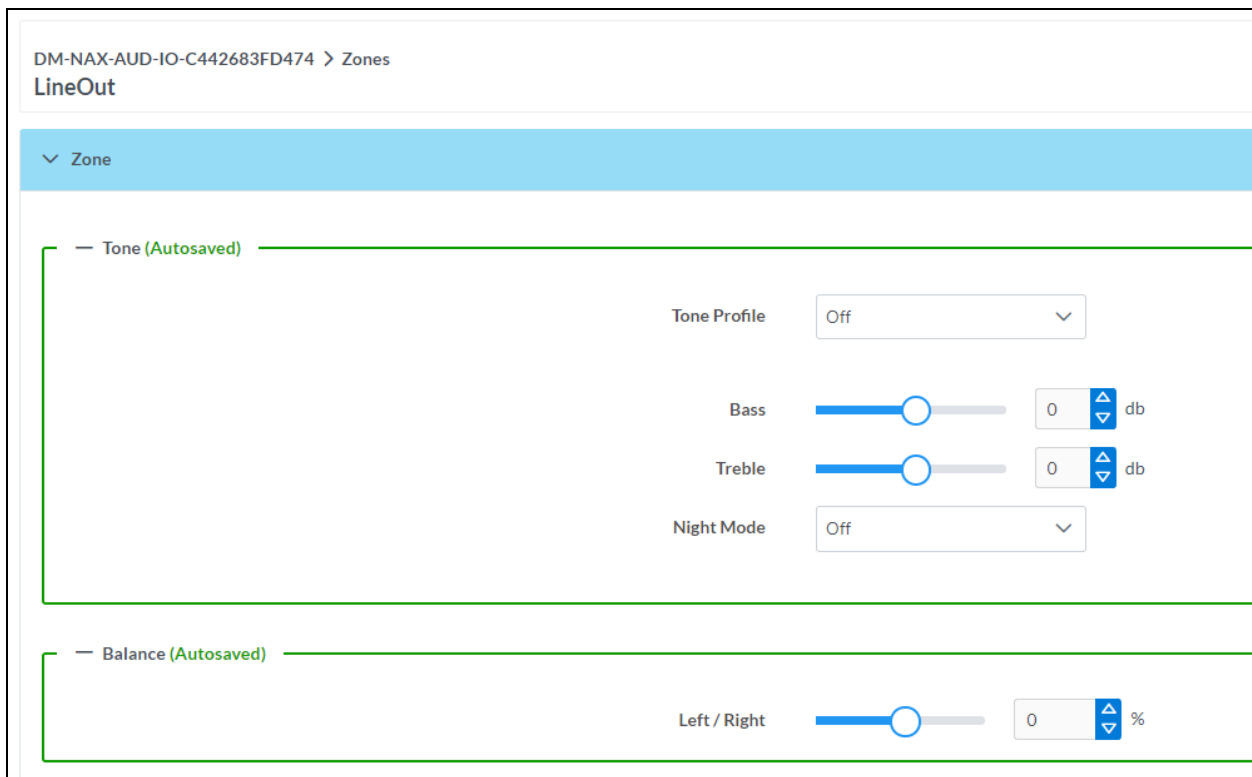

The **Tone** section provides adjustments for the **Tone Profile**, **Bass**, **Treble**, **Loudness**, and **Night Mode** settings of the zone output.

NOTE: The Tone Profile, Bass, Treble, and Loudness settings in the Tone section are all applied separately from the Equalizer Settings for the zone. This means that any adjustments made in the Tone section will stack with those made in the Equalizer Settings section.

1. To select a tone profile preset for the zone, select an option from the **Tone Profile** drop-down menu. The available options are **Off**, **Classical**, **Jazz**, **Pop**, **Rock**, and **Spoken Word**. By default, **Off** is selected.
2. **Bass:** To adjust the bass, do one of the following:
 - Move the **Bass** slider to the right to increase or to the left to decrease the bass.
 - Use the **db** arrows to increase or decrease the bass level. Values range from -12 dB to 12 dB, adjustable in increments of 1 dB.
 - Manually enter a value in the **Bass** field.
3. **Treble:** To adjust the treble, do one of the following:
 - Move the **Treble** slider to the right to increase or to the left to decrease the treble.
 - Use the **db** arrows to increase or decrease the treble level. Values range from -12 dB to 12 dB, adjustable in increments of 1 dB.
 - Manually enter a value in the **Treble** field.
4. To enable the loudness setting on the zone output, slide the **Loudness** switch to the right. To disable loudness, slide the **Loudness** switch to the left.

5. The **Night Mode** feature applies subtle processing to restrict the dynamic range of the zone audio, to allow for lower listening levels at night or in rooms where higher listening levels would be disruptive. To select a dynamics processing level, select an option from the **Night Mode** drop-down menu. The available options are **Off**, **Low**, **Medium**, and **High**. By default, **Off** is selected.

Balance

To adjust the left/right balance of the stereo output signal, do one of the following:

- Move the **Balance** slider to the right to shift the stereo balance to the right channel or to the left to shift the balance to the left.
- Use the arrows to adjust the balance left or right. The up arrow shifts the balance to the right while the down arrow shifts the balance to the left.
- Manually enter a value in the **Balance** field. Values range from -50 to 50, adjustable in increments of 1. Positive values shift the balance to the right while negative values shift the balance to the left.

Delay

To set the delay, do one of the following:

- Move the **Delay Time(ms)** slider to the right to increase or to the left to decrease the delay time.
- Use the **ms** arrows to increase or decrease the delay. Values range from 0 ms to 85 ms, adjustable in increments of 1 ms.
- Manually enter a value in the **Delay Time(ms)** field.

Output

Select **Output** to access the settings for **Minimum/Maximum Volume**, **Stereo/Mono**, **Signal**, **Bussing**, **Volume Offset**, **Signal Generator**, and **Equalizer Settings**.

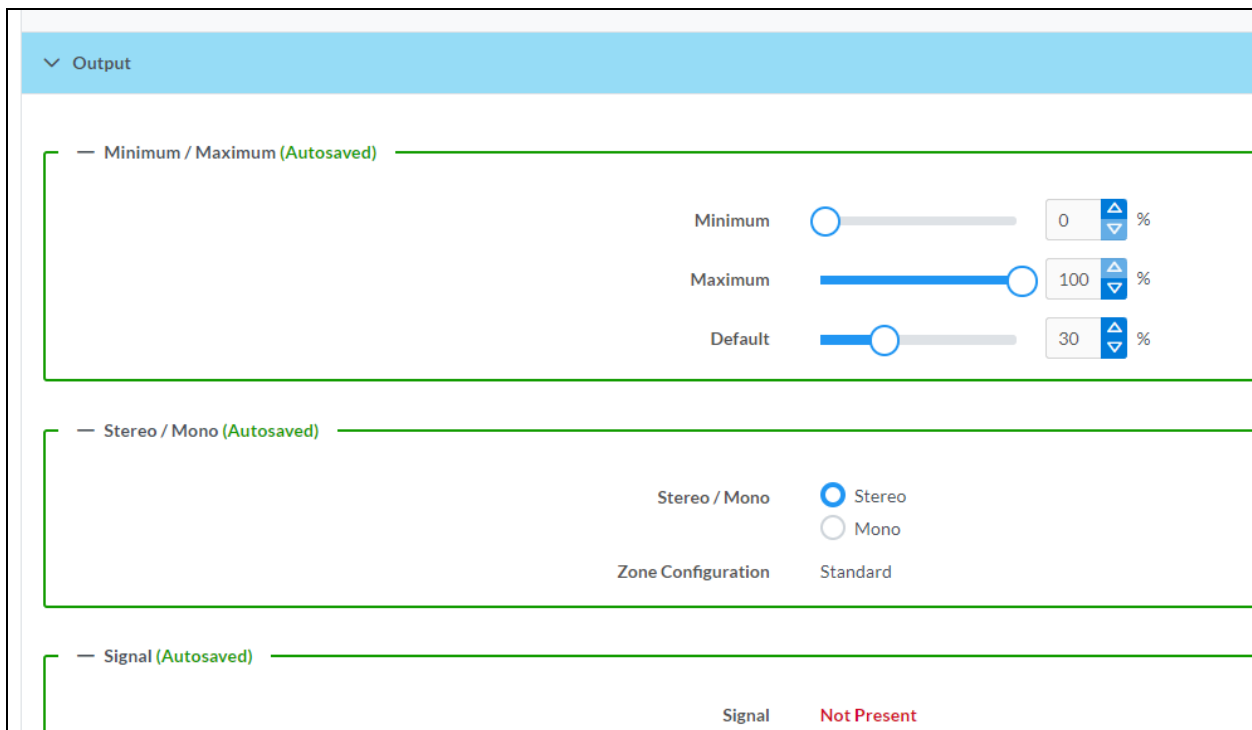

Minimum/Maximum Volume

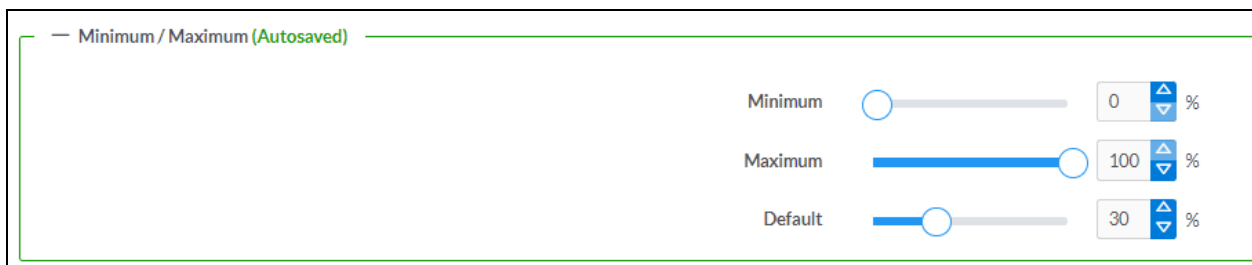

1. To set the minimum volume of the zone, do one of the following:
 - Move the **Minimum** slider to the right to increase or to the left to decrease the minimum volume.
 - Use the **%** arrows to increase or decrease the minimum volume. Values range from 0 to 50%, adjustable in increments of 1%.
 - Manually enter a value in the **Minimum** field.

- To set the maximum volume of the zone, do one of the following:
 - Move the **Maximum** slider to the right to increase or to the left to decrease the maximum volume.
 - Use the **%** arrows to increase or decrease the maximum volume. Values range from 70 to 100%, adjustable in increments of 1%.
 - Manually enter a value in the **Maximum** field.

NOTE: When a **Minimum** and **Maximum** volume are set, the 1-100% range represented by the **Zone** and **Default** volume controls are scaled to the range set. For example, if a **Minimum** of 10% and a **Maximum** of 80% are set for a zone, the 1-100% range of the **Zone** volume control is scaled to the 10%-80% range set as the **Minimum** and **Maximum**.

- To set the default volume of the zone, do one of the following:
 - Move the **Default** slider to the right to increase or to the left to decrease the default volume.
 - Use the **%** arrows to increase or decrease the default volume. Values range from 0 to 50%, adjustable in increments of 1%.
 - Manually enter a value in the **Default** field.

NOTE: The **Default** volume is applied as the **Zone** volume any time the zone receives a source route and no source was previously routed to that zone.

Stereo/Mono

— Stereo / Mono (Autosaved)

Stereo / Mono Stereo
 Mono

Zone Configuration Standard

Select either **Stereo** or **Mono**. If **Stereo** is selected, both output channels can have independent audio content. If **Mono** is selected, both output channels receive the same audio content.

Signal

— Signal (Autosaved)

Signal Not Present
Clipping None

The **Signal** section is a read-only field that displays the **Signal** and **Clipping** status of the zone output.

- If an output signal is present but not clipping, **Signal** will display **Present** in green and **Clipping** will display **None** in green.
- If an output signal is present and clipping, **Signal** will display **Present** in green and **Clipping** will display **Present** in red.
- If no output signal is detected, **Signal** will display **Not Present** in red and **Clipping** will display **None** in green.

Bussing Volume Offset

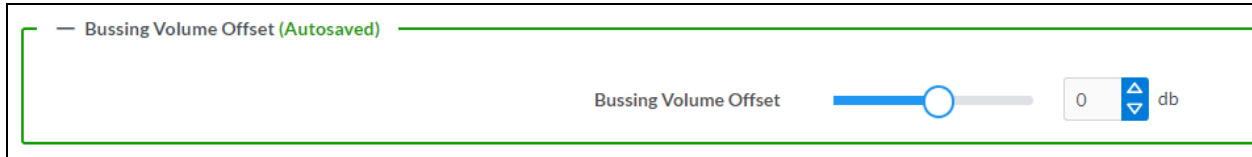

Bussing Volume Offset is an additional level compensation applied to the zone relative to any other zones it is grouped with via the **Bussing** feature.

To set the bussing volume offset, do one of the following:

- Move the **Bussing Volume Offset** slider to the right to increase or to the left to decrease the offset.
- Use the **db** arrows to increase or decrease the offset. Values range from -12 dB to 12 dB, adjustable in increments of 1 dB.
- Manually enter a value in the **Bussing Volume Offset** field.

Signal Generator

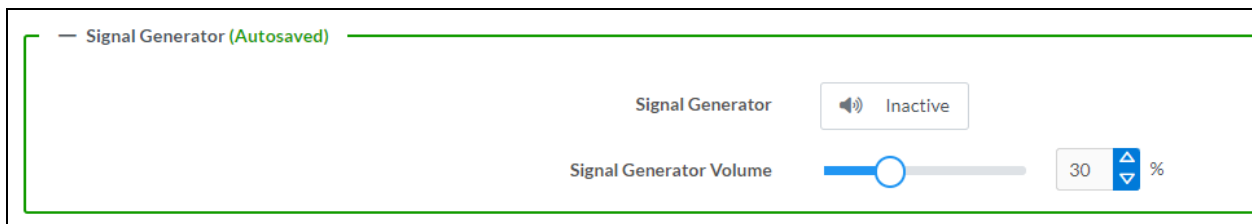

The DM-NAX-AUD-IO has a built-in signal generator that allows an integrator to send an audio signal to the output for testing purposes.

1. To route the signal generator to the zone output, select **Signal Generator** so that it displays **Active** and is highlighted in blue. To unroute the signal generator on the zone output, select **Signal Generator** so that it displays **Inactive** and is highlighted in grey. By default, the signal generator is not routed to the zone output.
2. To adjust the signal generator's volume, do one of the following:
 - Move the **Signal Generator Volume** slider right to increase or left to decrease the volume.
 - Use the arrows to increase or decrease the signal generator volume. Values range from 0 to 100, adjustable in increments of 1.
 - Manually enter a value in the **Signal Generator Volume** field.

Equalizer Settings

Band	Band01	Band02	Band03	Band04	Band05	Band06	Band07	Band08	Band09	Band10
Gain										
Gain Value	0	0	0	0	0	0	0	0	0	0
Type	EQ	EQ	EQ	EQ	EQ	EQ	EQ	EQ	EQ	EQ
Frequency	32	64	125	250	500	1000	2000	4000	8000	16000
Bandwidth	0.33	0.33	0.33	0.33	0.33	0.33	0.33	0.33	0.33	0.33
Bypass	<input type="checkbox"/>	<input type="checkbox"/>	<input type="checkbox"/>	<input type="checkbox"/>	<input type="checkbox"/>	<input type="checkbox"/>	<input type="checkbox"/>	<input type="checkbox"/>	<input type="checkbox"/>	<input type="checkbox"/>
Actions	Reset	Reset	Reset	Reset	Reset	Reset	Reset	Reset	Reset	Reset

The zone output of the DM-NAX-AUD-IO has a dedicated ten-band equalizer that can be fully customized to tune the zone output signal to the needs of an install. Each band can have a discrete gain, filter type, center frequency, and bandwidth set, and can also be bypassed. The equalizer itself can also be bypassed using the **Speaker EQ Enabled** toggle.

1. Set the **Speaker EQ Enabled** toggle to the right position to enable the equalizer. Set the toggle to the left position to bypass the equalizer.

NOTE: When **Speaker EQ Enabled** is disabled, all equalizer bands are bypassed. This is a quick way to perform A/B testing of the entire EQ curve.

2. With the **Speaker EQ Enabled** toggle in the right position, configure the equalizer bands.
 - a. To set a band's gain, do one of the following:
 - Move the **Gain** slider up to increase or down to decrease the gain.
 - Use the arrows to increase or decrease the gain. Values range from -40 dB to 20 dB, adjustable in increments of 0.1 dB.
 - Manually enter a value in the **Gain** field.

- b. Select a filter type from the **Type** drop-down menu. By default, all bands are set to the **EQ** filter type. Some filter types will disable other settings in their respective band while enabled. For example, selecting the **LowPass** filter type for a band will disable that band's **Gain** and **Bandwidth** settings, since the **LowPass** filter applies a fixed roll-off slope at a set frequency. The available filter types are:
- **EQ:** a fully parametric filter that can boost or cut a range of frequencies.
 - **Notch:** a parametric filter designed to more precisely cut a frequency or range of frequencies. A notch filter can achieve a narrower bandwidth than the standard **EQ** parametric filter type.
 - **TrebleShelf:** a filter that boosts or cuts all frequencies above a set frequency by a set gain.
 - **BassShelf:** a filter that boosts or cuts all frequencies below a set frequency by a set gain.
 - **LowPass:** a filter that fully cuts all frequencies above a set frequency using a fixed roll-off slope of -12 dB per octave.
 - **HighPass:** a filter that fully cuts all frequencies below a set frequency using a fixed roll-off slope of -12 dB per octave.
- c. Set a center frequency for the equalizer band to tune a specific portion of the audible frequency spectrum. To set the center frequency, do one of the following:
- Use the arrows to increase or decrease the frequency. Values range from 20 Hz to 20 kHz, adjustable in increments of 1 Hz. Each band has a default center frequency that will be applied if **Reset** at the bottom of the band is selected.
 - Manually enter a value in the **Frequency** field.
- d. Set a bandwidth to determine how wide of a frequency range is effected by the equalizer band. To set the bandwidth, do one of the following:
- Use the arrows to increase or decrease the bandwidth. Values range from 0.1 octaves to 4.0 octaves, adjustable in increments of 0.1 octave.
 - Manually enter a value in the **Bandwidth** field.
- e. The individual Bypass controls allow you to bypass a single band of equalization at a time for more granular A/B testing of a single filter. Set a band's **Bypass** toggle to the right position to bypass that band. Set the toggle to the left position to disable the bypass. By default, **Bypass** is disabled.
- f. Each equalizer band has a **Reset** that will reapply the default settings for that band.

Select **Done** to return to the **Settings** tab of the web user interface.

Inputs

The **Inputs** section is used to configure the **Name**, **Compensation**, and **Mute** attributes of the available analog, digital, and media streaming inputs on the DM-NAX-AUD-IO.

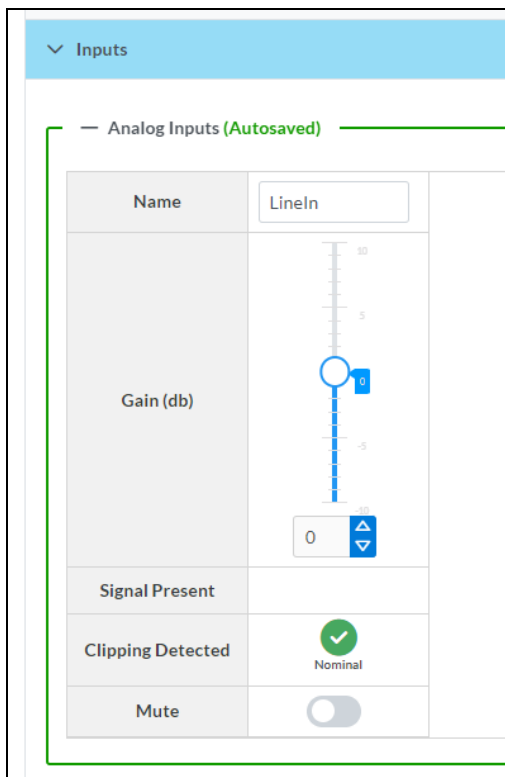

Configure Inputs

1. If needed, enter a friendly name for each input in its **Name** field.
2. To set a level compensation adjustment for a given input, do one of the following:
 - Move the **Compensation** slider up to increase or down to decrease the level compensation. Compensation increases or decreases the level of the incoming audio signal on any of the physical inputs on the device's rear panel.
 - Use the **db** arrows to increase or decrease the compensation. Values range from -10 dB to 10 dB, adjustable in increments of 1 dB.
 - Manually enter a value in the **Compensation** field.
3. To mute the signal from the corresponding input, set the **Mute** toggle to the right. To disable the mute, set the **Mute** toggle to the left. By default, **Mute** is disabled.

Monitor the device's input signals using the text indicators in the **Signal Present** and **Clipping Detected** columns:

- **Signal Presence** indicates whether or not a signal is detected in that zone.
- **Clipping Detected** indicates if the signal is **Clipping** or **Nominal** (non-clipping).

NAX Streams

The two local line level input channels of the DM-NAX-AUD-IO can be made available as a DM NAX audio-over-IP stream.

Select **NAX Streams** to expand the tab and display the following information.

This Device is the Leader PTP Clock Source **No**
 PTP Clock Leader MAC Address 00:1d:c1:12:16:68
 PTP Priority 254

— Transmitters (Autosaved)

Audio Source	Stream	Nax Stream Address	Nax Stream Name	Status	Actions
LineIn	Stream01	239.69.19.1	Stream01-AUD-IO	Stream Started	▶ ⚙

— Receivers (Autosaved)

Zone Name	Stream	Current Stream Address	Requested Stream Address	Status	Actions
LineOut	Stream01	239.69.190.168	239.69.190.168	Stream Started	▶ ⚙

- **Device is Leader PTP Clock Source** indicates whether the device is the leader for PTP on the network. **Yes** will be displayed in green when the local DM-NAX-AUD-IO is the PTP leader clock and **No** will be displayed in red when another PTP clock on the network is operating as the leader clock.
- **Leader Clock Status** displays the Leader Clock ID of the device on the network that acts as the Leader Clock.
- **PTP Priority:** This sets the priority of the local DM NAX device's PTP clock relative to other clocks on the network. The default setting is 254 (one increment higher than the lowest possible value) so that the DM-NAX-AUD-IO will only operate as the leader clock if no other PTP leader is present on the network. Valid values range from 1 to 255.

Configure Transmitters

To configure a DM NAX transmit stream:

1. Enter a valid multicast address in the **NAX Stream Address** field.
2. Enter a name in the **NAX Stream Name** field by which the stream can be identified. This stream name is associated with the DM NAX stream's multicast address by other DM NAX or AES67 devices, like a device hostname that resolves to a given IP address.
3. **Status** indicates whether a stream is transmitting or not. When the stream has started or stopped, the **Status** column will update accordingly.
4. Select the configure icon  in the **Actions** column. The **Configure** dialog appears:

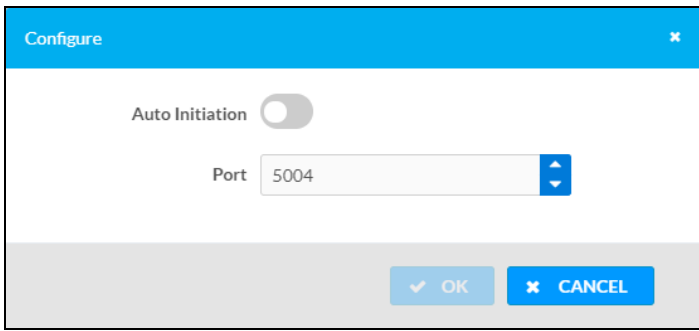

5. Set the **Auto Initiation** toggle to the right position to enable auto initiation. Set the toggle to the left position to disable auto initiation.
 - If **Auto Initiation** is enabled for a given stream, the stream will begin transmitting automatically and will be available as a multicast stream on your network at the specified multicast address.
 - If **Auto Initiation** is disabled for the input, the stream will not begin transmitting until it is manually initiated.
6. To set the port number, do one of the following:
 - Use the arrows to increase or decrease the port number by increments of 1.
 - Manually enter a port number in the **Port** field. The default port number for DM NAX streams is 5004.
7. Select **OK** to save or select **Cancel** to cancel the changes.

Configure Receivers

1. Enter the multicast address of a transmitting stream in the **Requested Stream Address** field to subscribe the receiver to the stream.
2. Select the configure icon  in the **Actions** column. The **Configure** dialog appears:

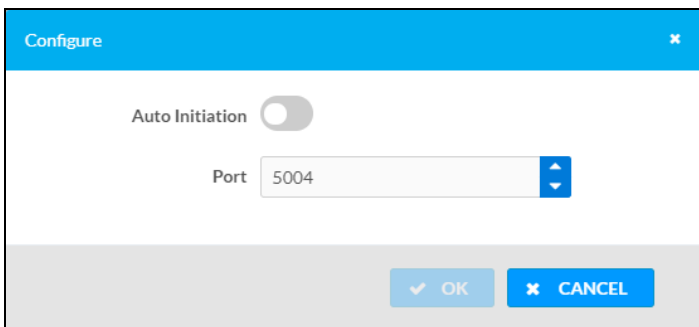

3. Set the **Auto Initiation** toggle to the right position to enable auto initiation. Set the toggle to the left position to disable auto initiation.
 - If **Auto Initiation** is enabled, the stream will begin automatically when the receiver subscribes to the transmitter.
 - If **Auto Initiation** is disabled, the stream will not begin until it is manually initiated.





4. To set the port number, do one of the following:
 - Use the arrows to increase or decrease the port number by increments of 1.
 - Manually enter a port number in the **Port** field. The default port number is 5004.
5. Select **OK** to save or select **Cancel** to cancel the changes.

Routing

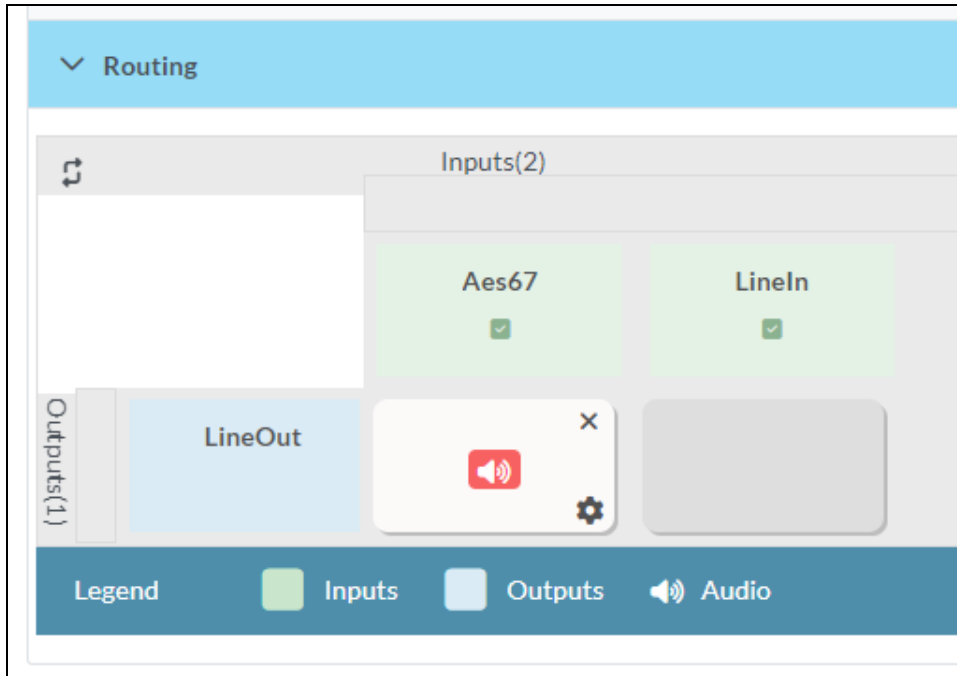
The **Routing** section is used to route a local input or AES67 stream to a Zone on the DM-NAX-AUD-IO.

NOTE: To receive an AES67 stream from Dante devices, see [OLH 1001151](#).



- To route an input to a zone, select the box in the routing matrix where the zone's row overlaps the corresponding input's column. Once a route is made,  appears.
- To break a given route select  or .
- To route a single input to all zones, select the  icon under the input's name.

Security

Select the **Security** tab to configure security for users and groups and to allow different levels of access to the DM-NAX-AUD-IO functions. By default, security is disabled.

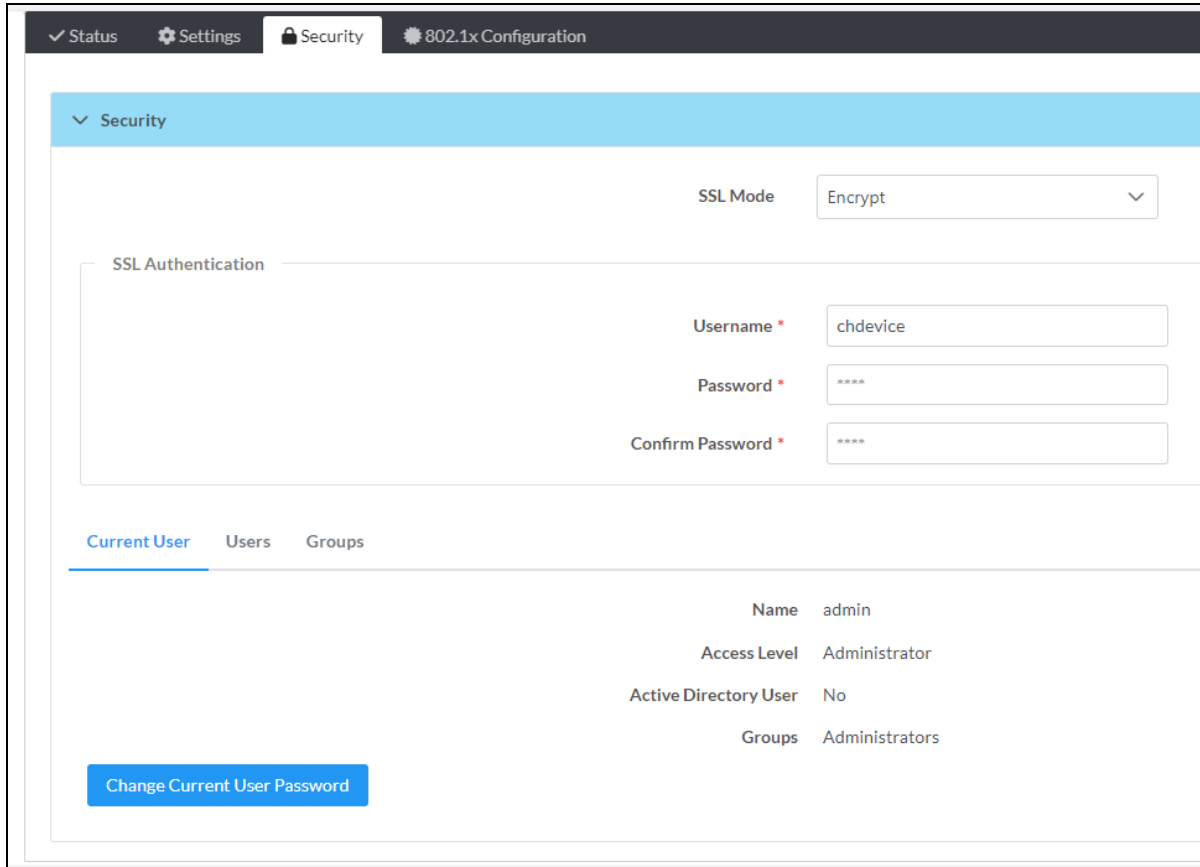

Select **Encrypt and Validate**, **Encrypt**, or **OFF** in the **SSL Mode** drop-down menu, to specify whether to use encryption. By default, SSL Mode is set to **OFF**.

Current User

Select the **Current User** tab to view read-only information or to change the password for the current user.

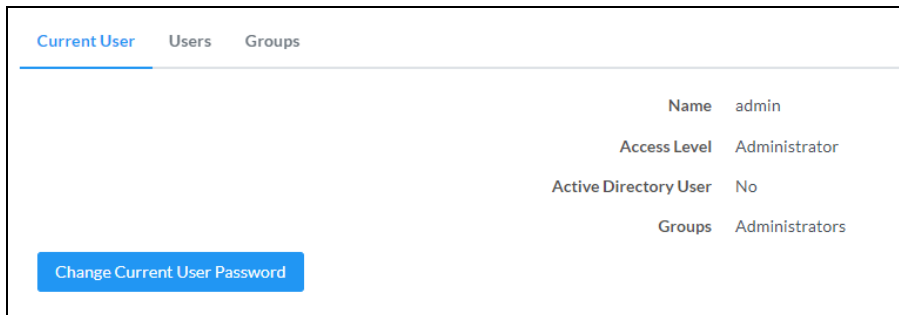

1. Select **Change Current User Password** to provide a new password for the current user.
2. In the **Change Password** dialog, enter the current password in the **Current Password** field, the new password in the **Password** field, and then re-enter the same new password in the **Confirm Password** field.

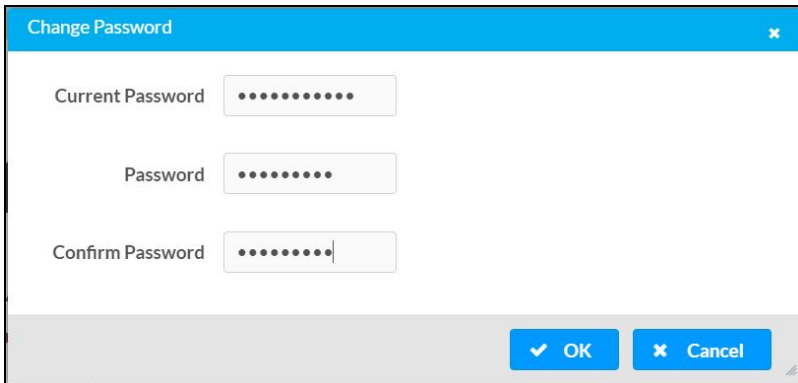

The image shows a 'Change Password' dialog box with a blue header and a close button. It contains three password input fields: 'Current Password', 'Password', and 'Confirm Password'. Each field is filled with dots. At the bottom, there are two buttons: 'OK' with a checkmark icon and 'Cancel' with an 'X' icon.

3. Select **OK** to save or select **Cancel** to cancel the changes.

Users

Select the **Users** tab to view and edit user settings. The **Users** tab can be used to add or remove local and Active Directory users and preview information about users.

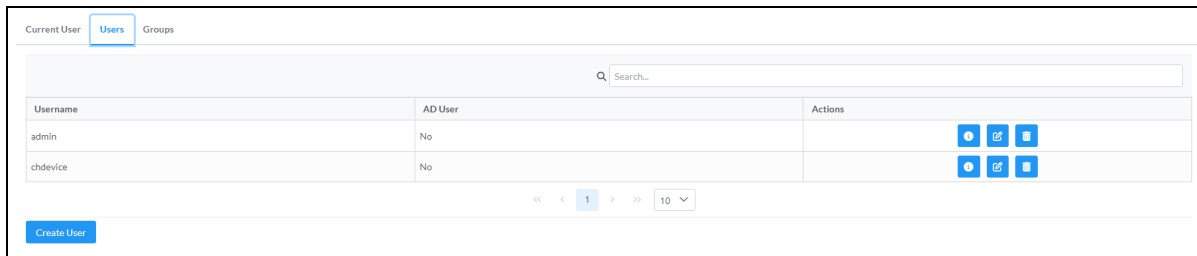

The image shows a web interface for managing users. At the top, there are tabs for 'Current User', 'Users', and 'Groups'. Below the tabs is a search bar labeled 'Search...'. A table lists users with columns for 'Username', 'AD User', and 'Actions'. The table contains two rows: 'admin' and 'chdevice', both with 'AD User' set to 'No'. The 'Actions' column for each row contains three icons: a magnifying glass, a document with a pencil, and a trash can. Below the table is a pagination control showing '1' of 10 items.

Username	AD User	Actions
admin	No	[Icons]
chdevice	No	[Icons]

Use the **Search Users** field to enter search term(s) and display users that match the search criteria.

If users listed in the **Users** table span across multiple pages, navigate through the list of users by selecting a page number or by using the left or right arrows at the bottom of the **Users** pane to move forward or backward through the pages.

Each page can be set to display 5, 10, or 20 users by using the drop-down menu to the right of the navigation arrows.

Information about existing users is displayed in table format and the following details are provided for each user.

- **Username:** Displays the name of the user.
- **AD User:** Displays whether the user requires authentication using Active Directory.

Select the corresponding icon in the Actions column to view detailed user information or to delete the user.

To create a new user, select **Create User**.

Create a New Local User

1. Select **Create User** in the **Users** tab.
2. In the **Create User** dialog, enter the following:

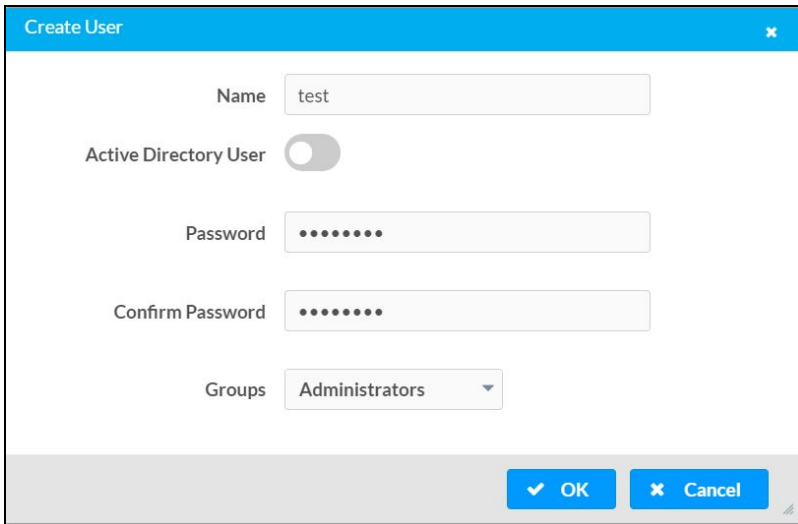

- a. Enter a user name in the **Name** field. A valid user name can consist of alphanumeric characters (letters a-z, A-Z, numbers 0-9) and the underscore "_" character.
- b. Enter a password in the **Password** field; re-enter the same password in the **Confirm Password** field.
- c. Assign the access level by selecting one or more groups from the **Groups** drop-down list.

NOTE: Make sure that the **Active Directory User** toggle is disabled.

3. Select **OK** to save or select **Cancel** to cancel the changes.

Add an Active Directory User

Users cannot be created or removed from the Active Directory server, but access can be granted to an existing user in the Active Directory server.

To grant access to an Active Directory user, you can either add the user to a local group on the DM-NAX-AUD-IO, or add the Active Directory group(s) that they are a member of to the DM-NAX-AUD-IO.

To add an Active Directory user.

1. Select **Create User**.
2. In the **Create User** dialog, enter the following.

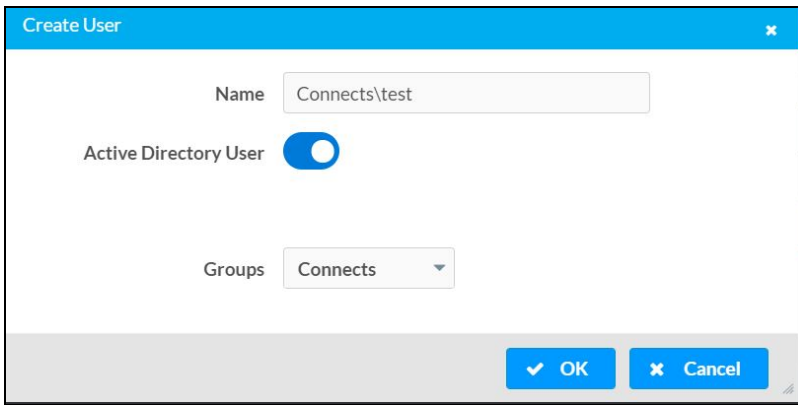

- a. Enter a user name in the **Name** field in the format "Domain\UserName", for example "crestronlabs.com\JohnSmith". Valid user names can contain alphanumeric characters (letters a-z, A-Z, numbers 0-9) and the underscore "_" character.
- b. Select one or more groups from the **Groups** drop-down list.

NOTE: Make sure that the **Active Directory User** toggle is set to enabled.

3. Select **OK** to save or select **Cancel** to cancel the changes.

Delete User

Select the trashcan icon  in the **Actions** column to delete the user. Select **Yes** when prompted to delete the user or **No** to cancel the deletion.

After a user is removed from a group, they lose any access rights associated with that group. Note that the user account is not deleted by the delete user operation.

View User Details

Select the information icon  in the **Actions** column to view information for the selected user. The **User Details** dialog displays the following information for the selected user.

- **Name:** Displays the name of the selected user.
- **Active Directory User:** Displays whether the user is an Active Directory user.
- **Group:** Displays group(s) the selected user is part of.

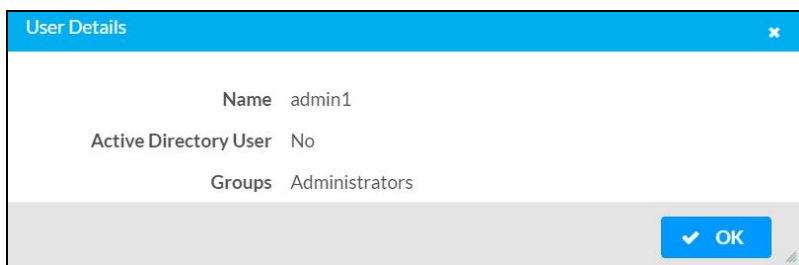

Select **OK** to close the **User Details** dialog and to return to the **Users** tab.

Update User Details

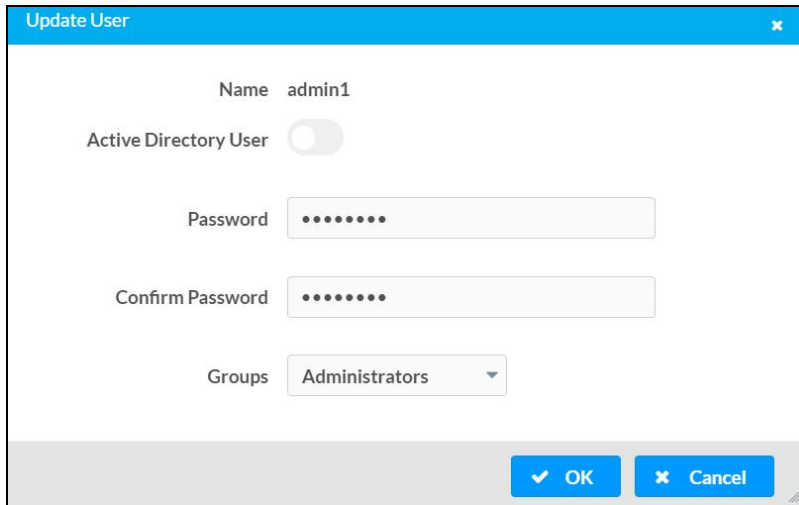

1. Select the edit icon  in the **Actions** column to update information for the selected user.
2. Enter a password in the **Password** field; re-enter the same password in the **Confirm Password** field.
3. Select one or more groups to assign the user to from the **Groups** drop-down list.
4. Select **OK** to save or select **Cancel** to cancel the changes.

The **Update User** dialog also displays the following read-only information for the selected user.









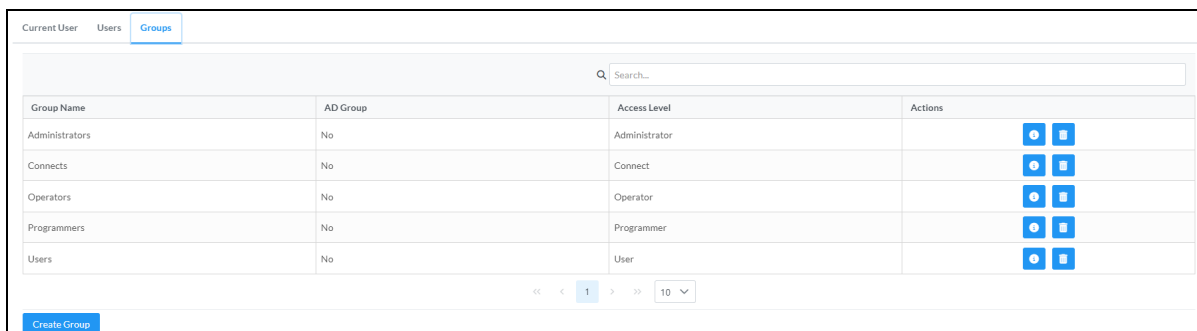

- **Name:** Displays the name of the user.
- **Active Directory User:** Displays whether the user is an Active Directory user.

Groups

Select the **Groups** tab to view and edit group settings. The **Groups** tab can be used to add local and Active Directory groups, remove local and Active Directory groups, and preview information about a group.

Use the **Search Groups** field to enter search term(s) and display groups that match the search criteria.





Group Name	AD Group	Access Level	Actions
Administrators	No	Administrator	 
Connects	No	Connect	 
Operators	No	Operator	 
Programmers	No	Programmer	 
Users	No	User	 

If groups listed in the **Groups** table span across multiple pages, navigate through the groups by selecting a page number or by using the left or right arrows at the bottom of the **Groups** pane to move forward or backward through the pages.

Additionally, each page can be set to display 5, 10, or 20 groups by using the drop-down menu to the right of the navigation arrows.

Existing groups are displayed in a table and the following information is provided for each group:

- **Group Name:** Displays the name of the group.
- **AD Group:** Displays whether the group requires authentication using Active Directory.
- **Access Level:** Displays the predefined access level assigned to the group (Administrator, Programmer, Operator, User, or Connect).

Select the corresponding icon in the **Actions** column to view detailed group information  or to delete  selected group.

Select **Create Group** in the **Groups** tab to create new group.

Create Local Group

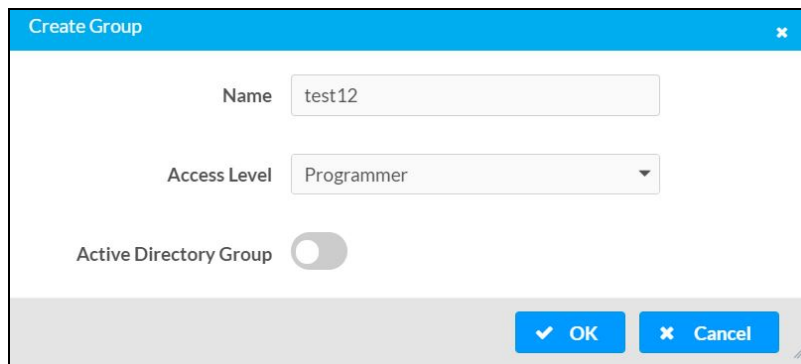

1. Select **Create Group**.
2. In the **Create Group** dialog, enter the following:
 - a. Enter the group name in the **Name** field.
 - b. Assign the group access level by selecting a predefined access level (Administrator, Connect, Operator, Programmer, User) from the **Access Level** drop-down list.

NOTE: Make sure that the **Active Directory Group** toggle is disabled.

3. Select **OK** to save. Select **Cancel** to cancel the changes.

Add Active Directory Group

A group cannot be created or removed from the Active Directory server, but access can be granted to an existing group in Active Directory.

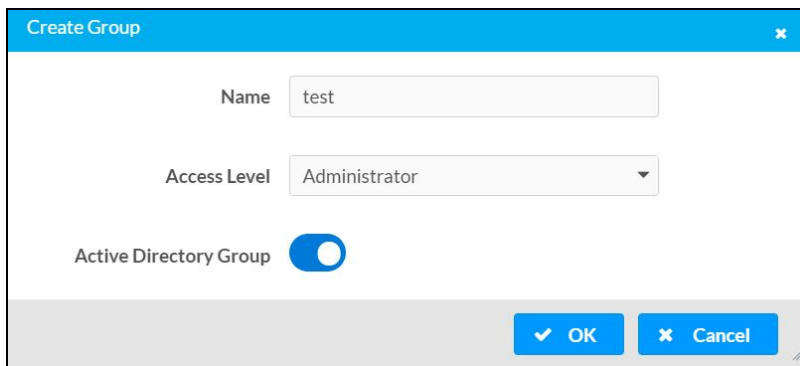

Once the group is added, all members of that group will have access to the DM-NAX-AUD-IO.

1. Select **Create Group**.
2. In the **Create Group** dialog enter the following:
 - a. Enter the group name in the **Name** field, for example "Engineering Group". Note that group names are case sensitive; a space is a valid character that can be used in group names.
3. Assign the group access level by selecting a predefined access level (Administrator, Connect, Operator, Programmer, User) from the **Access Level** drop-down list.

NOTE: Make sure that the **Active Directory Group** toggle is enabled.

4. Select **OK** to save. Select **Cancel** to cancel the changes.

Delete a Group

Select the trashcan icon  in the **Actions** column to delete a group. Select **Yes** when prompted to delete the group or **No** to cancel the deletion.

When a group is deleted, users in the group are not removed from the device or Active Directory server. However, because a user's access level is inherited from a group(s), users within the deleted group will lose access rights associated with the group.

View Group Details

Select the information icon  in the **Actions** column to view information for the selected group. The **Group Details** dialog lists the following information for the selected group.

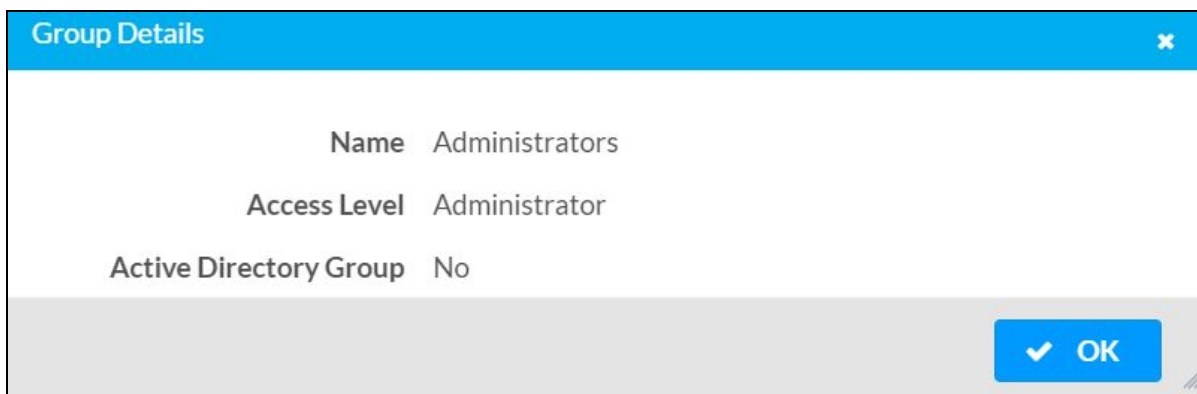

- **Name:** Displays the name of the group.
- **Access Level:** Displays the access level of the group and its users.
- **Active Directory Group:** Displays whether the group is an Active Directory group.

Select **OK** to close the **Group Details** dialog and to return to the **Groups** tab.

802.1x Configuration

The DM-NAX-AUD-IO has built-in support for the 802.1X standard (an IEEE network standard designed to enhance the security of wireless and Ethernet LANs. The standard relies on the exchange of messages between the device and the network's host, or authentication server), allowing communication with the authentication server and access to protected corporate networks.

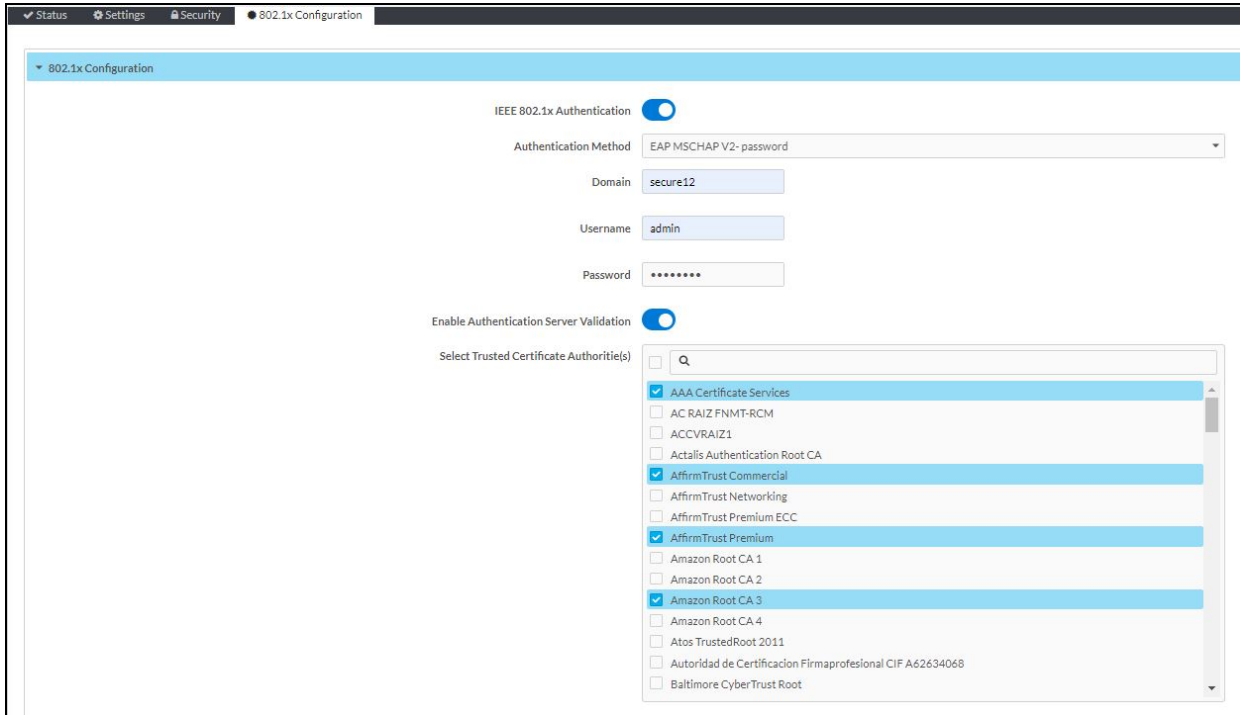

Configure DM-NAX-AUD-IO for 802.1X Authentication

1. Set the **IEEE 802.1X Authentication** toggle to enabled. This will enable all options on the 802.1X dialog.
2. Select the **Authentication method: EAP-TLS Certificate** or **EAP-MSCHAP V2 Password** according to the network administrator's requirement.
3. Do either one of the following:
 - Select **EAP-TLS Certificate**: Select **Action/Manage Certificates** to upload the required machine certificate. The machine certificate is an encrypted file that will be supplied by the network administrator, along with the certificate password.
 - Select **EAP-MSCHAP V2 Password**: Enter the username and password supplied by the network administrator into the **Username** and **Password** fields. This method does not require the use of a machine certificate, only the user name and password credentials.

4. If you enabled the **Enable Authentication Server Validation** option, this will enable the **Select Trusted Certificate Authority(ies)** list box which contains signed Trusted Certificate Authorities (CAs) preloaded into the DM-NAX-AUD-IO.

Select the check box next to each CA whose certificate can be used for server validation, as specified by the network administrator.

If the network does not use any of the listed certificates, the network administrator must provide a certificate, which must be uploaded manually via the **Manage Certificates** functionality.

5. If required, type the domain name of the network in the **Domain** field.
6. When the 802.1X settings are configured as desired, select **Save Changes** to save the changes to the device and reboot it. Select **Revert** to cancel any changes.

DM-NAX-AUD-USB

This section describes how to configure the DM-NAX-AUD-USB.

Web Interface Configuration

The DM-NAX-2XLRI-1G web interface allows you to view status information and configure network and device settings.

Access the Web Interface

To access the web interface, do either of the following:

- [Access the Web Interface with a Web Browser on page 511](#)
- [Access the Web Interface With the Crestron Toolbox™ Application on page 513](#)

The web interface is accessed from a web browser. The following table lists operating systems and their corresponding supported web browsers.

Operating System and Supported Web Browsers

OPERATING SYSTEM	SUPPORTED WEB BROWSERS
Windows® operating system	Chrome™ web browser, version 31 and later Firefox® web browser, version 31 and later Internet Explorer web browser, version 11 and later Microsoft Edge web browser
macOS® operating system	Safari® web browser, version 6 and later Chrome web browser, version 31 and later Firefox web browser, version 31 and later

Access the Web Interface with a Web Browser

1. Enter the IP address of the DM-NAX-AUD-USB into a web browser.

NOTE: To obtain the IP address, use the **Device Discovery Tool** option in Crestron Toolbox™ application or an IP scanner application.

2. If you are creating a user account for the first time, do the following; otherwise, skip to step 3.
 - a. Enter a username in the **Username** field.
 - b. Enter a password in the **Password** field.
 - c. Re-enter the same password in the **Confirm Password** field.

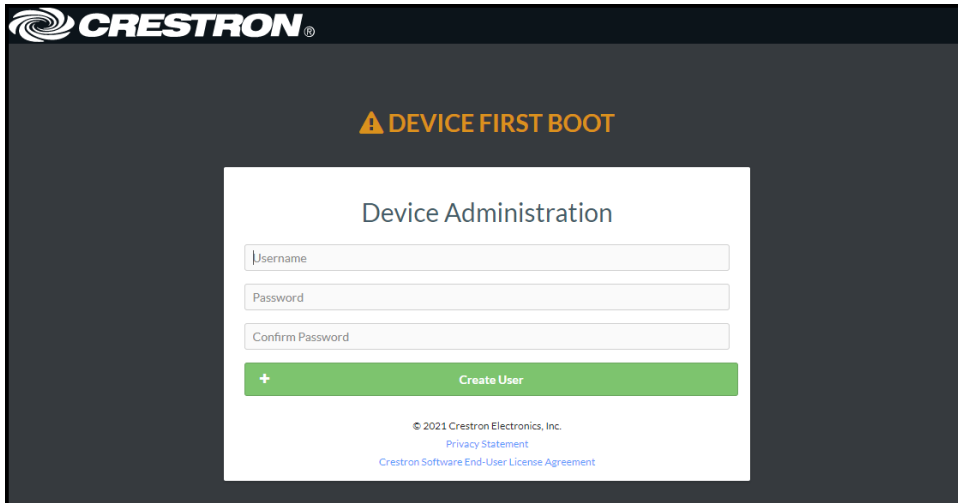

The screenshot shows the Crestron logo at the top left. Below it, a warning icon and the text "DEVICE FIRST BOOT" are displayed. The main content area is titled "Device Administration" and contains three input fields: "Username", "Password", and "Confirm Password". Below these fields is a green button with a plus sign and the text "Create User". At the bottom of the form, there is copyright information: "© 2021 Crestron Electronics, Inc.", a link for "Privacy Statement", and a link for "Crestron Software End-User License Agreement".

- d. Select **Create User**. The Device Administration page appears.

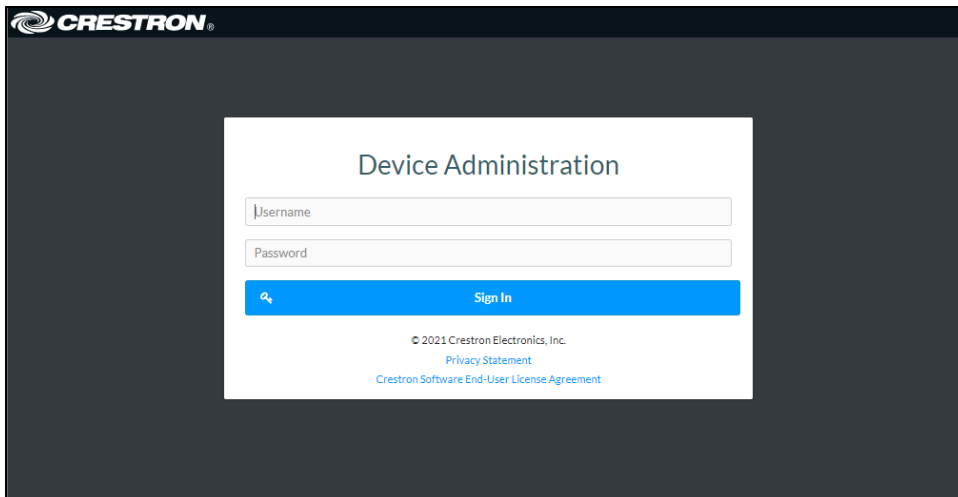

The screenshot shows the Crestron logo at the top left. Below it, the text "DEVICE FIRST BOOT" is no longer visible. The main content area is titled "Device Administration" and contains two input fields: "Username" and "Password". Below these fields is a blue button with a magnifying glass icon and the text "Sign In". At the bottom of the form, there is copyright information: "© 2021 Crestron Electronics, Inc.", a link for "Privacy Statement", and a link for "Crestron Software End-User License Agreement".

3. Enter the username in the **Username** field.
4. Enter the password in the **Password** field.
5. Select **Sign In**.

Access the Web Interface With the Crestron Toolbox™ Application

To access the web interface by opening a web browser within the Crestron Toolbox™ application:

1. Open the Crestron Toolbox application.
2. From the **Tools** menu, select **Device Discovery Tool**. You can also access the Device Discovery Tool by selecting the Device Discovery Tool icon  in the Crestron Toolbox toolbar. The DM-NAX-AUD-USB is discovered and listed in the device list on the left side of the screen. The associated host name, IP address, and firmware version are also displayed.

NOTE: If there is security software running on the computer, a security alert might be displayed when the Crestron Toolbox application attempts to connect to the network. Make sure to allow the connection, so that the Device Discovery Tool can be used.

3. In the Device Discovery Tool list, select the device.
4. Enter the device credentials in the **Authentication Required** dialog that opens, then select **Log In**.
5. Select **Web Configuration**.

Action

The **Action** drop-down menu is displayed at the top right side of the interface and provides quick access to common device functions:

- [Save Changes on page 514](#)
- [Revert on page 514](#)
- [Reboot on page 515](#)
- [Restore to Factory Default Settings on page 515](#)
- [Update Firmware on page 515](#)
- [Download Logs on page 516](#)
- [Manage Certificates on page 516](#)

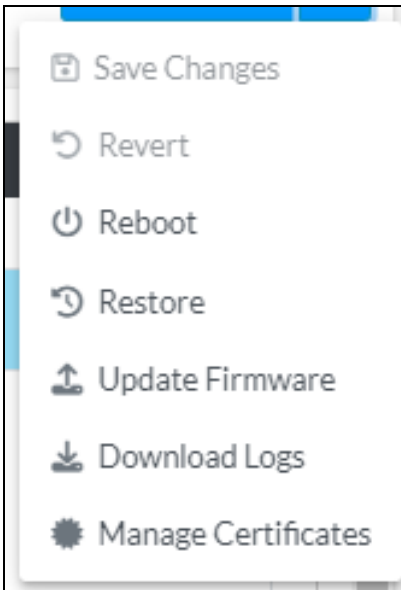

Save Changes

Select **Save Changes** to save any changes made to the configuration settings.

Revert

Select **Revert** to revert the device back to the last saved configuration settings.

Reboot

Certain changes to the settings may require the DM-NAX-AUD-USB to be rebooted to take effect. To reboot the device:

1. Select **Reboot** in the **Action** drop-down menu. The **Confirmation** message box appears.

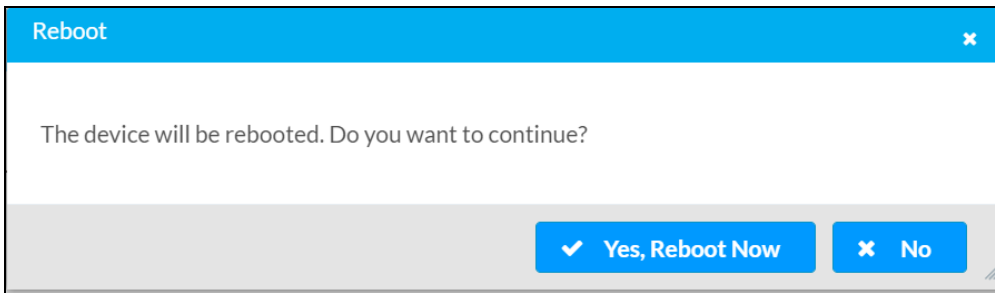

2. Select **Yes, Reboot Now** to reboot the device. The **Reboot** message box appears. Wait for the device reboot to complete before attempting to reconnect to the device.

Restore to Factory Default Settings

1. Select **Restore** in the **Action** drop-down menu to restore the settings of the DM-NAX-AUD-USB to factory defaults.

NOTE: When settings are restored, all settings, including the network settings, will revert to the factory default. If a static IP address is set, restoring the device to factory default settings will revert the IP address to the default DHCP mode.

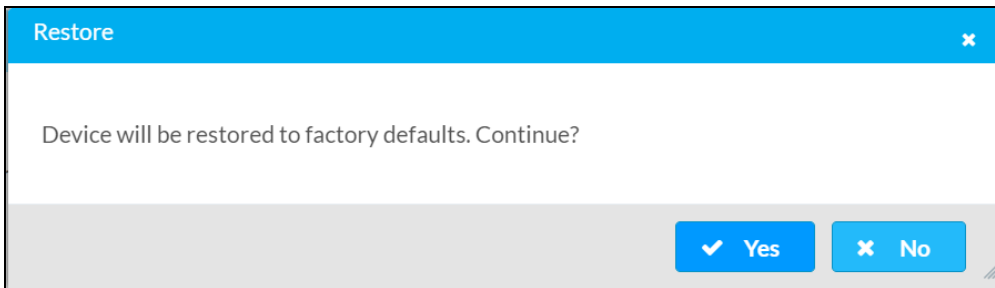

2. Select **Yes** in the **Confirmation** dialog to restore the DM-NAX-AUD-USB to factory settings. Select **No** to cancel the restore operation.

A dialog is displayed again, indicating that the restore process was successful and that the device rebooted.

You can also restore to factory settings by pressing and holding the **SETUP** button on the rear panel of the device with power disconnected then connect the power supply and continue to hold **SETUP** button for 30 seconds.

Update Firmware

1. Select **Update Firmware** in the **Action** drop-down menu.
2. In the **Firmware Upgrade** dialog, select **+ Browse**.

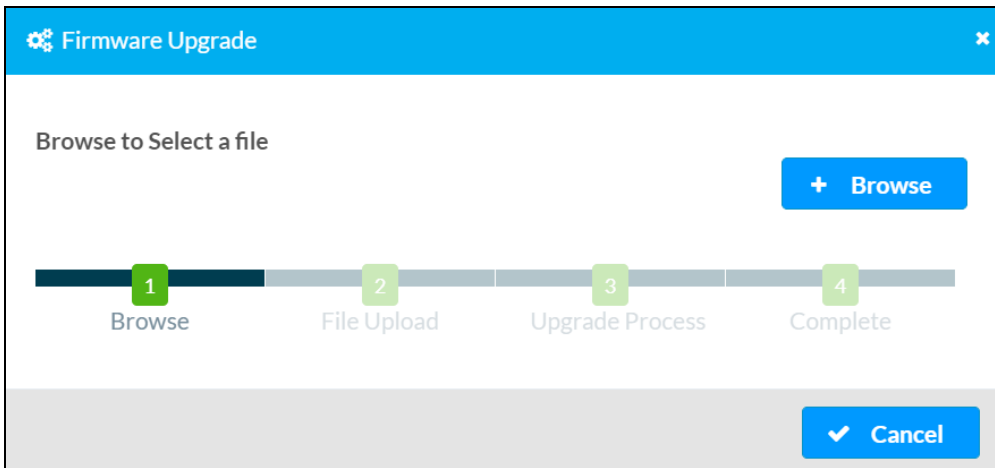

3. Locate and select the desired firmware file, and then select **Open**. The selected firmware file name is displayed in the **Firmware Upgrade** dialog.
4. Select **Load** and wait for the progress bar to complete and for **OK** to become selectable.
5. Select **OK**. The device with new firmware can now be accessed.

Download Logs

Select **Download Logs** in the **Action** drop-down menu to download the device message logs for diagnostic purposes.

The log file is downloaded to the Downloads folder of the PC.

Manage Certificates

Use the **Manage Certificates** dialog to add, remove, and manage certificates used in 802.1x and other protected networks.

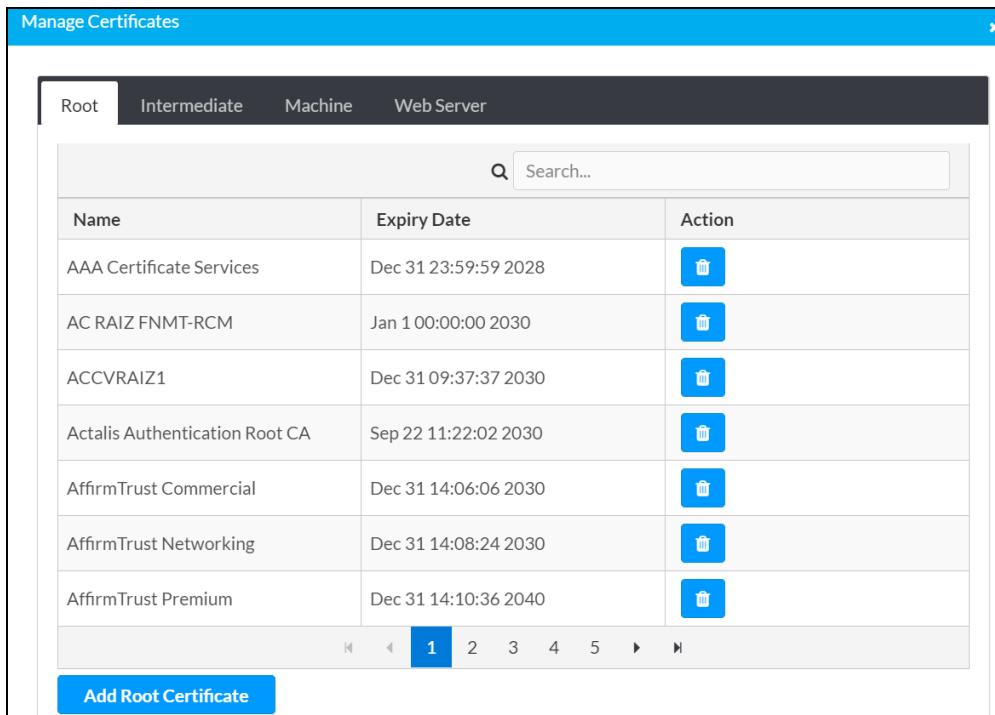

Select **Manage Certificates** in the **Action** drop-down menu. The following certificate tabs are displayed:

- **Root:** The Root certificate is used by the DM-NAX-AUD-USB to validate the network's authentication server. The DM-NAX-AUD-USB has a variety of Root certificates, self-signed by trusted CAs (Certificate Authorities) preloaded into the device. Root certificates must be self-signed.
- **Intermediate:** The Intermediate store holds non self-signed certificates that are used to validate the authentication server. These certificates will be provided by the network administrator if the network does not use self-signed Root certificates.
- **Machine:** The machine certificate is an encrypted PFX file that is used by the authentication server to validate the identity of the DM-NAX-AUD-USB. The machine certificate will be provided by the network administrator, along with the certificate password. For 802.1x, only one machine certificate can reside on the device.
- **Web Server:** The Web Server certificate is a digital file that contains information about the identity of the web server.

To Add Certificates

1. Select the corresponding certificate tab.
2. Select **Add Root Certificate**.
3. Select **+ Browse**.
4. Locate and select the file, then select **Open**.

NOTE: If the certificate is a Machine Certificate, enter the password provided by the network administrator.

5. Select **OK**. This will add the certificate to the list box, displaying the file name and expiration date. The certificate is now available for selection and can be loaded to the device.

To Delete Certificates

1. Select the corresponding certificate tab.
2. Select the trashcan icon  in the **Actions** column to delete the certificate.
3. Select **Yes** when prompted to delete the certificate or **No** to cancel the deletion.

Status

The **Status** page is the first page displayed when opening the interface of the DM-NAX-AUD-USB. It displays general information about the DM-NAX-AUD-USB (such as **Model Name**, **Firmware Version**, and **Serial Number**), current network settings (such as **Host Name** and **IP Address**, etc.), and input and output ports' current status.

The **Status** page can be accessed at any time by selecting the **Status** tab of the DM-NAX-AUD-USB interface.

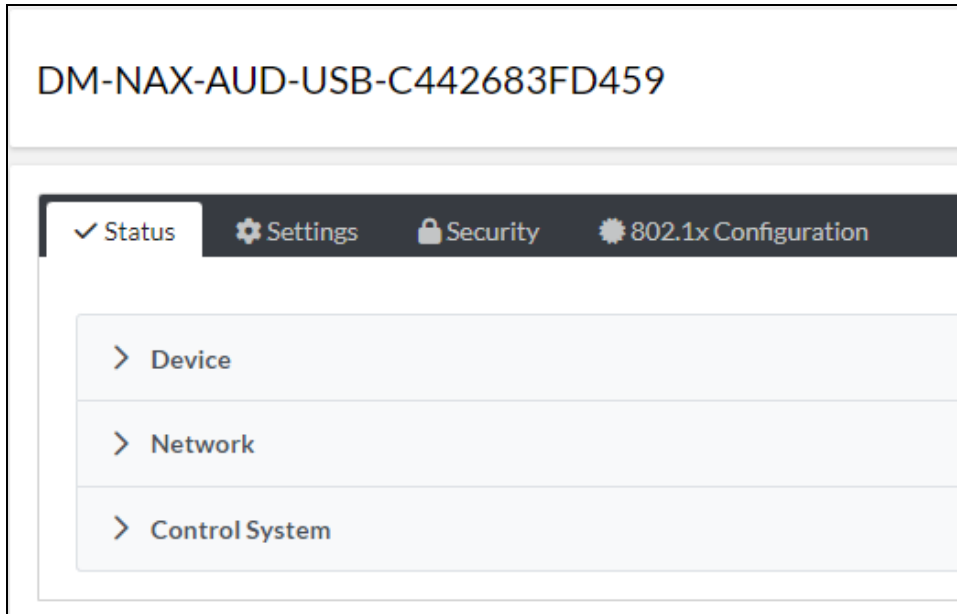

Information displayed on the **Status** tab is organized into different sections.

Device

The **Device** section displays the **Model**, **Firmware Version**, and **Serial Number** of the DM-NAX-AUD-USB.

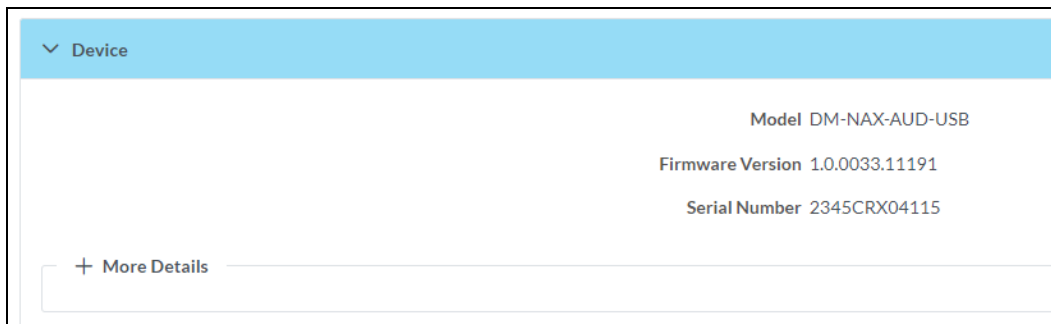

Select **+ More Details** to review additional information about the DM-NAX-AUD-USB.

— More Details

DM-NAX-AUD-USB	1.0.0033.11191
Build	Feb 13 2024 (531246)
Updater	1.0.0033.11191
Bootloader	1.00.00
CCUI Version	1.1327.1
XIOSDK	3.8.2
IoTSDK	1.11.0
Build time	11:19:07
Product ID	0x7A0A
Revision ID	0x0100

HDCP2X-SKE

HDCP2X-SKE	HDCP2X-SKE [v9.0000.00000,#FFFFFFFF]
PRE-BOOT	[v9.0000.00000]
BOOTLOADER	[v9.0000.00000]
ctrl-audio-dsp-0	FW v11 (Driver v4.00)
ctrl-extclk-in-pps	Driver v1.1
ctrl-prod-info	Driver v3.0
PUF	1.0.0033.11191
Eng Debug Mode	True
Forced Auth Mode	True

Network

The **Network** section displays network-related information about the DM-NAX-AUD-USB, including the Hostname, Domain Name, and DNS Servers.

∨ Network

Hostname	DM-NAX-AUD-USB-C442683FD459
Domain Name	CRESTRON.CRESTRON.com
DNS Servers	10.64.5.10(DHCP)

— Adapter 1

DHCP	On
IP Address	10.64.68.176
Subnet Mask	255.255.255.0
Default Gateway	10.64.68.1
Link Active	true
MAC Address	c4.42.68.3f.d4.59

NOTE: By default, the host name of the DM-NAX-AUD-USB consists of the model name followed by the MAC address of the device. For example, DM-NAX-AUD-USB-00107FB58088.

Select **+ Adapter 1** to display an expanded section that shows additional information. If **+ Adapter 1** is selected, select **- Adapter 1** details to collapse the section.

Control System

The **Control System** section displays connection information, consisting of the following:

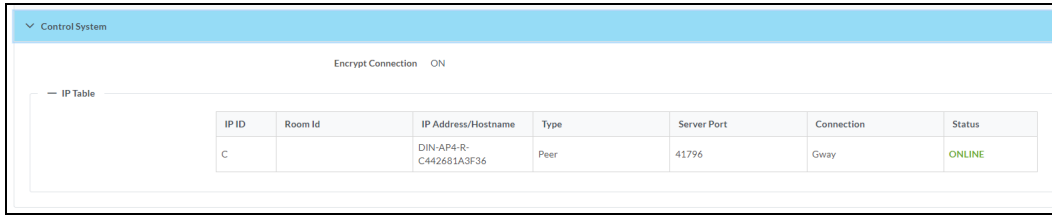

The screenshot shows a web interface for the Control System. At the top, there is a blue header with a dropdown arrow and the text "Control System". Below the header, there is a toggle switch for "Encrypt Connection" which is currently set to "ON". Underneath, there is a section titled "IP Table" which contains a table with the following data:

IP ID	Room Id	IP Address/Hostname	Type	Server Port	Connection	Status
C		DIN-AP4-R- C442681A3F36	Peer	41796	Gway	ONLINE

- **Encrypt Connection:** ON or OFF
- **IP ID:** Reports the currently used IP ID of the DM-NAX-AUD-USB
- **IP Address/Hostname:** The IP address of the control system
- **Room ID:** Displays the room ID
- **Status:** OFFLINE or ONLINE

Settings

The **Settings** page enables configuration of the DM-NAX-AUD-USB settings. The **Settings** page can be accessed at any time by selecting the **Settings** tab of the DM-NAX-AUD-USB interface.

Many options in the **Settings** page are exclusive to a specific device mode: Residential or Commercial. The DM-NAX-AUD-USB is in Commercial mode by default.

This section provides the following information:

- [Commercial Mode on page 522](#)
- [Residential Mode on page 541](#)

Commercial Mode

The **Settings** page enables you to configure the DM-NAX-AUD-USB settings. The **Settings** page can be accessed at any time by selecting the **Settings** tab of the DM-NAX-AUD-USB interface.

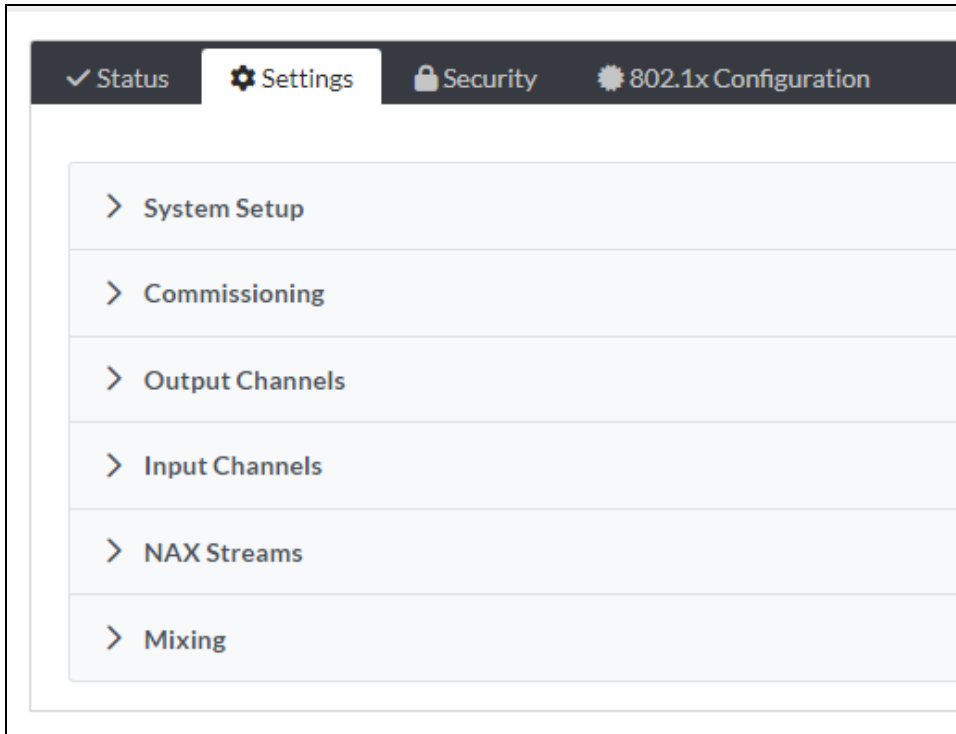

Settings available on the **Settings** page are organized into different sections.

System Setup

The **System Setup** section contains settings for **Date/Time**, **Auto Update**, **Network**, and **Control System**.

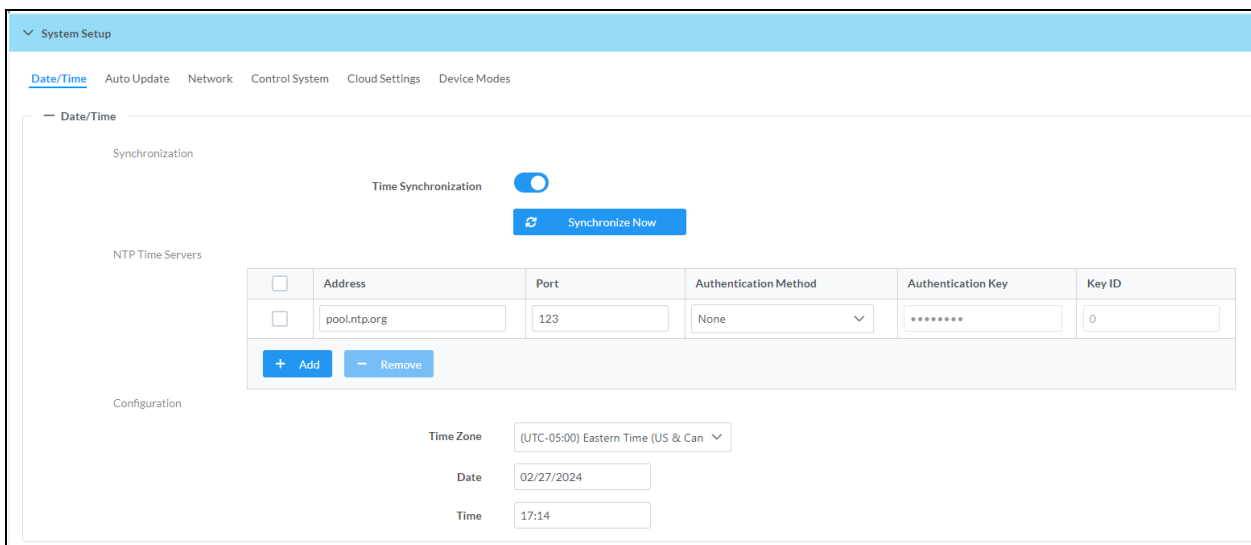

Date/Time

Use the **Date/Time** tab to configure the date and time settings of the DM-NAX-AUD-USB.

— Date/Time

Synchronization

Time Synchronization

 Synchronize Now

NTP Time Servers

<input type="checkbox"/>	Address	Port	Authentication Method	Authentication Key	Key ID
<input type="checkbox"/>	pool.ntp.org	123	None	*****	0

Configuration

Time Zone: (UTC-05:00) Eastern Time (US & Can) ▾

Date: 02/21/2024

Time: 12:40

Time Synchronization

1. Set the **Time Synchronization** toggle to the right position to enable or left position to disable time synchronization. By default, time synchronization is enabled.
2. In the **NTP Time Servers** table, enter the URL of a NTP (Network Time Protocol) or SNTP (Simple Network Time Protocol) server. Up to three time servers can be added on a device.
3. Select **Synchronize Now** to perform time synchronization between the device's internal clock and the time server.

Time Configuration

1. Open the **Time Zone** drop-down menu to select the applicable time zone.
2. In the **Date** field, enter the current date.
3. In the **Time (24hr Format)** field, enter the current time in 24-hour format.

Select **Save Changes** to save the settings.

Select **Revert** from the **Action** drop-down menu to revert to the previous settings without saving.

Auto Update

The DM-NAX-AUD-USB can automatically check for and install firmware updates at scheduled intervals via the **Auto Update** feature.

The screenshot shows the 'Auto Update' configuration interface. It includes the following elements:

- Auto Update:** A toggle switch that is currently turned on (to the right).
- Custom URL:** A toggle switch that is currently turned off (to the left).
- Custom URL Path:** A text input field containing the URL `https://crestrondevicefiles.blob.core.win`.
- Day of Week:** A dropdown menu currently set to 'Daily'.
- Time of Day:** A text input field containing '02:07'.
- Poll Interval:** A text input field containing '0', followed by the label 'Minutes'.
- Update Now:** A blue button located at the bottom of the configuration area.

1. Set the **Auto Update** toggle to the right position to enable Auto Update.
2. Define the URL to download the updates by doing either of the following:
 - a. Use the default URL to download the updates from the Crestron server.
 - b. Use a custom URL. Set the **Custom URL** toggle to the right position to enable a custom URL. In the **Custom URL Path** text box, enter the path to a custom manifest file in the FTP or SFTP URL format. Use the Crestron Auto Update Tool to generate a custom manifest file, then store the file on an FTP (File Transfer Protocol) or SFTP (Secure File Transfer Protocol) server.
3. Set a schedule for the automatic firmware update by doing either of the following:
 - a. Select the desired **Day of Week** and **Time of Day** (24-hour format) values.
 - b. Set the **Poll Interval** by entering a value from **60** to **65535** minutes. A value of **0** disables the Poll Interval.
4. Select **Save Changes**.

Selecting **Update Now** causes the device to check for a firmware update immediately. If a schedule was set in step 4 above, that schedule still remains in effect.

Network

The **Network** tab contains network-related settings for the DM-NAX-AUD-USB, including the Hostname, Domain, Primary Static DNS, and Secondary Static DNS.

System Setup

Date/Time Auto Update **Network** Control System Cloud Settings Device Modes

Network

Adapter 1

Hostname * DM-NAX-AUD-USB-C442683FD459

Domain CRESTRON.CRESTRON.com

Primary Static DNS 10.64.5.10(DHCP)

Secondary Static DNS 192.168.200.133(DHCP)

DHCP Enabled

IP Address 10.64.68.176

Subnet Mask 255.255.255.0

Default Gateway 10.64.68.1

NOTE: By default, the hostname of the DM-NAX-AUD-USB consists of the model name followed by the MAC address of the device. For example, DM-NAX-AUD-USB-00107FB58088.

Adapter 1

The Adapter 1 subheading contains settings for DHCP, IP Address, Subnet Mask, and Default Gateway of Ethernet adapter 1 on the rear panel of the device.

NOTE: DM NAX devices' internal processes use IP addresses in the 10.10.10.xxx range. This IP range should be avoided when addressing DM NAX devices to prevent conflicts.

Set the **DHCP** toggle to enabled (right) or disabled (left) to specify whether the IP address of the DM-NAX-AUD-USB is to be assigned by a DHCP (Dynamic Host Configuration Protocol) server.

- **Enabled:** When **DHCP** is enabled (default setting), the IP address of the DM-NAX-AUD-USB is automatically assigned by a DHCP server on the local area network (LAN).
- **Disabled:** When **DHCP** is disabled, manually enter information in the following fields:
 - **Primary Static DNS:** Enter a primary DNS IP address.
 - **Secondary Static DNS:** Enter a secondary DNS IP address.
 - **IP Address:** Enter a unique IP address for the DM-NAX-AUD-USB.
 - **Subnet Mask:** Enter the subnet mask that is set on the network.
 - **Default Gateway:** Enter the IP address that is to be used as the network's gateway.

To save any new network entries, select **Save Changes**.

Control System

IP ID	IP Address/Hostname	Room Id
C	DIN-AP4-R-C442681A3F36	Room Id

1. Select **Encrypt Connection** to navigate to the **Security** tab to configure encryption settings.
 - a. Enter the username in the **Control System Username** field.
 - b. Enter the password in the **Control System Password** field.
2. Select **+ Add** to add an IP table entry to the **IP Table**.
 - a. Enter the Room ID in the **Room ID** field.
 - b. Enter the IP ID of the DM-NAX-AUD-USB in the **IP ID** field.
 - c. Enter the IP address or hostname of the control system in the **IP Address/Hostname** field.
3. Select **Save Changes** to save the new entries. The **Control System Save** message box appears, indicating that the control system settings were saved successfully. Select **Revert** to revert to the previous settings without saving.

Cloud Settings

Set the **Cloud Settings** toggle to enabled (right) or disabled (left) to specify whether the DM-NAX-AUD-USB can communicate with the XiO Cloud® platform.

Device Modes

Use the **Device Modes** tab to configure the **Application Mode** of the DM-NAX-AUD-USB.

Application Mode: Commercial (Advanced)

Application Mode determines which options and controls are available.

- Select **Residential (Standard)** or **Commercial (Advanced)**. A **Reboot** confirmation message box appears.

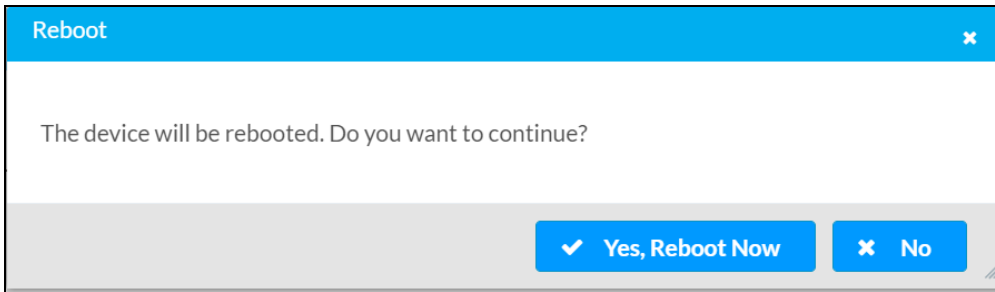

- Select **Yes, Reboot Now** to reboot the device into the selected mode. The **Reboot** message box appears.
- Wait for the device reboot to complete before attempting to reconnect to the device.

By default, the DM-NAX-AUD-USB is set to **Commercial (Advanced)** mode.

Commissioning

The **Commissioning** section provides a quick way to automatically assign multicast addresses to the device's internal audio-over-IP stream transmitters.

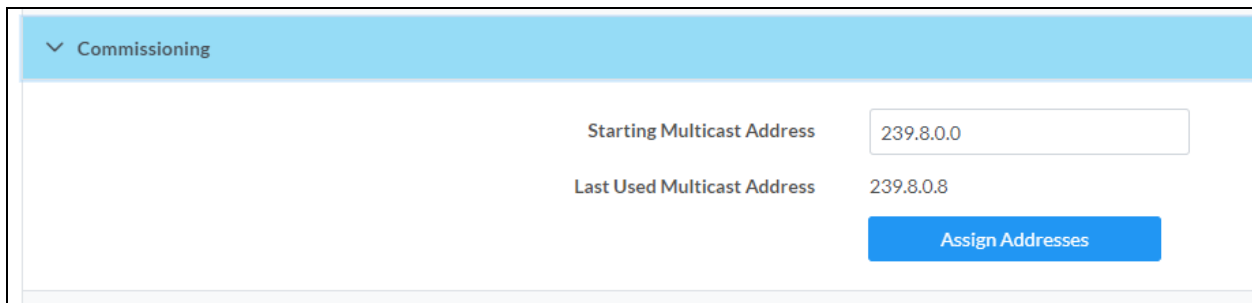

Select **Assign Addresses** to give each DM NAX transmitter in the DM-NAX-AUD-USB a unique multicast address beginning with the specified **Starting Multicast Address**. The valid range for **Starting Multicast Address** is 239.8.0.0 to 239.255.255.254.

NOTE: This will begin transmitting multicast traffic on your network. Refer to [Audio-over-IP Network Design on page 632](#) for details on proper audio-over-IP network management.

Output Channels

The **Zones** section contains the **Volume** and **Mute** settings for all zone outputs of the device, as well as an **Edit** option for more advanced settings within each zone.

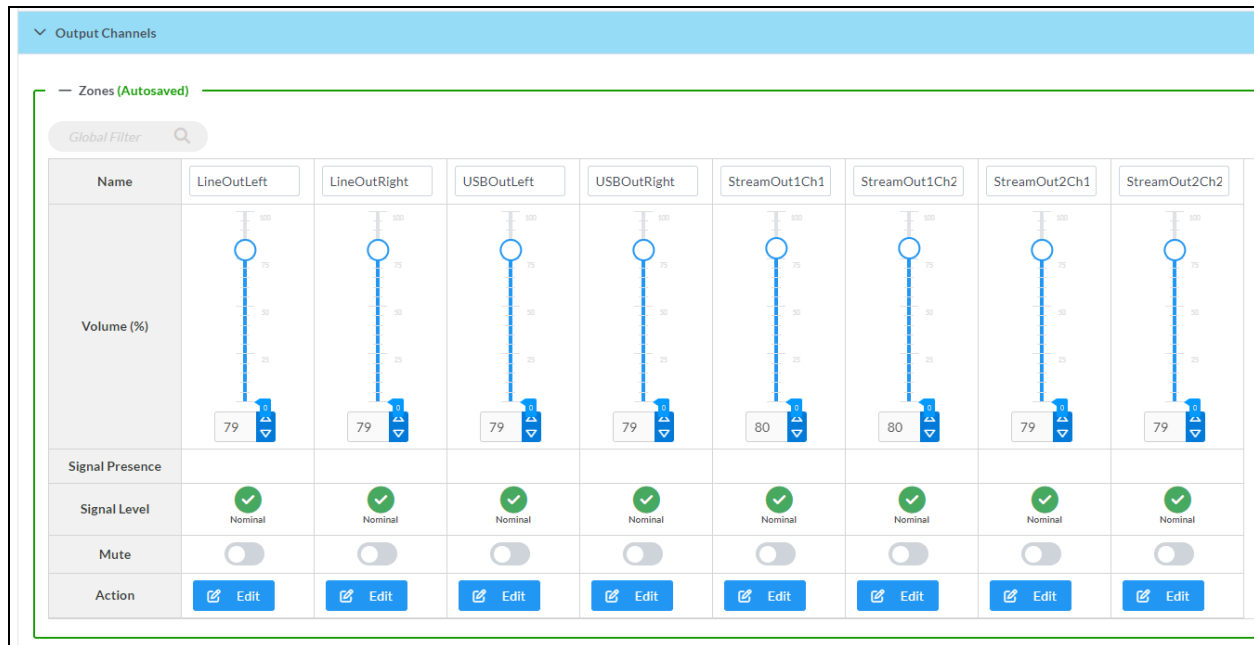

The screenshot shows a web interface for configuring output channels. At the top, there is a 'Global Filter' search bar. Below it, a table lists various output channels with their respective settings. Each channel has a volume slider, a signal presence indicator, a signal level indicator, a mute toggle, and an edit button.

Name	LineOutLeft	LineOutRight	USBOutLeft	USBOutRight	StreamOut1Ch1	StreamOut1Ch2	StreamOut2Ch1	StreamOut2Ch2
Volume (%)	79	79	79	79	80	80	79	79
Signal Presence	<input checked="" type="checkbox"/>	<input checked="" type="checkbox"/>	<input checked="" type="checkbox"/>	<input checked="" type="checkbox"/>	<input checked="" type="checkbox"/>	<input checked="" type="checkbox"/>	<input checked="" type="checkbox"/>	<input checked="" type="checkbox"/>
Signal Level	Nominal	Nominal	Nominal	Nominal	Nominal	Nominal	Nominal	Nominal
Mute	<input type="checkbox"/>	<input type="checkbox"/>	<input type="checkbox"/>	<input type="checkbox"/>	<input type="checkbox"/>	<input type="checkbox"/>	<input type="checkbox"/>	<input type="checkbox"/>
Action	Edit	Edit	Edit	Edit	Edit	Edit	Edit	Edit

Signal Presence indicates whether or not an audio signal is detected in that zone.

Signal Level indicates if the signal is **Clipping** or **Nominal** (non-clipping).

- **Nominal:** The signal level is within normal operating bounds and below the clipping threshold.
- **Clipping:** The signal level is clipping or above the -3 dB warning threshold and in danger of clipping.

Give each zone a friendly name using the **Name** column of the **Zones** table. If the device is paired with a control system, these names may be overwritten by the control system's program.

To configure the zone volume, do one of the following:

- Move the **Volume** slider up to increase or down to decrease the zone volume.
- Use the **%** arrows to increase or decrease the zone volume. Values range from 0 to 100%, adjustable in increments of 1%.
- Manually enter a value in the **Volume** field.

To mute all audio output from a zone, select its respective **Mute**. To unmute the zone, select **Muted**.

Select **Edit** to view additional **Zone** and **Output** options.

Zone Settings

To configure the settings for an output channel, select **Edit**. The **Edit Zone** window appears.

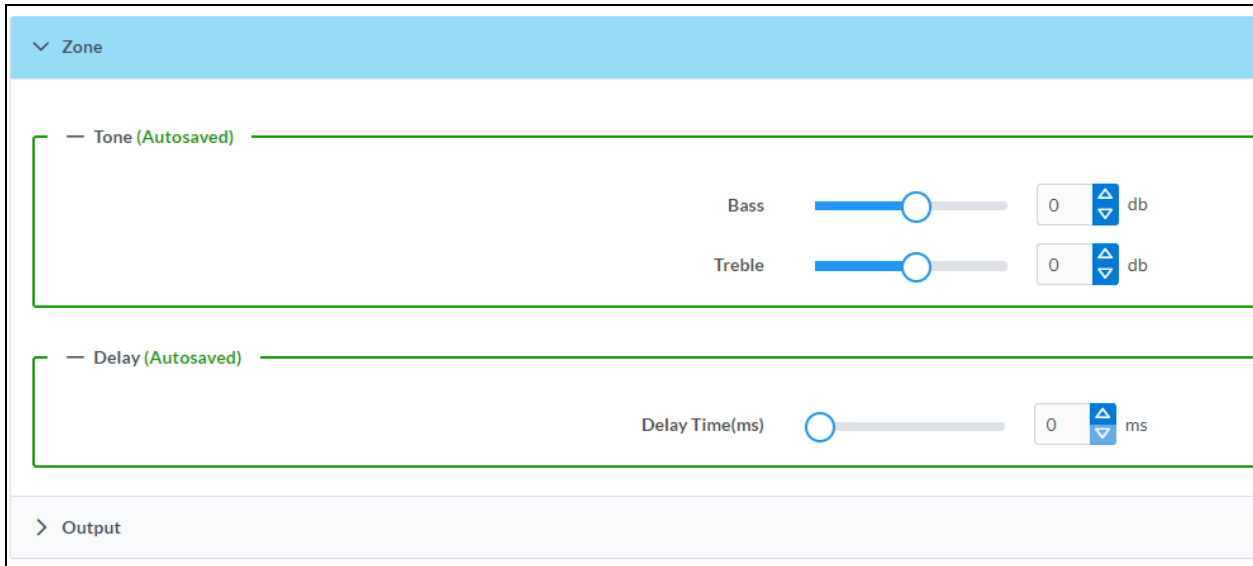

Zone

Select **Zone** to access the settings for **Tone** and **Delay**.

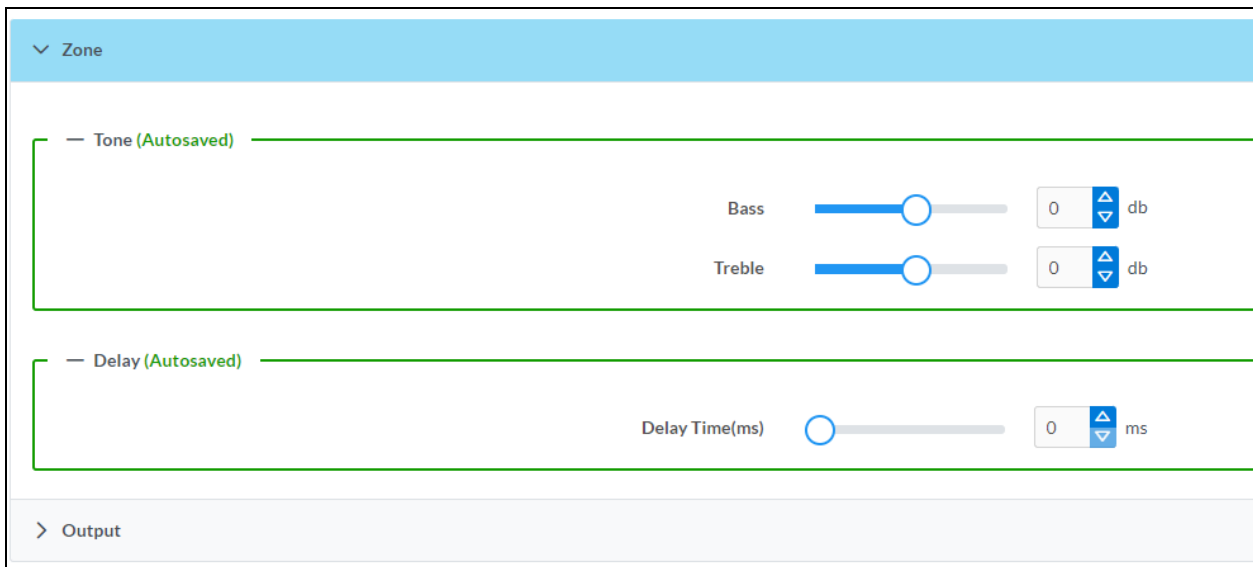

Tone

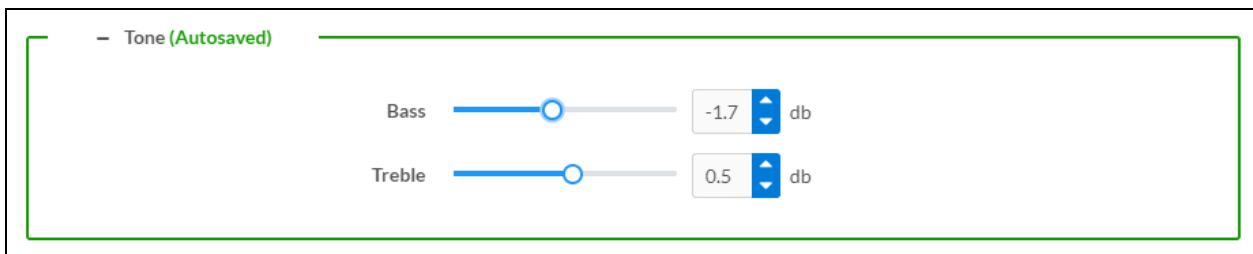

- **Bass:** To adjust the bass, do one of the following:
 - Move the **Bass** slider to the right to increase or to the left to decrease the bass db.
 - Use the **db** arrows to increase or decrease the bass level. Values range from -12 dB to 12 dB, adjustable in increments of .1 dB.
 - Manually enter a value in the **Bass** field.
- **Treble:** To adjust the treble, do one of the following:
 - Move the **Treble** slider to the right to increase or to the left to decrease the treble db.
 - Use the **db** arrows to increase or decrease the treble level. Values range from -12 dB to 12 dB, adjustable in increments of .1 dB.
 - Manually enter a value in the **Treble** field.

Delay

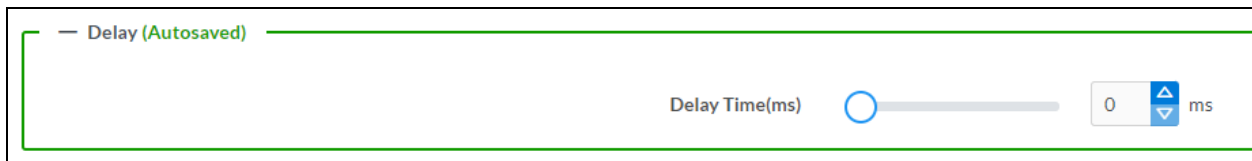

To set the delay, do one of the following:

- Move the **Delay Time(ms)** slider to the right to increase or to the left to decrease the delay time.
- Use the **ms** arrows to increase or decrease the delay. Values range from 0 ms to 85 ms, adjustable in increments of 1 ms.
- Manually enter a value in the **Delay Time(ms)** field.

NOTE: The Delay feature is only available on the line level output channels.

Output

Select **Output** to access the settings for **Minimum/Maximum Volume**, **Signal**, and the output **Equalizer**.

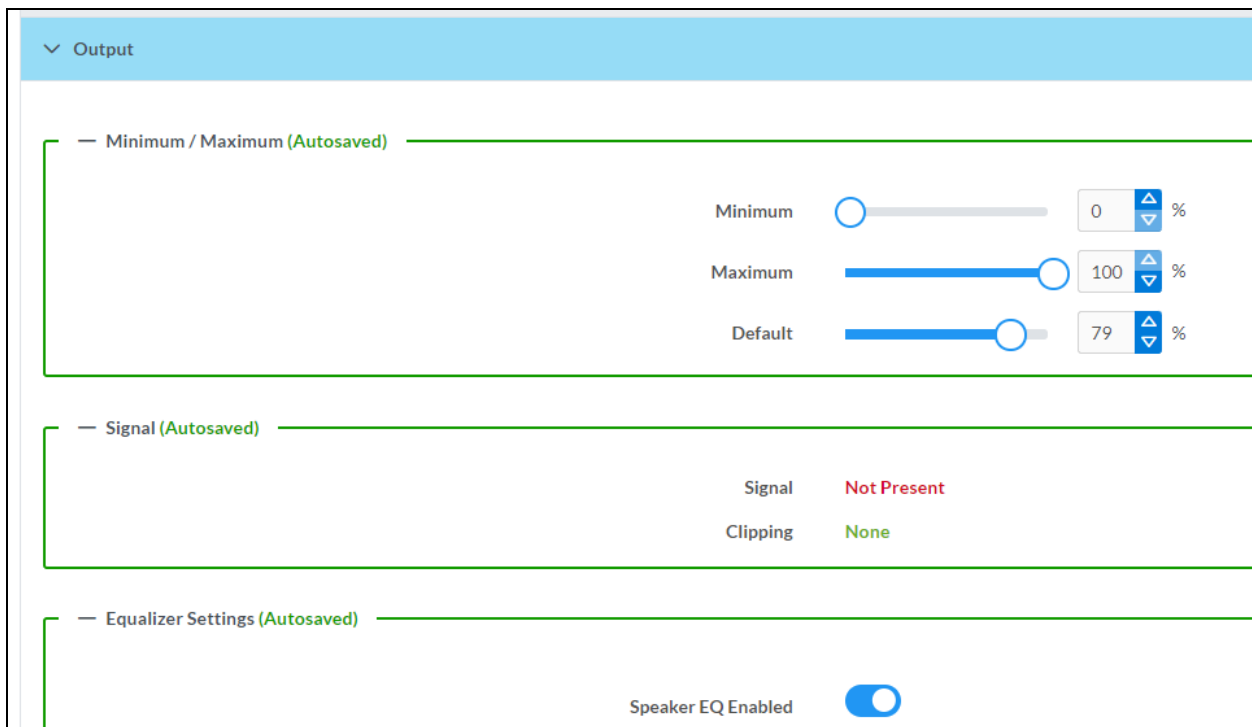

Minimum/Maximum Volume

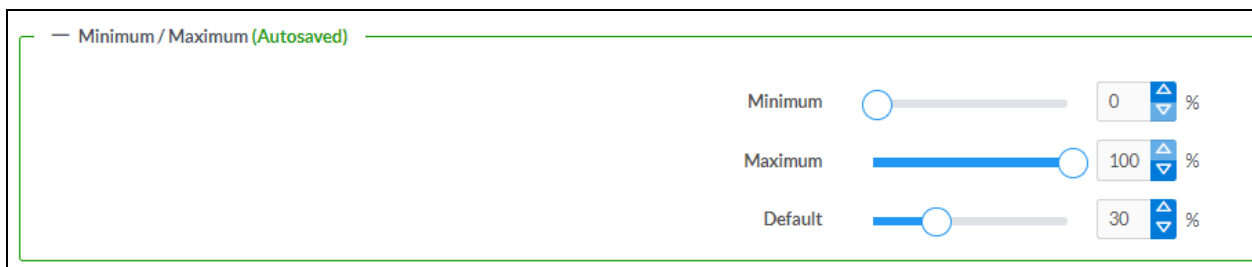

1. To set the minimum volume of the zone, do one of the following:
 - Move the **Minimum** slider to the right to increase or to the left to decrease the minimum volume.
 - Use the **%** arrows to increase or decrease the minimum volume. Values range from 0 to 50%, adjustable in increments of 1%.
 - Manually enter a value in the **Minimum** field.

- To set the maximum volume of the zone, do one of the following:
 - Move the **Maximum** slider to the right to increase or to the left to decrease the maximum volume.
 - Use the **%** arrows to increase or decrease the maximum volume. Values range from 70 to 100%, adjustable in increments of 1%.
 - Manually enter a value in the **Maximum** field.

NOTE: When a **Minimum** and **Maximum** volume are set, the 1-100% range represented by the **Zone** and **Default** volume controls are scaled to the range set. For example, if a **Minimum** of 10% and a **Maximum** of 80% are set for a zone, the 1-100% range of the **Zone** volume control is scaled to the 10%-80% range set as the **Minimum** and **Maximum**.

- To set the default volume of the zone, do one of the following:
 - Move the **Default** slider to the right to increase or to the left to decrease the default volume.
 - Use the **%** arrows to increase or decrease the default volume. Values range from 0 to 50%, adjustable in increments of 1%.
 - Manually enter a value in the **Default** field.

NOTE: The **Default** volume is applied as the **Zone** volume any time the zone receives a source route and no source was previously routed to that zone.

Signal

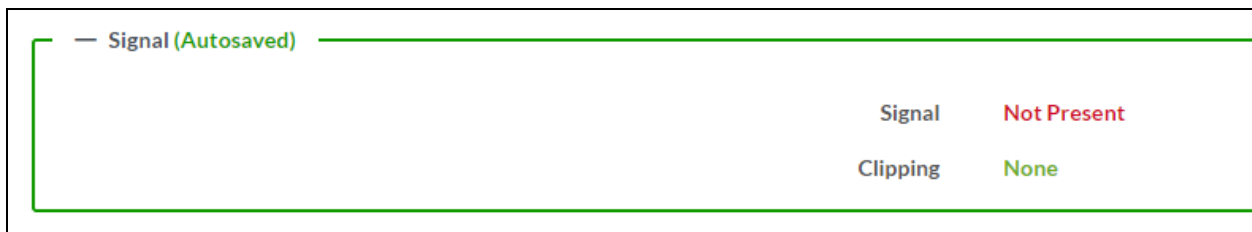

The **Signal** section is a read-only field that displays the **Signal** and **Clipping** status of the zone output.

- If an output signal is present but not clipping, **Signal** will display **Present** in green and **Clipping** will display **None** in green.
- If an output signal is present and clipping, **Signal** will display **Present** in green and **Clipping** will display **Present** in red.
- If no output signal is detected, **Signal** will display **Not Present** in red and **Clipping** will display **None** in green.

Equalizer Settings

Band	Band01	Band02	Band03	Band04	Band05	Band06	Band07	Band08	Band09	Band10
Gain	<input type="range" value="0"/>	<input type="range" value="0"/>	<input type="range" value="0"/>	<input type="range" value="0"/>	<input type="range" value="0"/>	<input type="range" value="0"/>	<input type="range" value="0"/>	<input type="range" value="0"/>	<input type="range" value="0"/>	<input type="range" value="0"/>
Type	EQ	EQ	EQ	EQ	EQ	EQ	EQ	EQ	EQ	EQ
Frequency	32	64	125	250	500	1000	2000	4000	8000	16000
Bandwidth	0.33	0.33	0.33	0.33	0.33	0.33	0.33	0.33	0.33	0.33
Bypass	<input type="checkbox"/>	<input type="checkbox"/>	<input type="checkbox"/>	<input type="checkbox"/>	<input type="checkbox"/>	<input type="checkbox"/>	<input type="checkbox"/>	<input type="checkbox"/>	<input type="checkbox"/>	<input type="checkbox"/>
Actions	Reset	Reset	Reset	Reset	Reset	Reset	Reset	Reset	Reset	Reset

Each output channel of the DM-NAX-AUD-USB has a dedicated ten-band equalizer that can be fully customized to tune the zone output signal to the needs of an install. Each band can have a discrete gain, filter type, center frequency, and bandwidth set, and can also be bypassed. The equalizer itself can also be bypassed using the **Speaker EQ Enabled** toggle.

1. Set the **Speaker EQ Enabled** toggle to the right position to enable the equalizer. Set the toggle to the left position to bypass the equalizer.

NOTE: When **Speaker EQ Enabled** is disabled, all equalizer bands are bypassed. This is a quick way to perform A/B testing of the entire EQ curve.

2. With the **Speaker EQ Enabled** toggle in the right position, configure the equalizer bands.
 - a. To set a band's gain, do one of the following:
 - Move the **Gain** slider up to increase or down to decrease the gain.
 - Use the arrows to increase or decrease the gain. Values range from -40 dB to 20 dB, adjustable in increments of 0.1 dB.
 - Manually enter a value in the **Gain** field.

- b. Select a filter type from the **Type** drop-down menu. By default, all bands are set to the **EQ** filter type. Some filter types will disable other settings in their respective band while enabled. For example, selecting the **LowPass** filter type for a band will disable that band's **Gain** and **Bandwidth** settings, since the **LowPass** filter applies a fixed roll-off slope at a set frequency. The available filter types are:
- **EQ:** a fully parametric filter that can boost or cut a range of frequencies.
 - **Notch:** a parametric filter designed to more precisely cut a frequency or range of frequencies. A notch filter can achieve a narrower bandwidth than the standard **EQ** parametric filter type.
 - **TrebleShelf:** a filter that boosts or cuts all frequencies above a set frequency by a set gain.
 - **BassShelf:** a filter that boosts or cuts all frequencies below a set frequency by a set gain.
 - **LowPass:** a filter that fully cuts all frequencies above a set frequency using a fixed roll-off slope of -12 dB per octave.
 - **HighPass:** a filter that fully cuts all frequencies below a set frequency using a fixed roll-off slope of -12 dB per octave.
- c. Set a center frequency for the equalizer band to tune a specific portion of the audible frequency spectrum. To set the center frequency, do one of the following:
- Use the arrows to increase or decrease the frequency. Values range from 20 Hz to 20 kHz, adjustable in increments of 1 Hz. Each band has a default center frequency that will be applied if **Reset** at the bottom of the band is selected.
 - Manually enter a value in the **Frequency** field.
- d. Set a bandwidth to determine how wide of a frequency range is effected by the equalizer band. To set the bandwidth, do one of the following:
- Use the arrows to increase or decrease the bandwidth. Values range from 0.1 octaves to 4.0 octaves, adjustable in increments of 0.1 octave.
 - Manually enter a value in the **Bandwidth** field.
- e. The individual Bypass controls allow you to bypass a single band of equalization at a time for more granular A/B testing of a single filter. Set a band's **Bypass** toggle to the right position to bypass that band. Set the toggle to the left position to disable the bypass. By default, **Bypass** is disabled.
- f. Each equalizer band has a **Reset** that will reapply the default settings for that band.

Select **Done** to return to the **Settings** tab of the web user interface.

Input Channels

The **Input Channels** section is used to configure the **Name**, **Compensation**, and **Mute** attributes of the front panel inputs on the DM-NAX-AUD-USB.

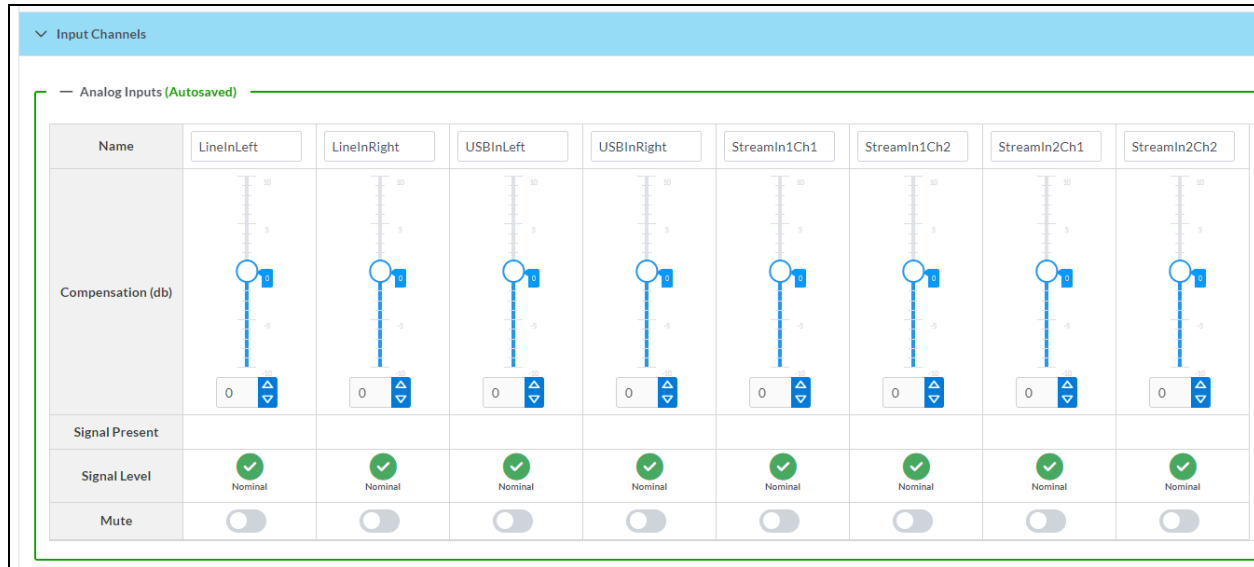

Input Channels								
Analog Inputs (Autosaved)								
Name	LineInLeft	LineInRight	USBInLeft	USBInRight	StreamIn1Ch1	StreamIn1Ch2	StreamIn2Ch1	StreamIn2Ch2
Compensation (db)								
Signal Present								
Signal Level								
Mute	<input type="checkbox"/>	<input type="checkbox"/>	<input type="checkbox"/>	<input type="checkbox"/>	<input type="checkbox"/>	<input type="checkbox"/>	<input type="checkbox"/>	<input type="checkbox"/>

Configure Inputs

1. If needed, enter a friendly name for each input in its **Name** field.
2. To set a level compensation adjustment for a given input, do one of the following:
 - Move the **Compensation** slider up to increase or down to decrease the level compensation. Compensation increases or decreases the level of the incoming audio signal on any of the physical inputs on the device's rear panel.
 - Use the **db** arrows to increase or decrease the compensation. Values range from -10 dB to 10 dB, adjustable in increments of 1 dB.
 - Manually enter a value in the **Compensation** field.
3. To mute the signal from the corresponding input, set the **Mute** toggle to the right. To disable the mute, set the **Mute** toggle to the left. By default, **Mute** is disabled.

Monitor the device's input signals using the text indicators in the **Signal Present** and **Clipping Detected** columns:

- **Signal Presence** indicates whether or not a signal is detected in that zone.
- **Clipping Detected** indicates if the signal is **Clipping** or **Nominal** (non-clipping).

DM NAX Streams

The local inputs of the DM-NAX-AUD-USB can be made available as DM NAX audio-over-IP streams. Two network stream transmitters are available on the device. One transmitter will encode the local unbalanced line level input, and the other will encode the USB input audio.

Select **NAX Streams** to expand the tab and display the following information.

This Device is the Leader PTP Clock Source **No**
 PTP Clock Leader MAC Address 00:1d:c1:12:16:68
 PTP Priority 254

— Transmitters (Autosaved)

Audio Source	Stream	Nax Stream Address	Nax Stream Name	Status	Actions
StreamOut1Ch1	Stream01	239.69.18.1	Stream01-AUD-USB	Stream Started	▶ ⏏ ⚙
StreamOut2Ch1	Stream02	239.69.18.2	Stream02-AUD-USB	Stream Started	▶ ⏏ ⚙

— Receivers (Autosaved)

Zone Name	Stream	Current Stream Address	Requested Stream Address	Status	Actions
StreamIn1Ch1	Stream01	239.69.2.1	239.69.2.1	Stream Started	▶ ⏏ ⚙
StreamIn2Ch1	Stream02	239.69.61.139	239.69.61.139	Stream Started	▶ ⏏ ⚙

- **Device is Leader PTP Clock Source** indicates whether the DM NAX device's PTP clock is the leader clock on the network. **Yes** will be displayed in green when the local DM-NAX-AUD-USB's clock is the PTP leader clock and **No** will be displayed in red when another PTP clock on the network is operating as the leader clock.
- **Leader Clock Status** displays the Leader Clock ID of the device on the network that is currently acting as the leader clock.
- **PTP Priority:** This sets the priority of the local DM NAX device's PTP clock relative to other clocks on the network. The default setting is 254 (one increment higher than the lowest possible value) so that the DM-NAX-AUD-USB will only operate as the leader clock if no other PTP leader is present on the network. Valid values range from 1 to 255.

Configure Transmitters

To configure the DM NAX transmit stream:

1. Enter a valid multicast address in the **NAX Stream Address** field.
2. Enter a name in the **NAX Stream Name** field by which the stream can be identified. This stream name is associated with the DM NAX stream's multicast address by other DM NAX or AES67 devices, like a device hostname that resolves to a given IP address.
3. **Status** indicates whether a stream is transmitting or not. When the stream has started or stopped, the **Status** column will update accordingly.
4. Select the configure icon  in the **Actions** column. The **Configure** dialog appears:

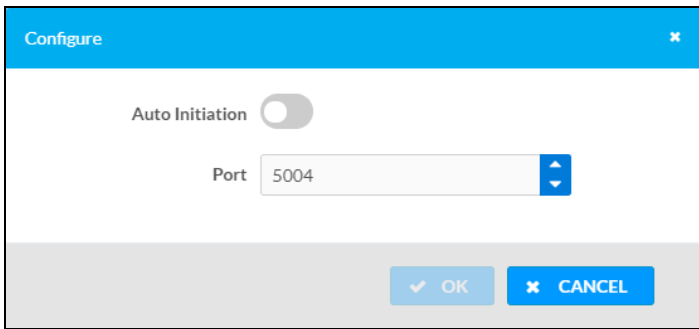

5. Set the **Auto Initiation** toggle to the right position to enable auto initiation. Set the toggle to the left position to disable auto initiation.
 - If **Auto Initiation** is enabled for a given stream, the stream will begin transmitting automatically and will be available as a multicast stream on your network at the specified multicast address.
 - If **Auto Initiation** is disabled for the input, the stream will not begin transmitting until it is manually initiated.
6. To set the port number, do one of the following:
 - Use the arrows to increase or decrease the port number by increments of 1.
 - Manually enter a port number in the **Port** field. The default port number for DM NAX streams is 5004.
7. Select **OK** to save or select **Cancel** to cancel the changes.

Configure Receivers

1. Enter the multicast address of a transmitting stream in the **Requested Stream Address** field to subscribe the receiver to the stream.
2. Select the configure icon  in the **Actions** column. The **Configure** dialog appears:

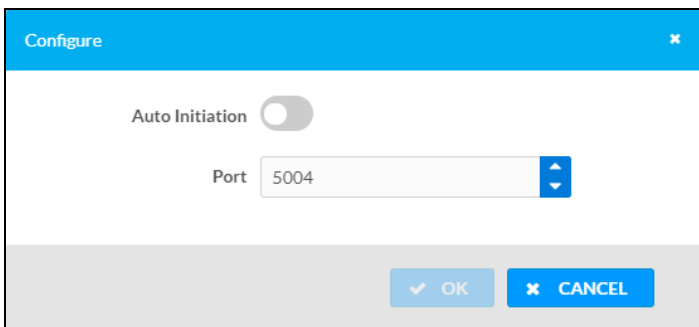

3. Set the **Auto Initiation** toggle to the right position to enable auto initiation. Set the toggle to the left position to disable auto initiation.
 - If **Auto Initiation** is enabled, the stream will begin automatically when the receiver subscribes to the transmitter.
 - If **Auto Initiation** is disabled, the stream will not begin until it is manually initiated.

4. To set the port number, do one of the following:
 - Use the arrows to increase or decrease the port number by increments of 1.
 - Manually enter a port number in the **Port** field. The default port number is 5004.
5. Select **OK** to save or select **Cancel** to cancel the changes.



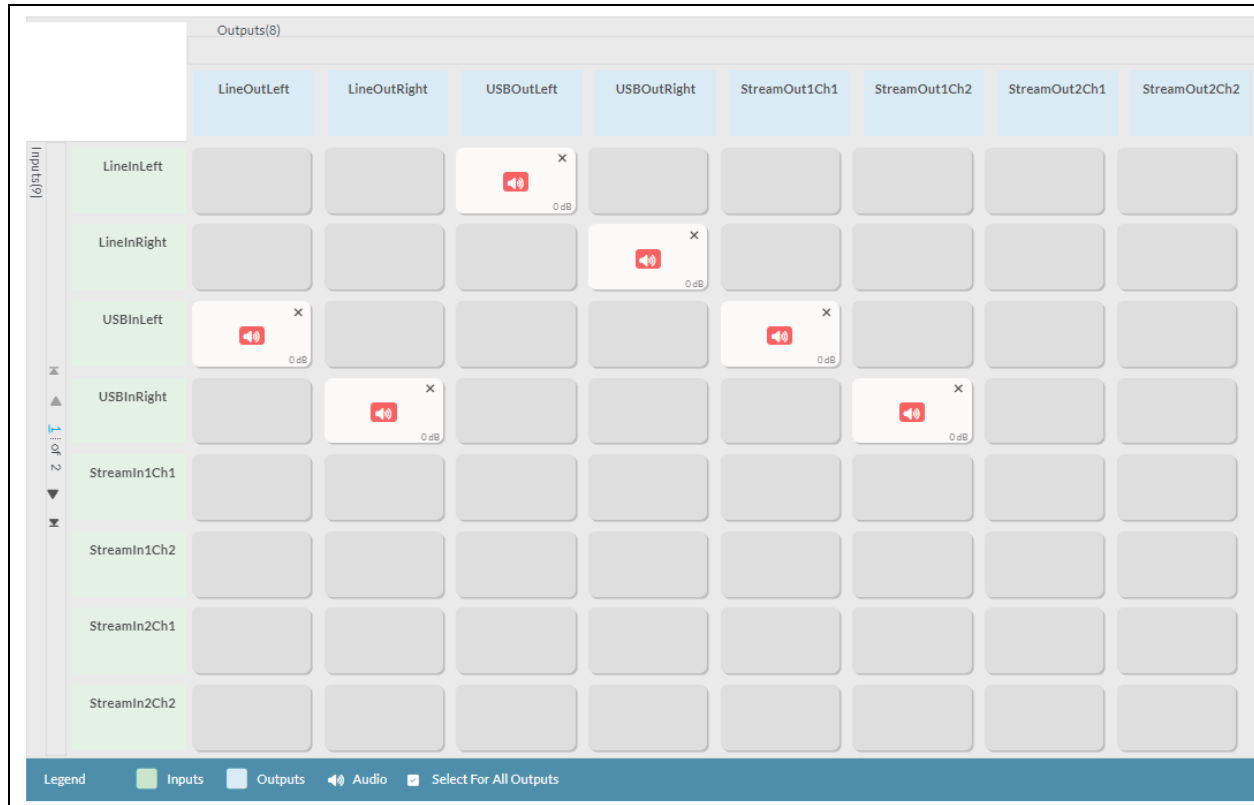

Mixing

The **Mixing** matrix is used to route a local input or AES67 stream to an output on the DM-NAX-AUD-USB.

NOTE: To receive an AES67 stream from Dante devices, see [OLH 1001151](#).



To route inputs to outputs on the device:

- Select the cells corresponding to the desired output that are to be paired for routing. Once a route is made,  appears. The input that you have selected for a given row will route to the output corresponding to that row in the matrix.
- Use the arrows ( or ) at the left of the matrix to change pages to view all available inputs.
- To break a given route select  or .

Each output can have any number of inputs routed to it. To adjust the mix setting for a route, select the **dB** value of the cell, then do one of the following:

- Move the slider up to increase or down to decrease the mix level.
- Use the arrows to increase or decrease the mix level.
- Manually enter a value in the field.

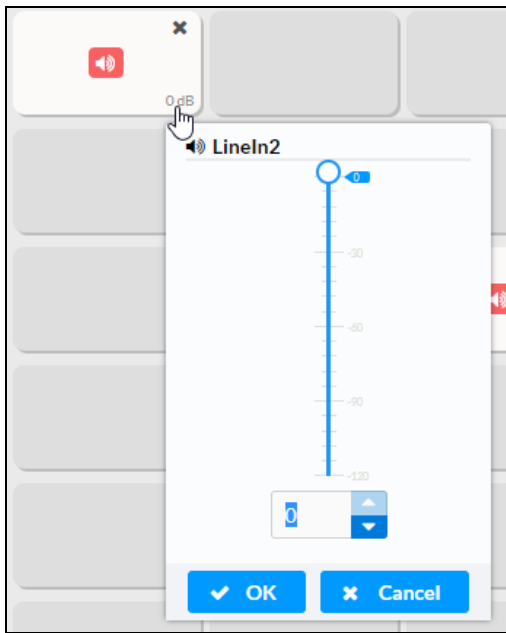

Residential Mode

This section provides the following information:

- [System Setup on page 541](#)
- [Commissioning on page 546](#)
- [Output Channels on page 547](#)
- [Inputs on page 554](#)
- [NAX Streams on page 555](#)
- [Routing on page 558](#)

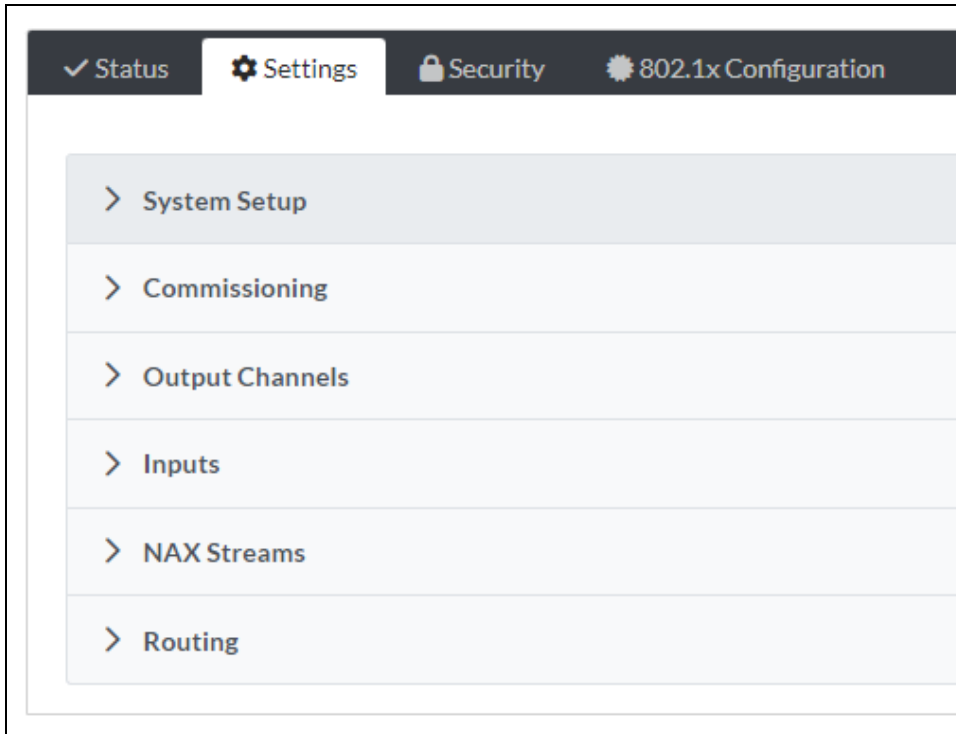

System Setup

The **System Setup** section displays information about the Date/Time, Auto Update, Network, Control System, Cloud Settings, and Device Modes.

Date/Time

Use the **Date/Time** section to configure the date and time settings of the DM-NAX-AUD-USB.

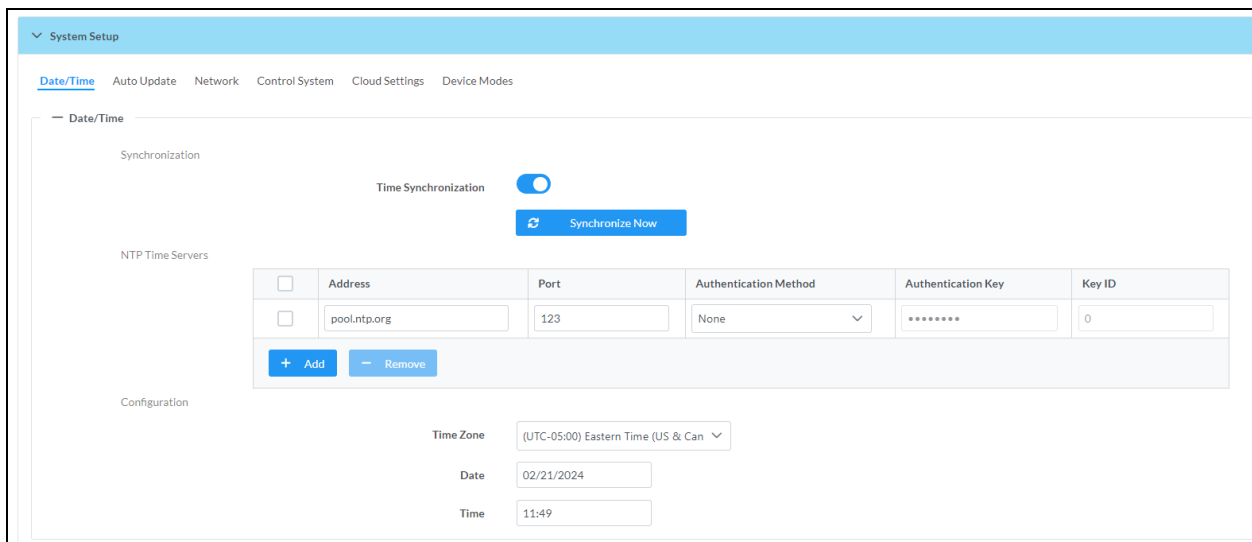

Time Synchronization

1. Set the **Time Synchronization** toggle to the right position to enable or left position to disable time synchronization. By default, time synchronization is enabled.
2. In the **NTP Time Servers** table, enter the URL of a NTP (Network Time Protocol) or SNTP (Simple Network Time Protocol) server. Up to three time servers can be added on a device.
3. Select **Synchronize Now** to perform time synchronization between the device's internal clock and the time server.

Time Configuration

1. Open the **Time Zone** drop-down menu to select the applicable time zone.
2. In the **Date** field, enter the current date.
3. In the **Time (24hr Format)** field, enter the current time in 24-hour format.

Select **Save Changes** to save the settings.

Select **Revert** from the **Actions** drop-down menu to revert to the previous settings without saving.

Auto Update

The DM-NAX-AUD-USB can automatically check for and install firmware updates at scheduled intervals via the **Auto Update** feature.

System Setup

Date/Time **Auto Update** Network Control System Cloud Settings Device Modes

Auto Update

Auto Update

Custom URL

Custom URL Path

Schedule

Day of Week

Time of Day

Poll Interval Minutes

Update Now

1. Set the **Auto Update** toggle to the right position to enable Auto Update.
2. Define the URL to download the updates by doing either of the following:
 - a. Use the default URL to download the updates from the Crestron server.
 - b. Use a custom URL. Set the **Custom URL** toggle to the right position to enable a custom URL. In the **Custom URL Path** text box, enter the path to a custom manifest file in the FTP or SFTP URL format. Use the Crestron Auto Update Tool to generate a custom manifest file, then store the file on an FTP (File Transfer Protocol) or SFTP (Secure File Transfer Protocol) server.
3. Set a schedule for the automatic firmware update by doing either of the following:
 - a. Select the desired **Day of Week** and **Time of Day** (24-hour format) values.
 - b. Set the **Poll Interval** by entering a value from **60** to **65535** minutes. A value of **0** disables the Poll Interval.
4. Select **Save Changes**.

Selecting **Update Now** causes the device to check for a firmware update immediately. If a schedule was set in step 4 above, that schedule still remains in effect.

Network

The **Network** section contains network-related settings for the DM-NAX-AUD-USB, including the Hostname, Domain, Primary Static DNS, and Secondary Static DNS.

System Setup

Date/Time Auto Update **Network** Control System Cloud Settings Device Modes

Network

Adapter 1

Hostname * DM-NAX-AUD-USB-C442683FD459

Domain CRESTRON.CRESTRON.com

Primary Static DNS 10.64.5.10(DHCP)

Secondary Static DNS 192.168.200.133(DHCP)

DHCP Enabled

IP Address 10.64.68.176

Subnet Mask 255.255.255.0

Default Gateway 10.64.68.1

NOTE: By default, the host name of the DM-NAX-AUD-USB consists of the model name followed by the MAC address of the device. For example, DM-NAX-AUD-USB-00107FB58088.

Adapter 1

The Adapter 1 subheading contains settings for DHCP, IP Address, Subnet Mask, and Default Gateway of Ethernet adapter 1 on the rear panel of the device.

NOTE: DM NAX devices' internal processes use IP addresses in the 10.10.10.xxx range. This IP range should be avoided when addressing DM NAX devices to prevent conflicts.

Set the **DHCP** toggle to enabled (right) or disabled (left) to specify whether the IP address of the DM-NAX-AUD-USB is to be assigned by a DHCP (Dynamic Host Configuration Protocol) server.

- **Enabled:** When DHCP is enabled (default setting), the IP address of the DM-NAX-AUD-USB is automatically assigned by a DHCP server on the local area network (LAN).
- **Disabled:** When DHCP is disabled, manually enter information in the following fields:
 - **Primary Static DNS:** Enter a primary DNS IP address.
 - **Secondary Static DNS:** Enter a secondary DNS IP address.
 - **IP Address:** Enter a unique IP address for the DM-NAX-AUD-USB.
 - **Subnet Mask:** Enter the subnet mask that is set on the network.
 - **Default Gateway:** Enter the IP address that is to be used as the network's gateway.

To save any new network entries, select **Save Changes**.

Control System

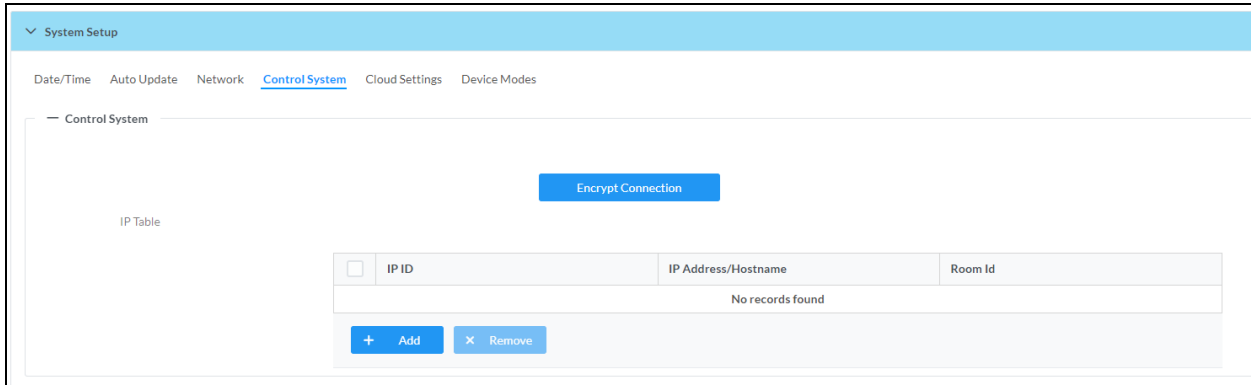

1. Select **Encrypt Connection** to navigate to the **Security** tab to configure encryption settings.
 - a. Enter the username in the **Control System Username** field.
 - b. Enter the password in the **Control System Password** field.
2. Select **+ Add** to add an IP table entry to the **IP Table**.
 - a. Enter the Room ID in the **Room ID** field.
 - b. Enter the IP ID of the DM-NAX-AUD-USB in the **IP ID** field.
 - c. Enter the IP address or hostname of the control system in the **IP Address/Hostname** field.
3. Select **Save Changes** to save the new entries. The **Control System Save** message box appears, indicating that the control system settings were saved successfully. Select **Revert** to revert to the previous settings without saving.

Cloud Settings



Set the **Cloud Settings** toggle to enabled (right) or disabled (left) to specify whether the DM-NAX-AUD-USB can communicate with the XiO Cloud® platform.

Device Modes

Use the **Device Modes** section to configure the **Application Mode**.

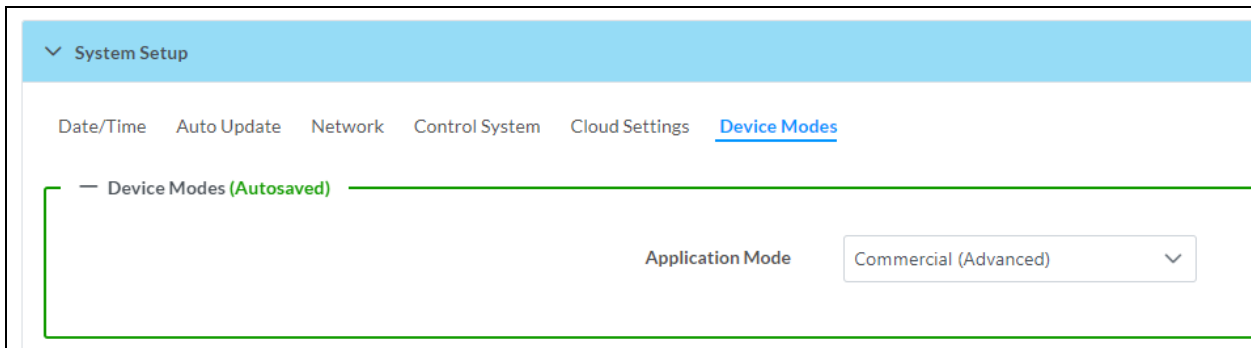

- **Application Mode:** The Application Mode determines which options and controls are available.
 - Select **Residential (Standard)** or **Commercial (Advanced)**. A **Reboot** confirmation message box appears.

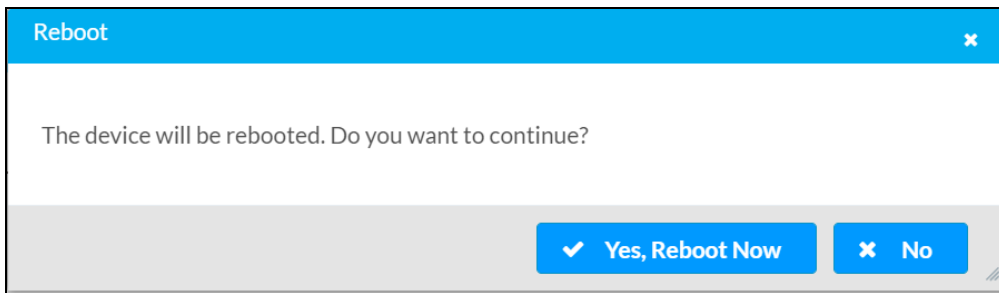

- Select **Yes, Reboot Now** to reboot the device into the selected mode. The **Reboot** message box appears.
- Wait for the device reboot to complete before attempting to reconnect to the device.

Commissioning

The **Commissioning** section provides a quick way to automatically assign multicast addresses to the device's internal audio-over-IP stream transmitters.

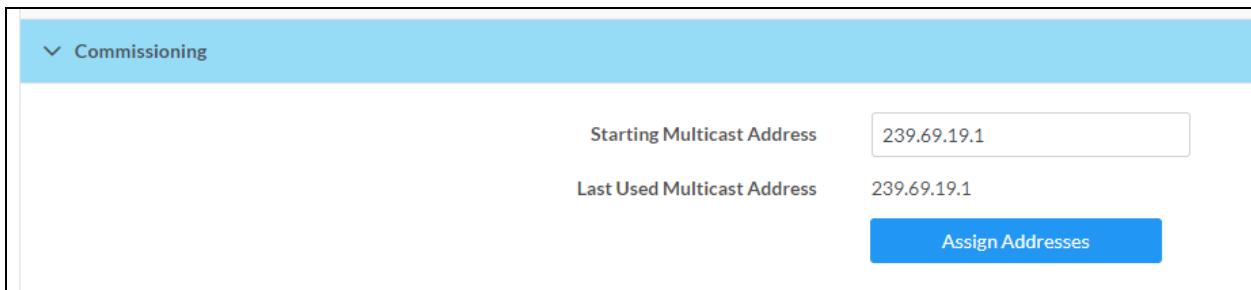

Select **Assign Addresses** to give each DM NAX transmitter in the DM-NAX-AUD-USB a unique multicast address beginning with the specified **Starting Multicast Address**. The valid range for **Starting Multicast Address** is 239.8.0.0 to 239.127.255.254.

NOTE: This will begin transmitting multicast traffic on your network. Refer to [Audio-over-IP Network Design on page 632](#) for details on proper audio-over-IP network management.

Output Channels

The **Zones** section contains the **Volume** and **Mute** settings for all zone outputs of the device, as well as a Configure option for more advanced settings within each zone.

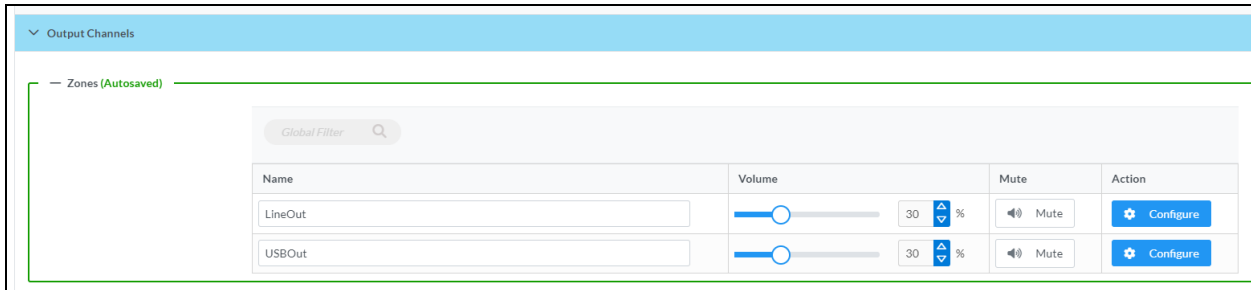

Give each zone a friendly name using the **Name** column of the **Zones** table. If the device is paired with a control system, these names may be overwritten by the control system's program.

To configure the zone volume, do one of the following:

- Move the **Volume** slider to the right to increase or to the left to decrease the zone volume.
- Use the **%** arrows to increase or decrease the zone volume. Values range from 0 to 100%, adjustable in increments of 1%.
- Manually enter a value in the **Volume** field.

To mute all audio output from a zone, select its respective **Mute**. To unmute the zone, select **Muted**.

Zone Settings

To configure zone settings, select **Configure** ([Configure](#)). The **Edit Zone** window appears.

Zone

Select **Zone** to access the settings for **Tone**, **Balance**, and **Delay**.

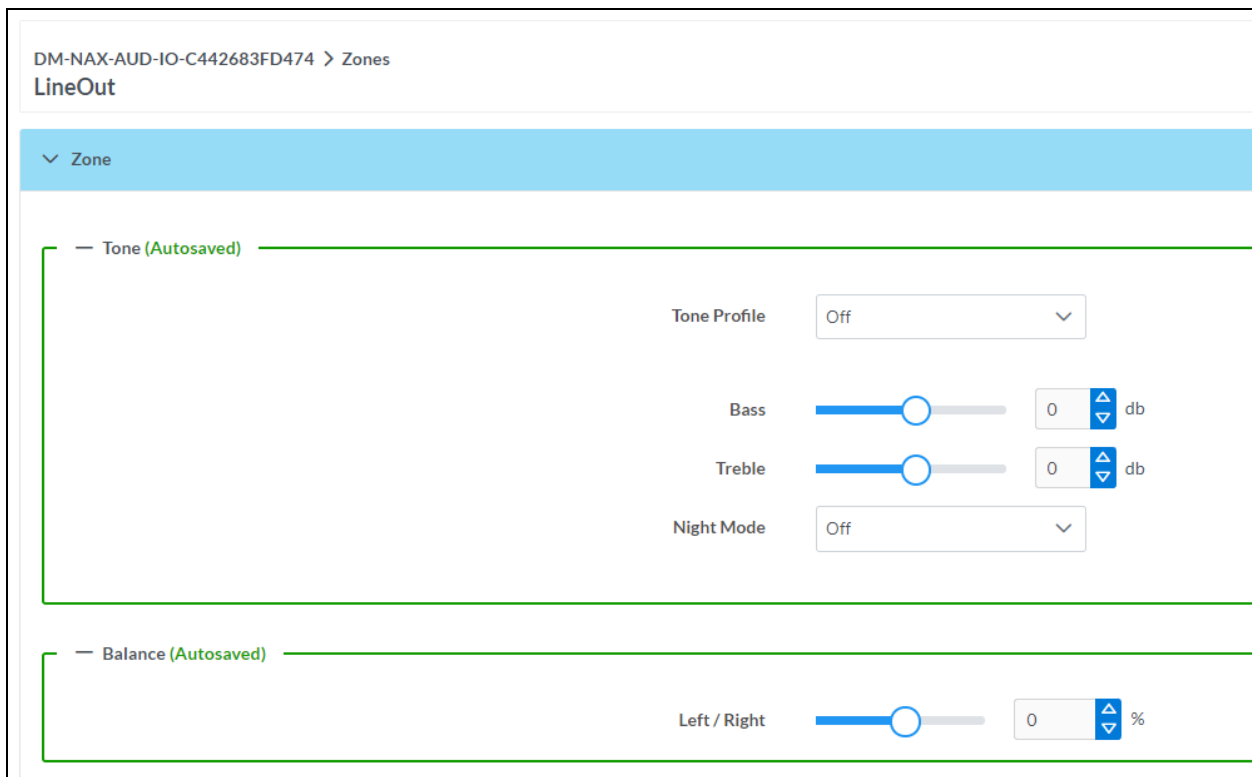

The **Tone** section provides adjustments for the **Tone Profile**, **Bass**, **Treble**, **Loudness**, and **Night Mode** settings of the zone output.

NOTE: The Tone Profile, Bass, Treble, and Loudness settings in the Tone section are all applied separately from the Equalizer Settings for the zone. This means that any adjustments made in the Tone section will stack with those made in the Equalizer Settings section.

1. To select a tone profile preset for the zone, select an option from the **Tone Profile** drop-down menu. The available options are **Off**, **Classical**, **Jazz**, **Pop**, **Rock**, and **Spoken Word**. By default, **Off** is selected.
2. **Bass:** To adjust the bass, do one of the following:
 - Move the **Bass** slider to the right to increase or to the left to decrease the bass.
 - Use the **db** arrows to increase or decrease the bass level. Values range from -12 dB to 12 dB, adjustable in increments of 1 dB.
 - Manually enter a value in the **Bass** field.
3. **Treble:** To adjust the treble, do one of the following:
 - Move the **Treble** slider to the right to increase or to the left to decrease the treble.
 - Use the **db** arrows to increase or decrease the treble level. Values range from -12 dB to 12 dB, adjustable in increments of 1 dB.
 - Manually enter a value in the **Treble** field.
4. To enable the loudness setting on the zone output, slide the **Loudness** switch to the right. To disable loudness, slide the **Loudness** switch to the left.

5. The **Night Mode** feature applies subtle processing to restrict the dynamic range of the zone audio, to allow for lower listening levels at night or in rooms where higher listening levels would be disruptive. To select a dynamics processing level, select an option from the **Night Mode** drop-down menu. The available options are **Off**, **Low**, **Medium**, and **High**. By default, **Off** is selected.

Balance

To adjust the left/right balance of the stereo output signal, do one of the following:

- Move the **Balance** slider to the right to shift the stereo balance to the right channel or to the left to shift the balance to the left.
- Use the arrows to adjust the balance left or right. The up arrow shifts the balance to the right while the down arrow shifts the balance to the left.
- Manually enter a value in the **Balance** field. Values range from -50 to 50, adjustable in increments of 1. Positive values shift the balance to the right while negative values shift the balance to the left.

Delay

To set the delay, do one of the following:

- Move the **Delay Time(ms)** slider to the right to increase or to the left to decrease the delay time.
- Use the **ms** arrows to increase or decrease the delay. Values range from 0 ms to 85 ms, adjustable in increments of 1 ms.
- Manually enter a value in the **Delay Time(ms)** field.

NOTE: The Delay feature is only available on the line level output channels.

Output

Select **Output** to access the settings for **Minimum/Maximum Volume**, **Stereo/Mono**, **Signal**, **Bussing**, **Volume Offset**, **Signal Generator**, and **Equalizer Settings**.

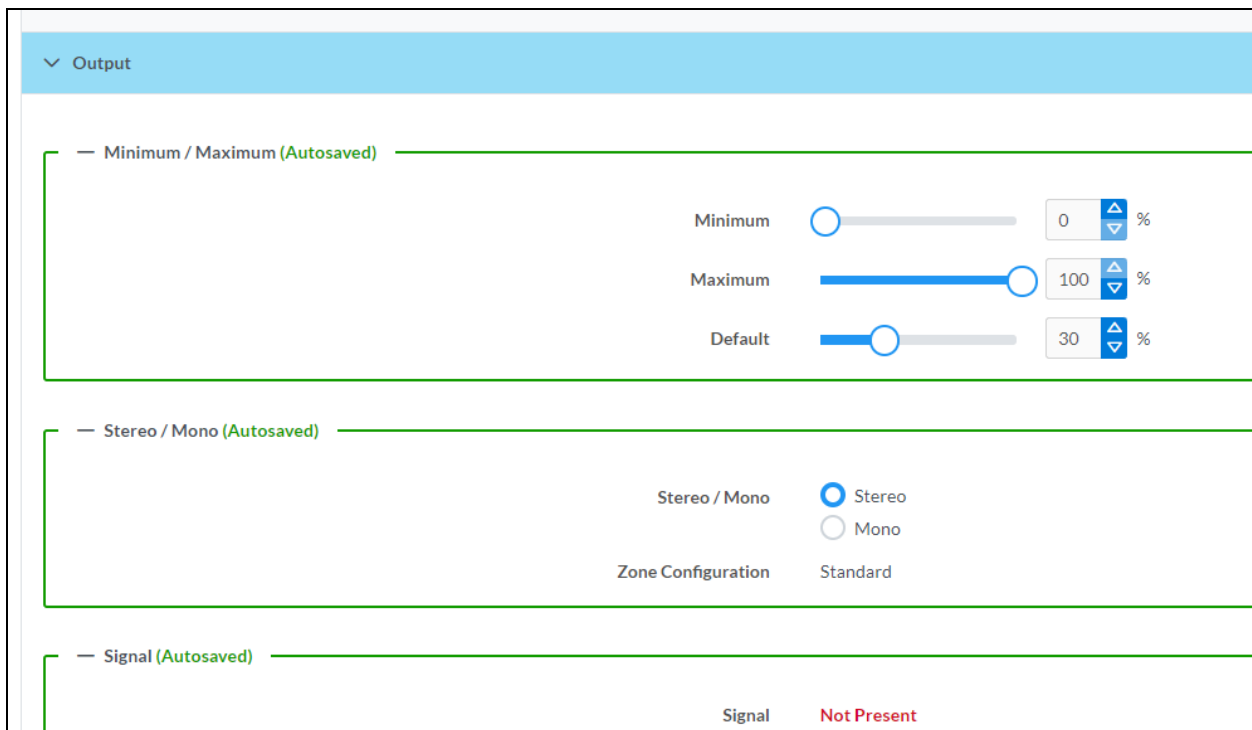

Minimum/Maximum Volume

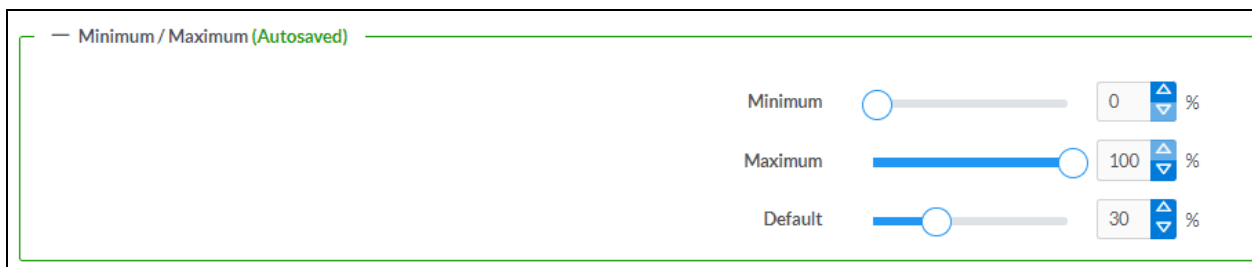

1. To set the minimum volume of the zone, do one of the following:
 - Move the **Minimum** slider to the right to increase or to the left to decrease the minimum volume.
 - Use the **%** arrows to increase or decrease the minimum volume. Values range from 0 to 50%, adjustable in increments of 1%.
 - Manually enter a value in the **Minimum** field.

- To set the maximum volume of the zone, do one of the following:
 - Move the **Maximum** slider to the right to increase or to the left to decrease the maximum volume.
 - Use the **%** arrows to increase or decrease the maximum volume. Values range from 70 to 100%, adjustable in increments of 1%.
 - Manually enter a value in the **Maximum** field.

NOTE: When a **Minimum** and **Maximum** volume are set, the 1-100% range represented by the **Zone** and **Default** volume controls are scaled to the range set. For example, if a **Minimum** of 10% and a **Maximum** of 80% are set for a zone, the 1-100% range of the **Zone** volume control is scaled to the 10%-80% range set as the **Minimum** and **Maximum**.

- To set the default volume of the zone, do one of the following:
 - Move the **Default** slider to the right to increase or to the left to decrease the default volume.
 - Use the **%** arrows to increase or decrease the default volume. Values range from 0 to 50%, adjustable in increments of 1%.
 - Manually enter a value in the **Default** field.

NOTE: The **Default** volume is applied as the **Zone** volume any time the zone receives a source route and no source was previously routed to that zone.

Stereo/Mono

— Stereo / Mono (Autosaved)

Stereo / Mono Stereo
 Mono

Zone Configuration Standard

Select either **Stereo** or **Mono**. If **Stereo** is selected, both output channels can have independent audio content. If **Mono** is selected, both output channels receive the same audio content.

Signal

— Signal (Autosaved)

Signal **Not Present**

Clipping **None**

The **Signal** section is a read-only field that displays the **Signal** and **Clipping** status of the zone output.

- If an output signal is present but not clipping, **Signal** will display **Present** in green and **Clipping** will display **None** in green.
- If an output signal is present and clipping, **Signal** will display **Present** in green and **Clipping** will display **Present** in red.
- If no output signal is detected, **Signal** will display **Not Present** in red and **Clipping** will display **None** in green.

Bussing Volume Offset

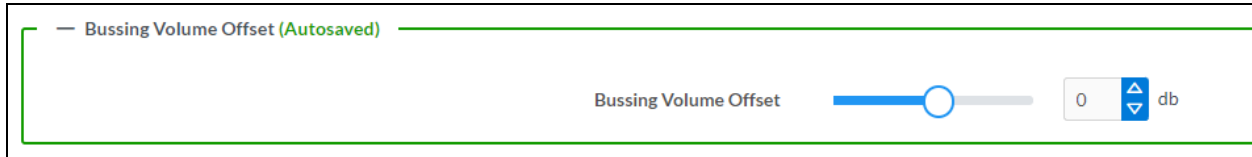

Bussing Volume Offset is an additional level compensation applied to the zone relative to any other zones it is grouped with via the **Bussing** feature.

To set the bussing volume offset, do one of the following:

- Move the **Bussing Volume Offset** slider to the right to increase or to the left to decrease the offset.
- Use the **db** arrows to increase or decrease the offset. Values range from -12 dB to 12 dB, adjustable in increments of 1 dB.
- Manually enter a value in the **Bussing Volume Offset** field.

Signal Generator

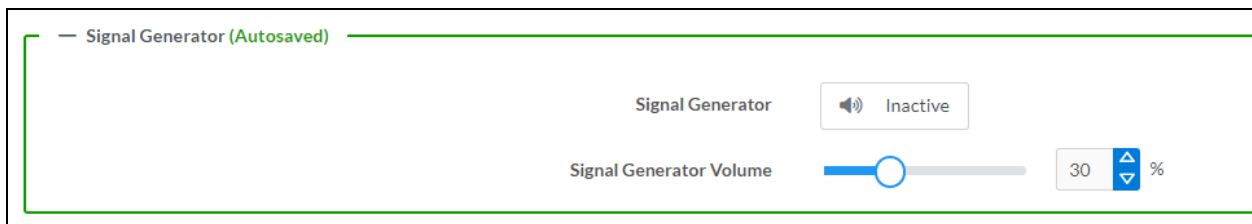

The DM-NAX-AUD-USB has a built-in signal generator that allows an integrator to send an audio signal to the output for testing purposes.

1. To route the signal generator to the zone output, select **Signal Generator** so that it displays **Active** and is highlighted in blue. To unroute the signal generator on the zone output, select **Signal Generator** so that it displays **Inactive** and is highlighted in grey. By default, the signal generator is not routed to the zone output.
2. To adjust the signal generator's volume, do one of the following:
 - Move the **Signal Generator Volume** slider right to increase or left to decrease the volume.
 - Use the arrows to increase or decrease the signal generator volume. Values range from 0 to 100, adjustable in increments of 1.
 - Manually enter a value in the **Signal Generator Volume** field.

Equalizer Settings

Band	Band01	Band02	Band03	Band04	Band05	Band06	Band07	Band08	Band09	Band10
Gain										
Type	EQ	EQ	EQ	EQ	EQ	EQ	EQ	EQ	EQ	EQ
Frequency	32	64	125	250	500	1000	2000	4000	8000	16000
Bandwidth	0.33	0.33	0.33	0.33	0.33	0.33	0.33	0.33	0.33	0.33
Bypass	<input type="checkbox"/>	<input type="checkbox"/>	<input type="checkbox"/>	<input type="checkbox"/>	<input type="checkbox"/>	<input type="checkbox"/>	<input type="checkbox"/>	<input type="checkbox"/>	<input type="checkbox"/>	<input type="checkbox"/>
Actions	Reset	Reset	Reset	Reset	Reset	Reset	Reset	Reset	Reset	Reset

The zone output of the DM-NAX-AUD-USB has a dedicated ten-band equalizer that can be fully customized to tune the zone output signal to the needs of an install. Each band can have a discrete gain, filter type, center frequency, and bandwidth set, and can also be bypassed. The equalizer itself can also be bypassed using the **Speaker EQ Enabled** toggle.

1. Set the **Speaker EQ Enabled** toggle to the right position to enable the equalizer. Set the toggle to the left position to bypass the equalizer.

NOTE: When **Speaker EQ Enabled** is disabled, all equalizer bands are bypassed. This is a quick way to perform A/B testing of the entire EQ curve.

2. With the **Speaker EQ Enabled** toggle in the right position, configure the equalizer bands.
 - a. To set a band's gain, do one of the following:
 - Move the **Gain** slider up to increase or down to decrease the gain.
 - Use the arrows to increase or decrease the gain. Values range from -40 dB to 20 dB, adjustable in increments of 0.1 dB.
 - Manually enter a value in the **Gain** field.

- b. Select a filter type from the **Type** drop-down menu. By default, all bands are set to the **EQ** filter type. Some filter types will disable other settings in their respective band while enabled. For example, selecting the **LowPass** filter type for a band will disable that band's **Gain** and **Bandwidth** settings, since the **LowPass** filter applies a fixed roll-off slope at a set frequency. The available filter types are:
- **EQ:** a fully parametric filter that can boost or cut a range of frequencies.
 - **Notch:** a parametric filter designed to more precisely cut a frequency or range of frequencies. A notch filter can achieve a narrower bandwidth than the standard **EQ** parametric filter type.
 - **TrebleShelf:** a filter that boosts or cuts all frequencies above a set frequency by a set gain.
 - **BassShelf:** a filter that boosts or cuts all frequencies below a set frequency by a set gain.
 - **LowPass:** a filter that fully cuts all frequencies above a set frequency using a fixed roll-off slope of -12 dB per octave.
 - **HighPass:** a filter that fully cuts all frequencies below a set frequency using a fixed roll-off slope of -12 dB per octave.
- c. Set a center frequency for the equalizer band to tune a specific portion of the audible frequency spectrum. To set the center frequency, do one of the following:
- Use the arrows to increase or decrease the frequency. Values range from 20 Hz to 20 kHz, adjustable in increments of 1 Hz. Each band has a default center frequency that will be applied if **Reset** at the bottom of the band is selected.
 - Manually enter a value in the **Frequency** field.
- d. Set a bandwidth to determine how wide of a frequency range is effected by the equalizer band. To set the bandwidth, do one of the following:
- Use the arrows to increase or decrease the bandwidth. Values range from 0.1 octaves to 4.0 octaves, adjustable in increments of 0.1 octave.
 - Manually enter a value in the **Bandwidth** field.
- e. The individual Bypass controls allow you to bypass a single band of equalization at a time for more granular A/B testing of a single filter. Set a band's **Bypass** toggle to the right position to bypass that band. Set the toggle to the left position to disable the bypass. By default, **Bypass** is disabled.
- f. Each equalizer band has a **Reset** that will reapply the default settings for that band.

Select **Done** to return to the **Settings** tab of the web user interface.

Inputs

The **Inputs** section is used to configure the **Name**, **Compensation**, and **Mute** attributes of the available analog, digital, and media streaming inputs on the DM-NAX-AUD-USB.

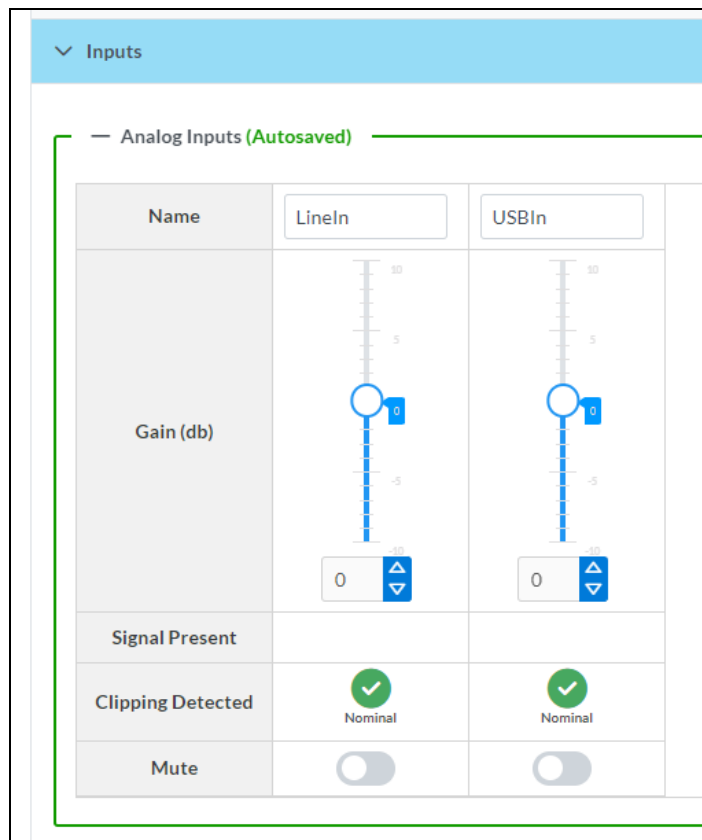

Configure Inputs

1. If needed, enter a friendly name for each input in its **Name** field.
2. To set a level compensation adjustment for a given input, do one of the following:
 - Move the **Compensation** slider up to increase or down to decrease the level compensation. Compensation increases or decreases the level of the incoming audio signal on any of the physical inputs on the device's rear panel.
 - Use the **db** arrows to increase or decrease the compensation. Values range from -10 dB to 10 dB, adjustable in increments of 1 dB.
 - Manually enter a value in the **Compensation** field.
3. To mute the signal from the corresponding input, set the **Mute** toggle to the right. To disable the mute, set the **Mute** toggle to the left. By default, **Mute** is disabled.

Monitor the device's input signals using the text indicators in the **Signal Present** and **Clipping Detected** columns:

- **Signal Presence** indicates whether or not a signal is detected in that zone.
- **Clipping Detected** indicates if the signal is **Clipping** or **Nominal** (non-clipping).

NAX Streams

The two local inputs of the DM-NAX-AUD-USB can be made available as DM NAX audio-over-IP streams.

Select **NAX Streams** to expand the tab and display the following information.

This Device is the Leader PTP Clock Source **No**
 PTP Clock Leader MAC Address 00.1d.c1.12.16.68
 PTP Priority 254

— Transmitters (Autosaved)

Audio Source	Stream	Nax Stream Address	Nax Stream Name	Status	Actions
LineIn	Stream01	239.69.18.1	Stream01-AUD-USB	Stream Started	▶ ⚙
USBIn	Stream02	239.69.18.2	Stream02-AUD-USB	Stream Started	▶ ⚙

— Receivers (Autosaved)

Zone Name	Stream	Current Stream Address	Requested Stream Address	Status	Actions
LineOut	Stream01	239.69.2.1	239.69.2.1	Stream Started	▶ ⚙
USBOut	Stream02	239.69.61.139	239.69.61.139	Stream Started	▶ ⚙

- **Device is Leader PTP Clock Source** indicates whether the device is the leader for PTP on the network. **Yes** will be displayed in green when the local DM-NAX-AUD-USB is the PTP leader clock and **No** will be displayed in red when another PTP clock on the network is operating as the leader clock.
- **Leader Clock Status** displays the Leader Clock ID of the device on the network that acts as the Leader Clock.
- **PTP Priority:** This sets the priority of the local DM NAX device's PTP clock relative to other clocks on the network. The default setting is 254 (one increment higher than the lowest possible value) so that the DM-NAX-AUD-USB will only operate as the leader clock if no other PTP leader is present on the network. Valid values range from 1 to 255.

Configure Transmitters

To configure a DM NAX transmit stream:

1. Enter a valid multicast address in the **NAX Stream Address** field.
2. Enter a name in the **NAX Stream Name** field by which the stream can be identified. This stream name is associated with the DM NAX stream's multicast address by other DM NAX or AES67 devices, like a device hostname that resolves to a given IP address.
3. **Status** indicates whether a stream is transmitting or not. When the stream has started or stopped, the **Status** column will update accordingly.
4. Select the configure icon  in the **Actions** column. The **Configure** dialog appears:

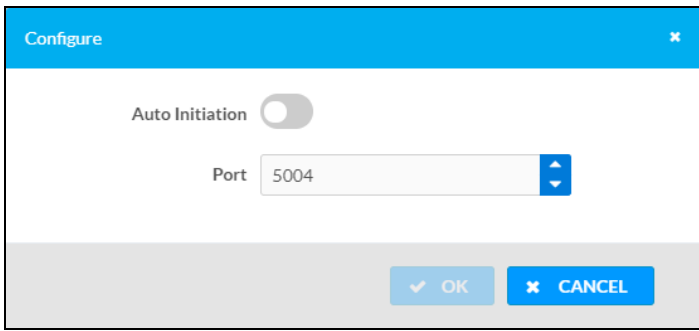

5. Set the **Auto Initiation** toggle to the right position to enable auto initiation. Set the toggle to the left position to disable auto initiation.
 - If **Auto Initiation** is enabled for a given stream, the stream will begin transmitting automatically and will be available as a multicast stream on your network at the specified multicast address.
 - If **Auto Initiation** is disabled for the input, the stream will not begin transmitting until it is manually initiated.
6. To set the port number, do one of the following:
 - Use the arrows to increase or decrease the port number by increments of 1.
 - Manually enter a port number in the **Port** field. The default port number for DM NAX streams is 5004.
7. Select **OK** to save or select **Cancel** to cancel the changes.

Configure Receivers

1. Enter the multicast address of a transmitting stream in the **Requested Stream Address** field to subscribe the receiver to the stream.
2. Select the configure icon  in the **Actions** column. The **Configure** dialog appears:

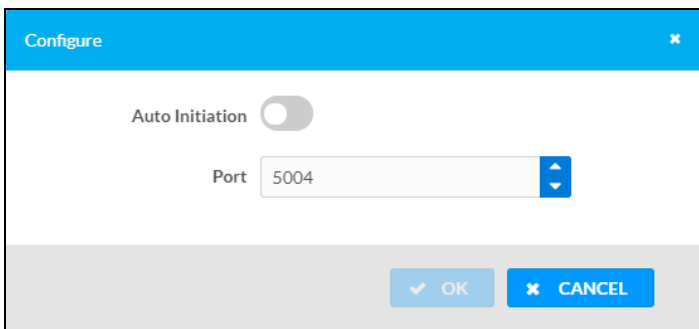

3. Set the **Auto Initiation** toggle to the right position to enable auto initiation. Set the toggle to the left position to disable auto initiation.
 - If **Auto Initiation** is enabled, the stream will begin automatically when the receiver subscribes to the transmitter.
 - If **Auto Initiation** is disabled, the stream will not begin until it is manually initiated.

4. To set the port number, do one of the following:
 - Use the arrows to increase or decrease the port number by increments of 1.
 - Manually enter a port number in the **Port** field. The default port number is 5004.
5. Select **OK** to save or select **Cancel** to cancel the changes.

Routing

The **Routing** section is used to route a local input or AES67 stream to a Zone on the DM-NAX-AUD-USB.

NOTE: To receive an AES67 stream from Dante devices, see [OLH 1001151](#).



- To route an input to a zone, select the box in the routing matrix where the zone's row overlaps the corresponding input's column. Once a route is made, appears.
- To break a given route select or .
- To route a single input to all zones, select the icon under the input's name.

Security

Select the **Security** tab to configure security for users and groups and to allow different levels of access to the DM-NAX-AUD-USB functions. By default, security is disabled.

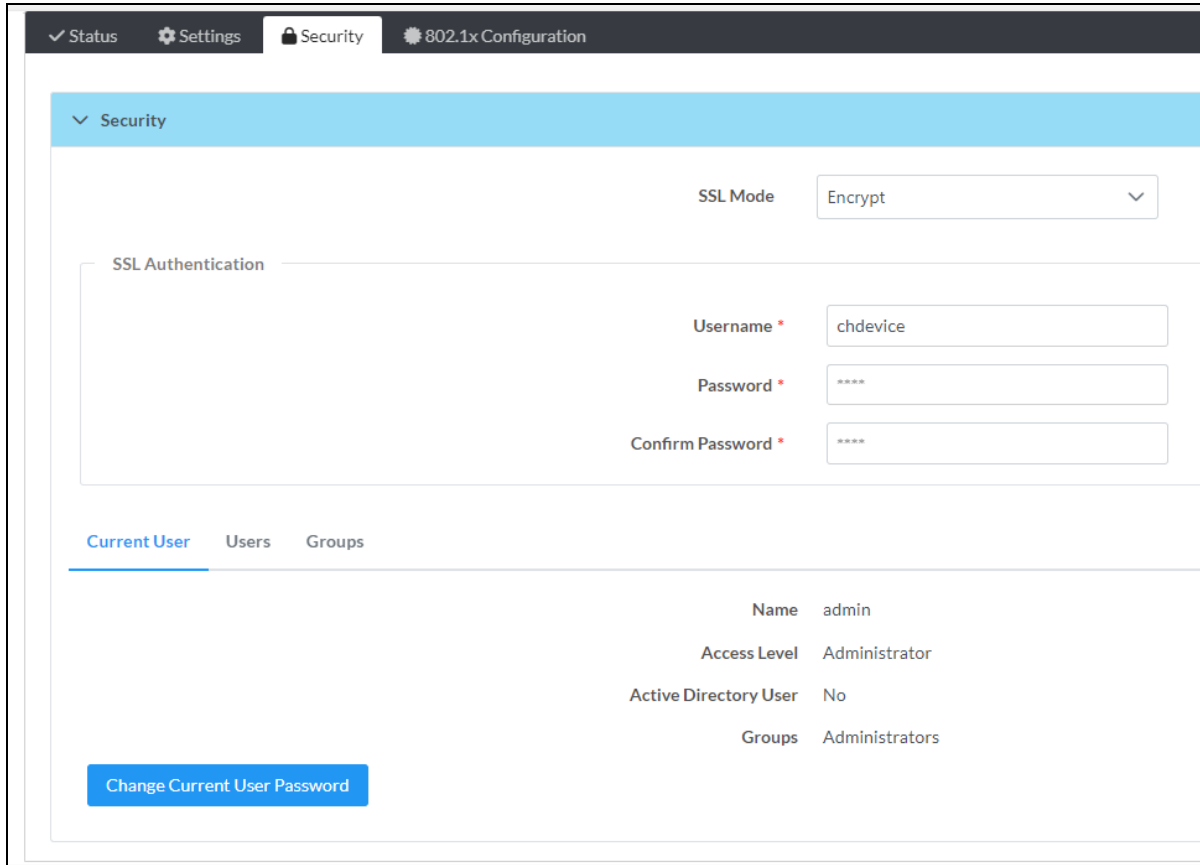

Select **Encrypt and Validate**, **Encrypt**, or **OFF** in the **SSL Mode** drop-down menu, to specify whether to use encryption. By default, SSL Mode is set to **OFF**.

Current User

Select the **Current User** tab to view read-only information or to change the password for the current user.

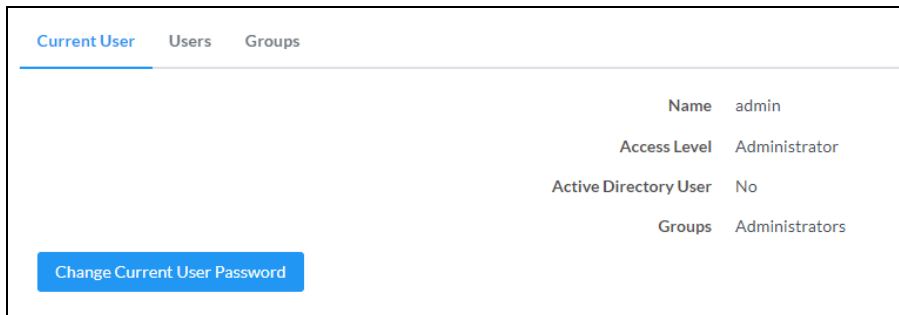

1. Select **Change Current User Password** to provide a new password for the current user.
2. In the **Change Password** dialog, enter the current password in the **Current Password** field, the new password in the **Password** field, and then re-enter the same new password in the **Confirm Password** field.

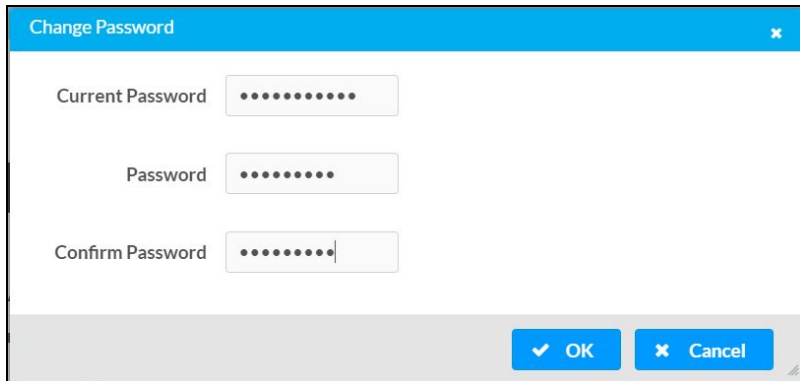

The image shows a 'Change Password' dialog box with a blue header and a close button. It contains three password input fields: 'Current Password', 'Password', and 'Confirm Password'. Each field is filled with dots. At the bottom, there are two buttons: 'OK' with a checkmark icon and 'Cancel' with an 'X' icon.

3. Select **OK** to save or select **Cancel** to cancel the changes.

Users

Select the **Users** tab to view and edit user settings. The **Users** tab can be used to add or remove local and Active Directory users and preview information about users.

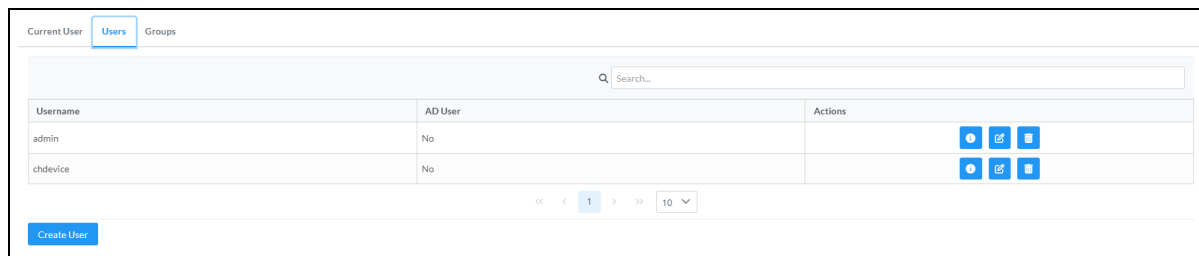

The image shows a web interface for managing users. At the top, there are tabs for 'Current User', 'Users', and 'Groups'. Below the tabs is a search bar labeled 'Search...'. A table lists users with columns for 'Username', 'AD User', and 'Actions'. The table contains two rows: 'admin' and 'chdevice', both with 'No' in the 'AD User' column. The 'Actions' column for each row contains three icons: a magnifying glass, a document with a pencil, and a trash can. Below the table is a pagination control showing '1' of 10 items.

Username	AD User	Actions
admin	No	[Icons]
chdevice	No	[Icons]

Use the **Search Users** field to enter search term(s) and display users that match the search criteria.

If users listed in the **Users** table span across multiple pages, navigate through the list of users by selecting a page number or by using the left or right arrows at the bottom of the **Users** pane to move forward or backward through the pages.

Each page can be set to display 5, 10, or 20 users by using the drop-down menu to the right of the navigation arrows.

Information about existing users is displayed in table format and the following details are provided for each user.

- **Username:** Displays the name of the user.
- **AD User:** Displays whether the user requires authentication using Active Directory.

Select the corresponding icon in the Actions column to view detailed user information or to delete the user.

To create a new user, select **Create User**.

Create a New Local User

1. Select **Create User** in the **Users** tab.
2. In the **Create User** dialog, enter the following:

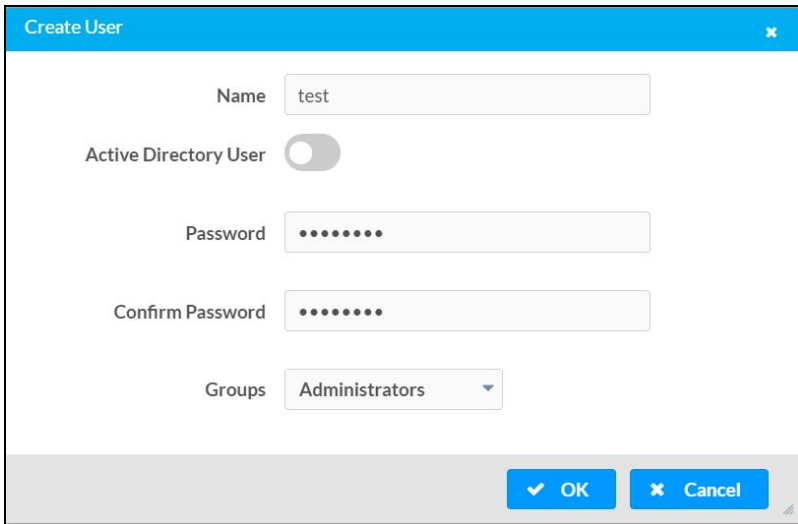

- a. Enter a user name in the **Name** field. A valid user name can consist of alphanumeric characters (letters a-z, A-Z, numbers 0-9) and the underscore "_" character.
- b. Enter a password in the **Password** field; re-enter the same password in the **Confirm Password** field.
- c. Assign the access level by selecting one or more groups from the **Groups** drop-down list.

NOTE: Make sure that the **Active Directory User** toggle is disabled.

3. Select **OK** to save or select **Cancel** to cancel the changes.

Add an Active Directory User

Users cannot be created or removed from the Active Directory server, but access can be granted to an existing user in the Active Directory server.

To grant access to an Active Directory user, you can either add the user to a local group on the DM-NAX-AUD-USB, or add the Active Directory group(s) that they are a member of to the DM-NAX-AUD-USB.

To add an Active Directory user:

1. Select **Create User**.
2. In the **Create User** dialog, enter the following.

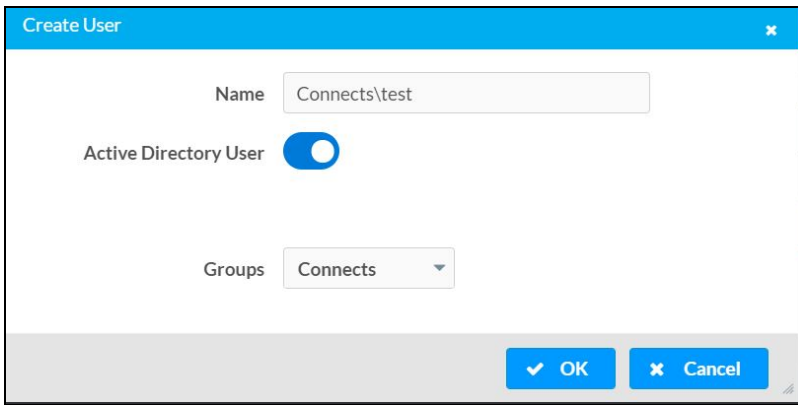

- a. Enter a user name in the **Name** field in the format "Domain\UserName", for example "crestronlabs.com\JohnSmith". Valid user names can contain alphanumeric characters (letters a-z, A-Z, numbers 0-9) and the underscore "_" character.
- b. Select one or more groups from the **Groups** drop-down list.

NOTE: Make sure that the **Active Directory User** toggle is set to enabled.

3. Select **OK** to save or select **Cancel** to cancel the changes.

Delete User

Select the trashcan icon  in the **Actions** column to delete the user. Select **Yes** when prompted to delete the user or **No** to cancel the deletion.

After a user is removed from a group, they lose any access rights associated with that group. Note that the user account is not deleted by the delete user operation.

View User Details

Select the information icon  in the **Actions** column to view information for the selected user. The **User Details** dialog displays the following information for the selected user.

- **Name:** Displays the name of the selected user.
- **Active Directory User:** Displays whether the user is an Active Directory user.
- **Group:** Displays group(s) the selected user is part of.

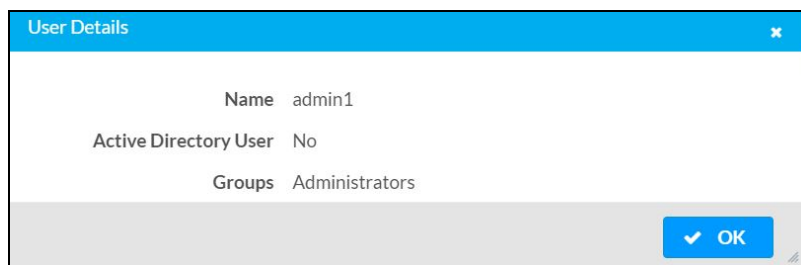

Select **OK** to close the **User Details** dialog and to return to the **Users** tab.

Update User Details

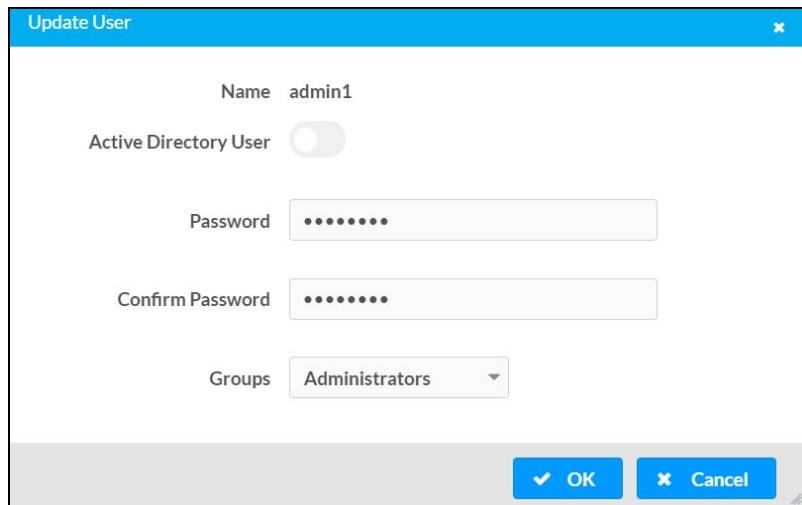

1. Select the edit icon  in the **Actions** column to update information for the selected user.
2. Enter a password in the **Password** field; re-enter the same password in the **Confirm Password** field.
3. Select one or more groups to assign the user to from the **Groups** drop-down list.
4. Select **OK** to save or select **Cancel** to cancel the changes.

The **Update User** dialog also displays the following read-only information for the selected user.









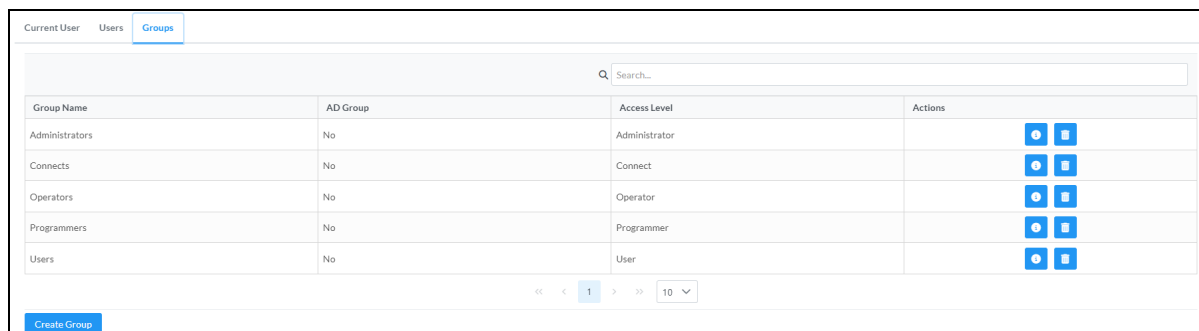

- **Name:** Displays the name of the user.
- **Active Directory User:** Displays whether the user is an Active Directory user.

Groups

Select the **Groups** tab to view and edit group settings. The **Groups** tab can be used to add local and Active Directory groups, remove local and Active Directory groups, and preview information about a group.

Use the **Search Groups** field to enter search term(s) and display groups that match the search criteria.





Group Name	AD Group	Access Level	Actions
Administrators	No	Administrator	 
Connects	No	Connect	 
Operators	No	Operator	 
Programmers	No	Programmer	 
Users	No	User	 

If groups listed in the **Groups** table span across multiple pages, navigate through the groups by selecting a page number or by using the left or right arrows at the bottom of the **Groups** pane to move forward or backward through the pages.

Additionally, each page can be set to display 5, 10, or 20 groups by using the drop-down menu to the right of the navigation arrows.

Existing groups are displayed in a table and the following information is provided for each group:

- **Group Name:** Displays the name of the group.
- **AD Group:** Displays whether the group requires authentication using Active Directory.
- **Access Level:** Displays the predefined access level assigned to the group (Administrator, Programmer, Operator, User, or Connect).

Select the corresponding icon in the **Actions** column to view detailed group information  or to delete  selected group.

Select **Create Group** in the **Groups** tab to create new group.

Create Local Group

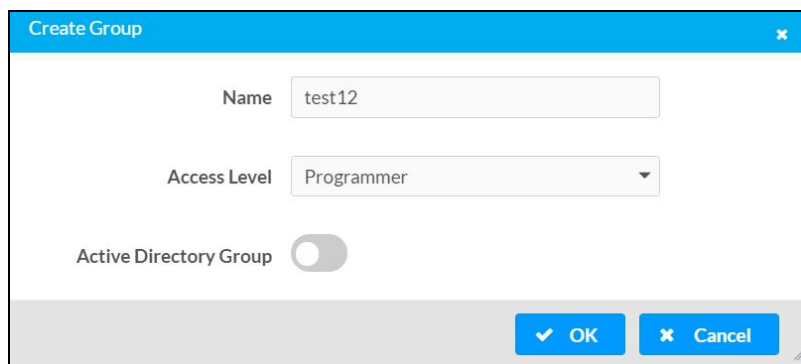

1. Select **Create Group**.
2. In the **Create Group** dialog, enter the following:
 - a. Enter the group name in the **Name** field.
 - b. Assign the group access level by selecting a predefined access level (Administrator, Connect, Operator, Programmer, User) from the **Access Level** drop-down list.

NOTE: Make sure that the **Active Directory Group** toggle is disabled.

3. Select **OK** to save. Select **Cancel** to cancel the changes.

Add Active Directory Group

A group cannot be created or removed from the Active Directory server, but access can be granted to an existing group in Active Directory.

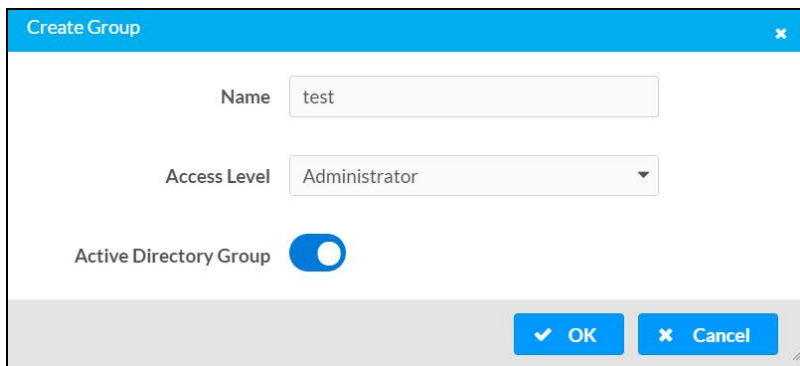

Once the group is added, all members of that group will have access to the DM-NAX-AUD-USB.

1. Select **Create Group**.
2. In the **Create Group** dialog enter the following:
 - a. Enter the group name in the **Name** field, for example "Engineering Group". Note that group names are case sensitive; a space is a valid character that can be used in group names.
3. Assign the group access level by selecting a predefined access level (Administrator, Connect, Operator, Programmer, User) from the **Access Level** drop-down list.

NOTE: Make sure that the **Active Directory Group** toggle is enabled.

4. Select **OK** to save. Select **Cancel** to cancel the changes.

Delete a Group

Select the trashcan icon  in the **Actions** column to delete a group. Select **Yes** when prompted to delete the group or **No** to cancel the deletion.

When a group is deleted, users in the group are not removed from the device or Active Directory server. However, because a user's access level is inherited from a group(s), users within the deleted group will lose access rights associated with the group.

View Group Details

Select the information icon  in the **Actions** column to view information for the selected group. The **Group Details** dialog lists the following information for the selected group.

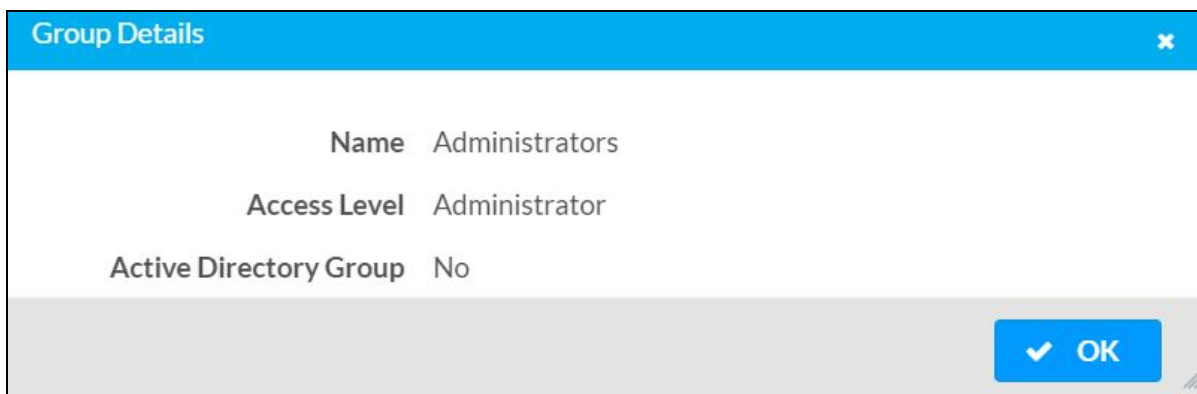

- **Name:** Displays the name of the group.
- **Access Level:** Displays the access level of the group and its users.
- **Active Directory Group:** Displays whether the group is an Active Directory group.

Select **OK** to close the **Group Details** dialog and to return to the **Groups** tab.

802.1x Configuration

The DM-NAX-AUD-USB has built-in support for the 802.1X standard (an IEEE network standard designed to enhance the security of wireless and Ethernet LANs. The standard relies on the exchange of messages between the device and the network's host, or authentication server), allowing communication with the authentication server and access to protected corporate networks.

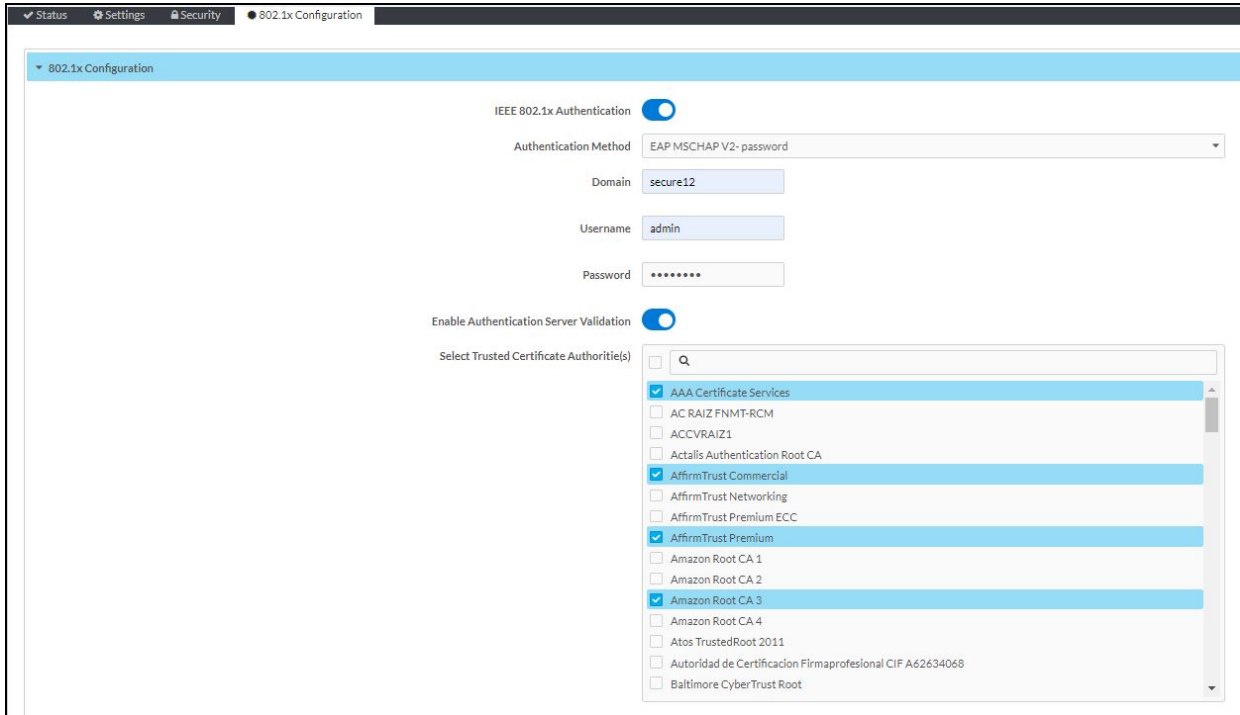

Configure DM-NAX-AUD-USB for 802.1X Authentication

1. Set the **IEEE 802.1X Authentication** toggle to enabled. This will enable all options on the 802.1X dialog.
2. Select the **Authentication method: EAP-TLS Certificate** or **EAP-MSCHAP V2 Password** according to the network administrator's requirement.
3. Do either one of the following:
 - Select **EAP-TLS Certificate**: Select **Action/Manage Certificates** to upload the required machine certificate. The machine certificate is an encrypted file that will be supplied by the network administrator, along with the certificate password.
 - Select **EAP-MSCHAP V2 Password**: Enter the username and password supplied by the network administrator into the **Username** and **Password** fields. This method does not require the use of a machine certificate, only the user name and password credentials.

4. If you enabled the **Enable Authentication Server Validation** option, this will enable the **Select Trusted Certificate Authority(ies)** list box which contains signed Trusted Certificate Authorities (CAs) preloaded into the DM-NAX-AUD-USB.

Select the check box next to each CA whose certificate can be used for server validation, as specified by the network administrator.

If the network does not use any of the listed certificates, the network administrator must provide a certificate, which must be uploaded manually via the **Manage Certificates** functionality.

5. If required, type the domain name of the network in the **Domain** field.
6. When the 802.1X settings are configured as desired, select **Save Changes** to save the changes to the device and reboot it. Select **Revert** to cancel any changes.

DM-NAX-BTIO-1G

This section describes how to configure the DM-NAX-BTIO-1G.

This section provides the following information:

- [Web Interface Configuration](#)
- [Front Panel Menu](#)
- [Access the Web Interface With the Crestron Toolbox™ Application](#)
- [Action](#)
- [Status](#)
- [Settings](#)
- [Security](#)
- [802.1x Configuration](#)

Web Interface Configuration

The DM-NAX-2XLRI-1G web interface allows you to view status information and configure network and device settings.

Access the Web Interface

To access the web interface, do either of the following:

- [Access the Web Interface with a Web Browser on page 570](#)
- [Access the Web Interface With the Crestron Toolbox™ Application on page 577](#)

The web interface is accessed from a web browser. The following table lists operating systems and their corresponding supported web browsers.

Operating System and Supported Web Browsers

OPERATING SYSTEM	SUPPORTED WEB BROWSERS
Windows® operating system	Chrome™ web browser, version 31 and later Firefox® web browser, version 31 and later Internet Explorer web browser, version 11 and later Microsoft Edge web browser
macOS® operating system	Safari® web browser, version 6 and later Chrome web browser, version 31 and later Firefox web browser, version 31 and later

Access the Web Interface with a Web Browser

1. Enter the IP address of the DM-NAX-BTIO-1G into a web browser.

NOTE: To obtain the IP address, access the front panel menu of the wall plate, use the **Device Discovery Tool** option in Crestron Toolbox™ application, or an IP scanner application.

2. If you are creating a user account for the first time, do the following; otherwise, skip to step 3.
 - a. Enter a username in the **Username** field.
 - b. Enter a password in the **Password** field.
 - c. Re-enter the same password in the **Confirm Password** field.

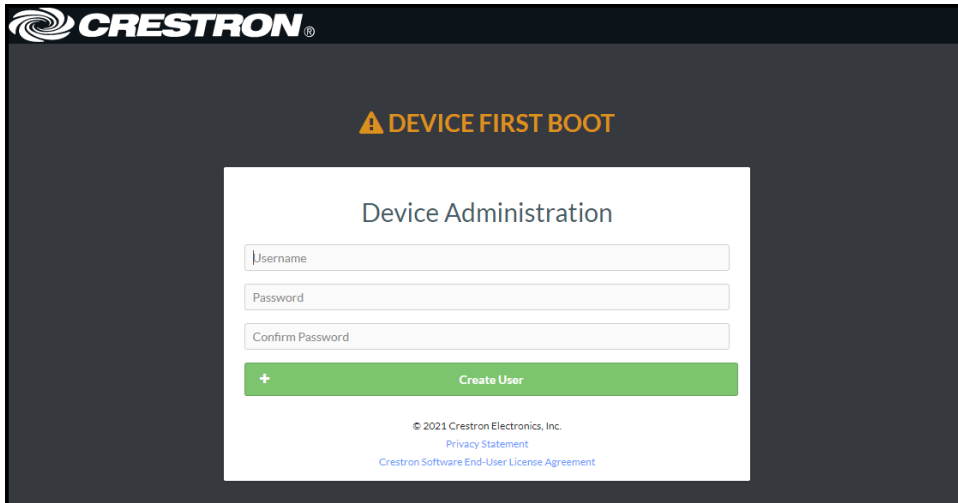

- d. Select **Create User**. The Device Administration page appears.

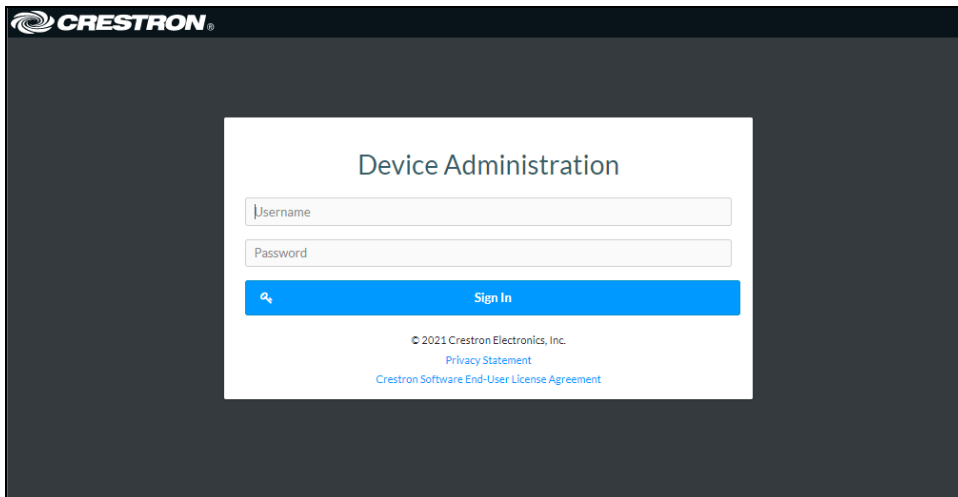





3. Enter the username in the **Username** field.
4. Enter the password in the **Password** field.
5. Select **Sign In**.



Front Panel Menu

The DM-NAX-BTIO-1G features an OLED front panel display for basic setup menus and volume control readout.

Using the Front Panel Buttons

The front panel of the DM-NAX-BTIO-1G features four push buttons for device control and menu navigation:

- The **Menu**  button opens the menu from either display standby or the home page. Once the menu is open, this button functions as a select button to select a highlighted menu item.
- The **Bluetooth® Rune**  button puts the device into pairing mode when held during display standby or from any menu page.
- The **Up**  and **Down**  buttons increase and decrease the volume of the connected Bluetooth device (respectively) while the display is in standby or on the home page. Once the menu is open, these buttons navigate up and down the list of menu items, respectively.

NOTE: The **Up**  and **Down**  buttons will require programming to control volume levels when the DM-NAX-BTIO-1G is added to a SIMPL Windows program. Refer to [Online Help Article 3059](#) for programming information.

The front panel display will enter standby after an interval determined by the **Standby Timeout** setting in the web interface. Refer to [Commercial Mode on page 586](#) or [Residential Mode on page 605](#) for information on configuring **Standby Timeout**. If the display is in standby, pressing any front panel button will wake it.

Front Panel Pages - Receiver Mode

NOTE: The images in this section are representations of the pages that will appear when the wall plate is in **Receiver** mode. The text of the displayed pages will vary depending on settings, connected devices, and active media.

Starting Up

When the device is booting, the front panel display will show a Crestron swirl logo for approximately two minutes, followed by a temporary **STARTING UP** page.

Starting Up Page



Home Page

The home page appears when the wall plate finishes booting, is woken up from standby, or when the menu pages are closed.

If no Bluetooth devices are paired with the wall plate, the home page displays a readout of the current Bluetooth mode (**Receiver** or **Transmitter**), a Bluetooth Rune logo, and the Bluetooth name by which the device is discoverable.

Sample Home Page - No Device Connected



Sample Home Page - Ready



Sample Home Page - Paused



Sample Home Page - Audio Playing



Pairing Devices

When the **Bluetooth Rune**  button is held, two pages appear in succession. The first is an instruction to keep holding the button to initiate pairing discovery. After several seconds, the second page is a status message that the wall plate is discoverable.

Sample Pairing Page - Hold to Pair





Sample Pairing Page - Discoverable



Once pairing is complete, the device will return to the home page.

When a device is paired, the home page will display available metadata from currently playing audio or a message relating to the status of the connected device, as well as the name of the connected device.

Clearing Devices

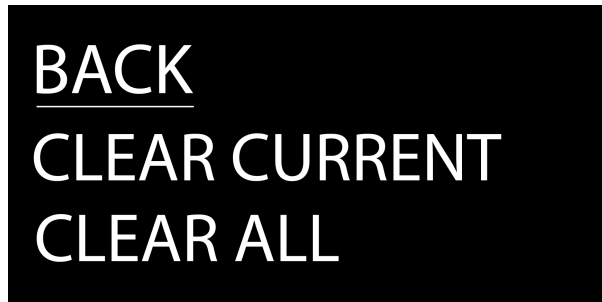

Hold the **Bluetooth Rune**  and **Down**  buttons simultaneously for 5 seconds to access a menu with functions for clearing paired devices.

Clear Devices Page



- Select **CLEAR CURRENT** to forget the actively transmitting device.
- Select **CLEAR ALL** to forget all paired devices.
- Select **BACK** to return to the home page.

Volume Control

The volume of the incoming audio is controlled either using the volume buttons on the casting device or the **Up**  and **Down**  buttons on the front panel. When a volume adjustment is made, the **Bluetooth Volume** page is displayed on the front panel.

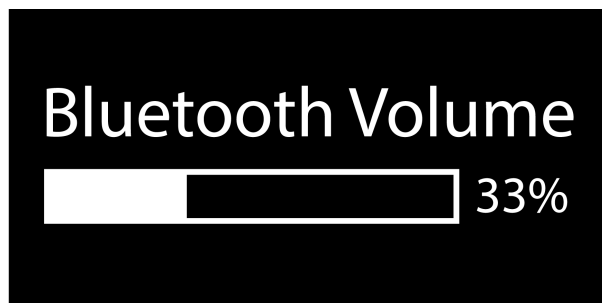

Sample Bluetooth Volume Page



After several seconds of inactivity, the front panel display will return to the home page.

Menu Pages

Press the **Menu** button  to access the menu pages. Once the menu pages are displayed, the **Menu** button functions as a select button instead.

The IP address of the wall plate is displayed at the top of the menu, followed by the available menu functions. The current menu function selection is underlined. Using the **Up**  and **Down**  buttons, choose between **BACK** to return to the home page or **SET TRANSMITTER** to switch the wall plate into transmitter mode.

NOTE: Transmitter mode is currently a beta feature and should only be used for testing purposes.

Sample Menu Page

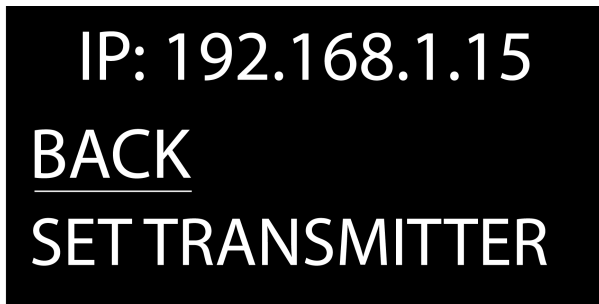

After selecting **SET TRANSMITTER**, a status page is briefly displayed indicating that the device is switching to transmitter mode, followed by the temporary **STARTING UP** page.

Setting to Transmit Mode Page

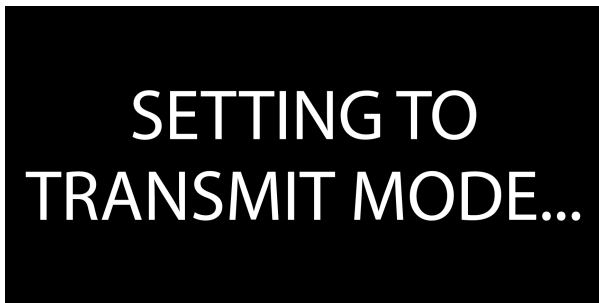

Access the Web Interface With the Crestron Toolbox™ Application

To access the web interface by opening a web browser within the Crestron Toolbox™ application:

1. Open the Crestron Toolbox application.
2. From the **Tools** menu, select **Device Discovery Tool**. You can also access the Device Discovery Tool by selecting the Device Discovery Tool icon  in the Crestron Toolbox toolbar. The DM-NAX-BTIO-1G is discovered and listed in the device list on the left side of the screen. The associated host name, IP address, and firmware version are also displayed.

NOTE: If there is security software running on the computer, a security alert might be displayed when the Crestron Toolbox application attempts to connect to the network. Make sure to allow the connection, so that the Device Discovery Tool can be used.

3. In the Device Discovery Tool list, select the device.
4. Enter the device credentials in the **Authentication Required** dialog that opens, then select **Log In**.
5. Select **Web Configuration**.

Action

The **Action** drop-down menu is displayed at the top right side of the interface and provides quick access to common device functions:

- [Save Changes on page 578](#)
- [Revert on page 578](#)
- [Reboot on page 579](#)
- [Restore to Factory Default Settings on page 579](#)
- [Update Firmware on page 579](#)
- [Download Logs on page 580](#)
- [Manage Certificates on page 580](#)

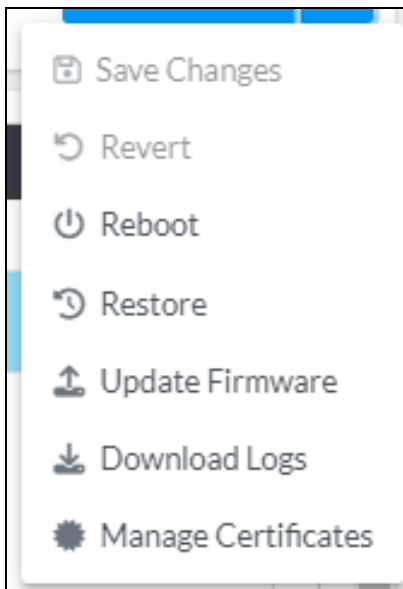

Save Changes

Select **Save Changes** to save any changes made to the configuration settings.

Revert

Select **Revert** to revert the device back to the last saved configuration settings.

Reboot

Certain changes to the settings may require the DM-NAX-BTIO-1G to be rebooted to take effect. To reboot the device:

1. Select **Reboot** in the **Action** drop-down menu. The **Confirmation** message box appears.

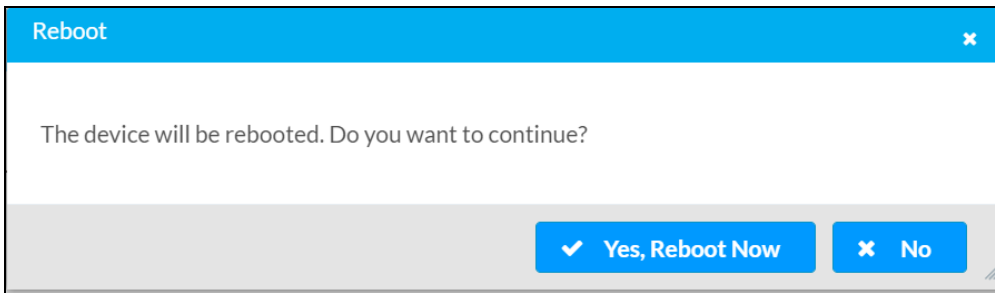

2. Select **Yes, Reboot Now** to reboot the device. The **Reboot** message box appears. Wait for the device reboot to complete before attempting to reconnect to the device.

Restore to Factory Default Settings

1. Select **Restore** in the **Action** drop-down menu to restore the settings of the DM-NAX-BTIO-1G to factory defaults.

NOTE: When settings are restored, all settings, including the network settings, will revert to the factory default. If a static IP address is set, restoring the device to factory default settings will revert the IP address to the default DHCP mode.

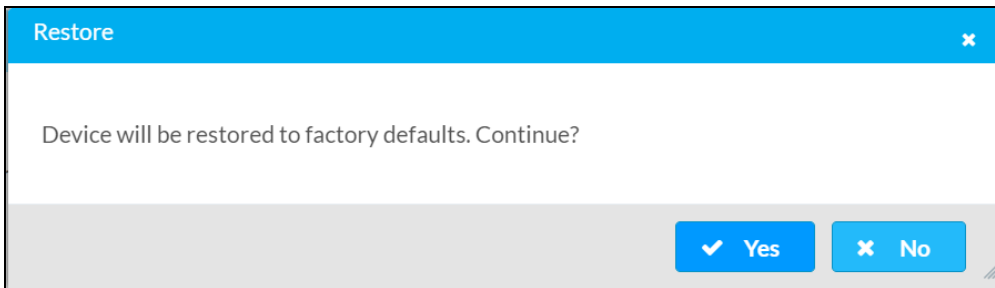

2. Select **Yes** in the **Confirmation** dialog to restore the DM-NAX-BTIO-1G to factory settings. Select **No** to cancel the restore operation.

A dialog is displayed again, indicating that the restore process was successful and that the device rebooted.

You can also restore to factory settings by pressing and holding the **SETUP** button on the rear panel of the device with power disconnected then connect the power supply and continue to hold **SETUP** button for 30 seconds.

Update Firmware

1. Select **Update Firmware** in the **Action** drop-down menu.
2. In the **Firmware Upgrade** dialog, select **+ Browse**.

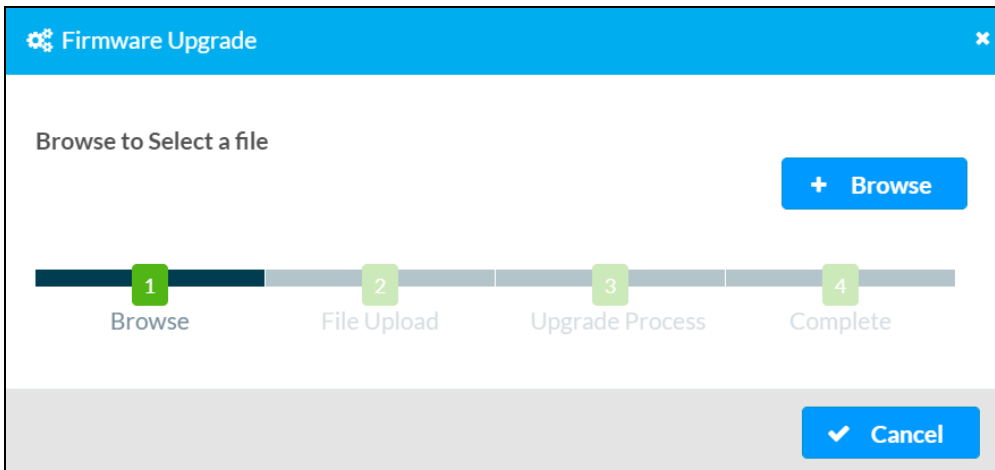

3. Locate and select the desired firmware file, then select **Open**. The selected firmware file name is displayed in the **Firmware Upgrade** dialog.
4. Select **Load** and wait for the progress bar to complete and for **OK** to become selectable.
5. Select **OK**. The device with new firmware can now be accessed.

Download Logs

Select **Download Logs** in the **Action** drop-down menu to download the device message logs for diagnostic purposes.

The log file is downloaded to the Downloads folder of the PC.

Manage Certificates

Use the **Manage Certificates** dialog to add, remove, and manage certificates used in 802.1x and other protected networks.

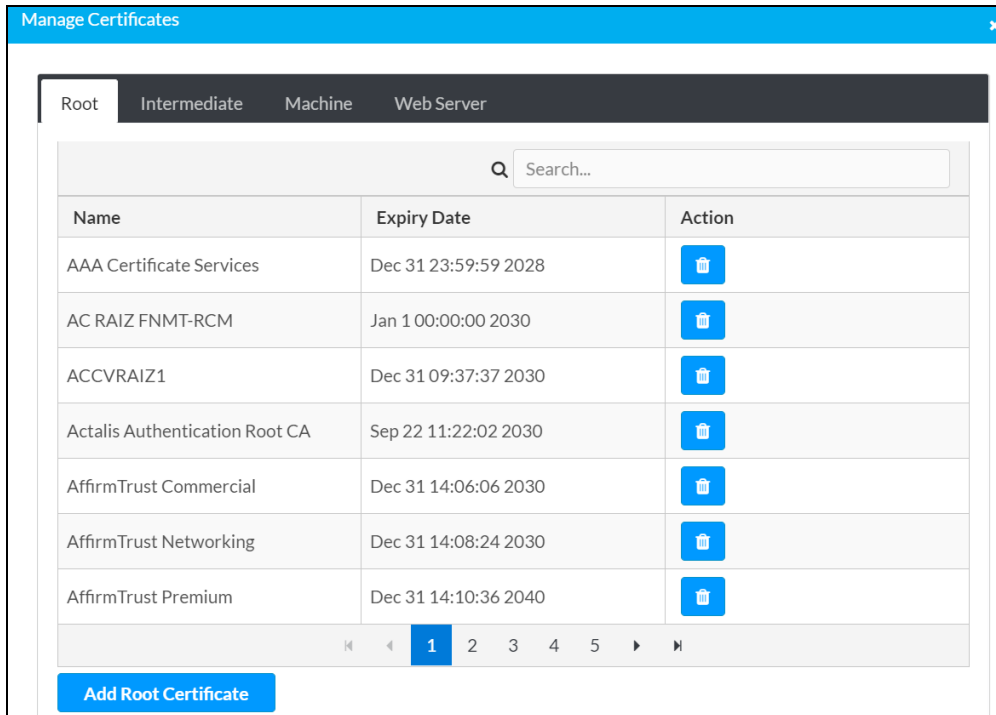

Select **Manage Certificates** in the **Action** drop-down menu. The following certificate tabs are displayed:

- **Root:** The Root certificate is used by the DM-NAX-BTIO-1G to validate the network's authentication server. The DM-NAX-BTIO-1G has a variety of Root certificates, self-signed by trusted CAs (Certificate Authorities) preloaded into the device. Root certificates must be self-signed.
- **Intermediate:** The Intermediate store holds non self-signed certificates that are used to validate the authentication server. These certificates will be provided by the network administrator if the network does not use self-signed Root certificates.
- **Machine:** The machine certificate is an encrypted PFX file that is used by the authentication server to validate the identity of the DM-NAX-BTIO-1G. The machine certificate will be provided by the network administrator, along with the certificate password. For 802.1x, only one machine certificate can reside on the device.
- **Web Server:** The Web Server certificate is a digital file that contains information about the identity of the web server.

To Add Certificates

1. Select the corresponding certificate tab.
2. Select **Add Root Certificate**.
3. Select **+ Browse**.
4. Locate and select the file, then select **Open**.

NOTE: If the certificate is a Machine Certificate, enter the password provided by the network administrator.

5. Select **OK**. This will add the certificate to the list box, displaying the file name and expiration date. The certificate is now available for selection and can be loaded to the device.

To Delete Certificates

1. Select the corresponding certificate tab.
2. Select the delete icon  in the **Actions** column to delete the certificate.
3. Select **Yes** when prompted to delete the certificate or **No** to cancel the deletion.

Status

The **Status** page is the first page displayed when opening the interface of the DM-NAX-BTIO-1G. It displays general information about the DM-NAX-BTIO-1G (such as **Model Name**, **Firmware Version**, and **Serial Number**), current network settings (such as **Host Name** and **IP Address**, etc.), and input and output ports' current status.

The **Status** page can be accessed at any time by selecting the **Status** tab of the DM-NAX-BTIO-1G interface.

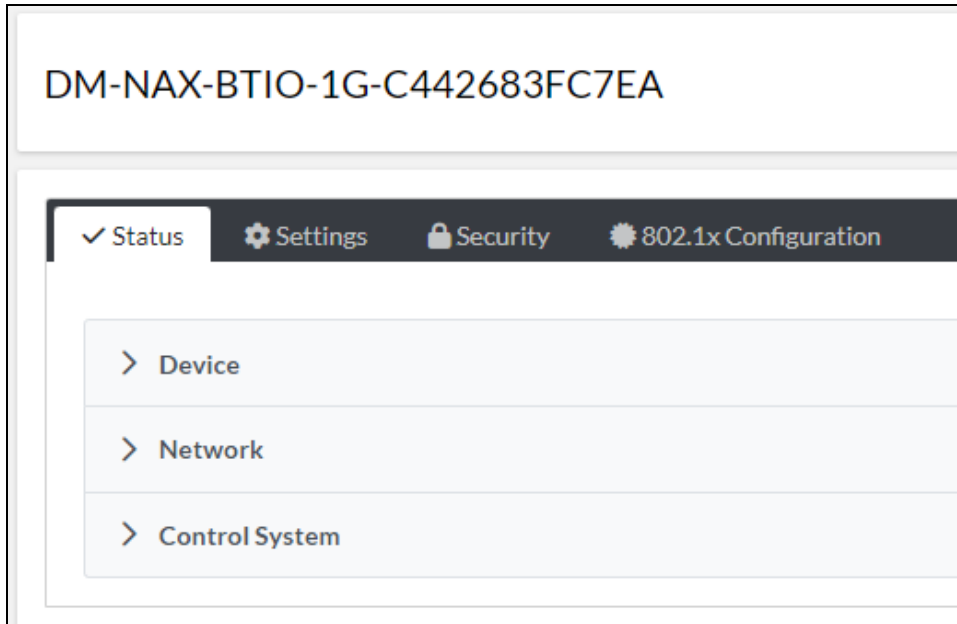

Information displayed on the **Status** tab is organized into different sections.

Device

The **Device** section displays the **Model**, **Firmware Version**, and **Serial Number** of the DM-NAX-BTIO-1G.

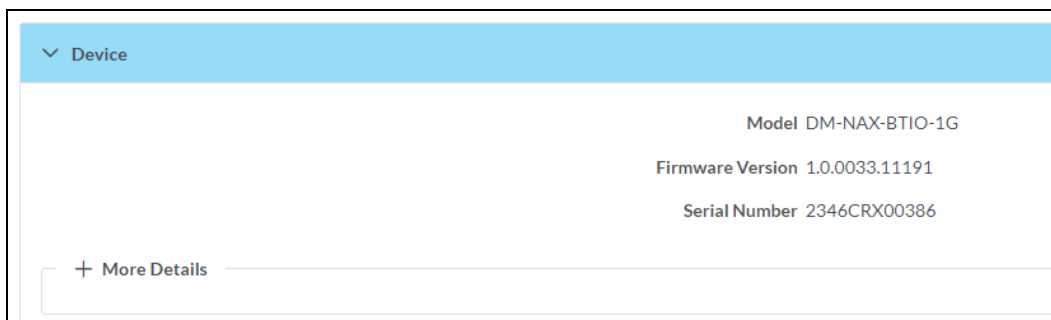

Select **+ More Details** to review additional information about the DM-NAX-BTIO-1G.

More Details	
DM-NAX-BTIO-1G	1.0.0033.11191
Build	Feb 13 2024 (531246)
Updater	1.0.0033.11191
Bootloader	1.00.00
CCUI Version	1.1327.1
XIOSDK	3.8.2
IoTSDK	1.11.0
Build time	11:19:07
Product ID	0x7A09
Revision ID	0x0200
HDCP2X-SKE	
HDCP2X-SKE	HDCP2X-SKE [v9.0000.00000,#FFFFFFFF]
PRE-BOOT	[v9.0000.00000]
BOOTLOADER	[v9.0000.00000]
ctrl-extclk-in-pps	Driver v1.1
ctrl-prod-info	Driver v3.0
ctrl-io-bt	FW v2.0.98
PUF	1.0.0033.11191
Forced Auth Mode	True

Network

The **Network** section displays network-related information about the DM-NAX-BTIO-1G, including the Hostname, Domain Name, and DNS Servers.

Network	
Hostname	DM-NAX-BTIO-1G-C442683FC7EA
Domain Name	CRESTRON.CRESTRON.com
DNS Servers	10.64.5.10(DHCP)
Adapter 1	
DHCP	On
IP Address	10.64.68.175
Subnet Mask	255.255.255.0
Default Gateway	10.64.68.1
Link Active	true
MAC Address	c4.42.68.3f.c7.ea

NOTE: By default, the host name of the DM-NAX-BTIO-1G consists of the model name followed by the MAC address of the device. For example, DM-NAX-BTIO-1G-00107FB58088.

Select **+ Adapter 1** to display an expanded section that shows additional information. If **+ Adapter 1** is selected, select **- Adapter 1** details to collapse the section.

Control System

The **Control System** section displays connection information, consisting of the following:

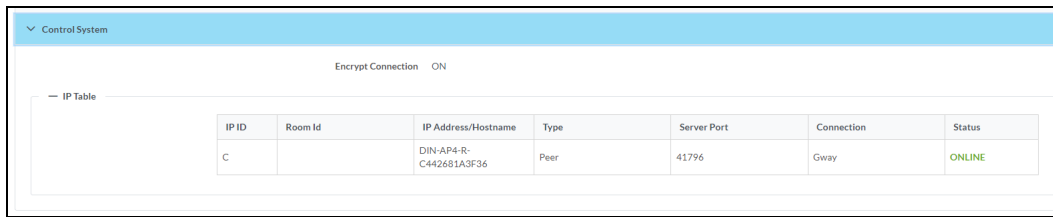

The screenshot shows a web interface for the Control System. At the top, there is a blue header with a dropdown arrow and the text "Control System". Below the header, the text "Encrypt Connection ON" is displayed. Underneath, there is a section titled "IP Table" which contains a table with the following data:

IP ID	Room Id	IP Address/Hostname	Type	Server Port	Connection	Status
C		DIN-AP4-R- C442681A3F36	Peer	41796	Gway	ONLINE

- **Encrypt Connection:** ON or OFF
- **IP ID:** Reports the currently used IP ID of the DM-NAX-BTIO-1G
- **IP Address/Hostname:** The IP address of the control system
- **Room ID:** Displays the room ID
- **Status:** OFFLINE or ONLINE

Settings

The **Settings** page enables configuration of the DM-NAX-BTIO-1G settings. The **Settings** page can be accessed at any time by selecting the **Settings** tab of the DM-NAX-BTIO-1G interface.

Many options in the **Settings** page are exclusive to a specific device mode: Residential or Commercial. The DM-NAX-BTIO-1G is in Commercial mode by default.

This section provides the following information:

- [Commercial Mode on page 586](#)
- [Residential Mode on page 605](#)

Commercial Mode

The **Settings** page enables you to configure the DM-NAX-BTIO-1G settings. The **Settings** page can be accessed at any time by selecting the **Settings** tab of the DM-NAX-BTIO-1G interface.

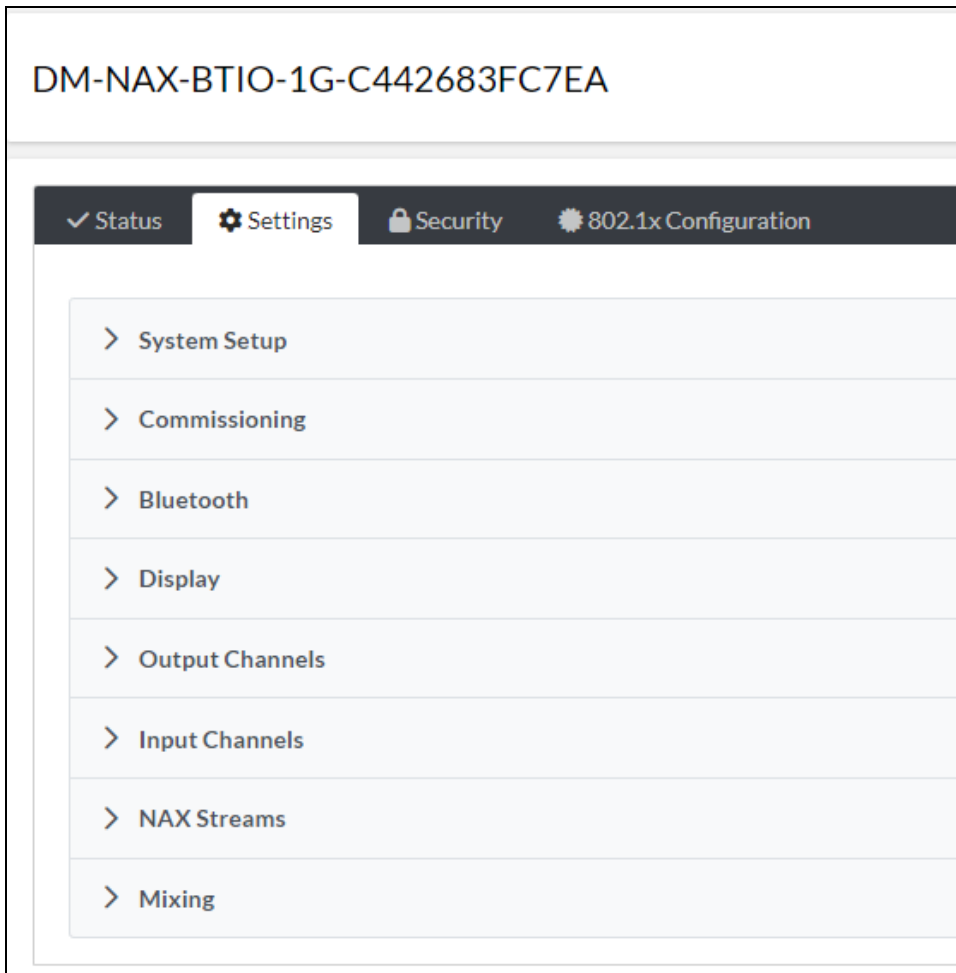

Settings available on the **Settings** page are organized into different sections.

System Setup

The **System Setup** section contains settings for **Date/Time**, **Auto Update**, **Network**, and **Control System**.

System Setup

Date/Time | Auto Update | Network | Control System | Cloud Settings | Device Modes

— Date/Time

Synchronization

Time Synchronization

[Synchronize Now](#)

NTP Time Servers

<input type="checkbox"/>	Address	Port	Authentication Method	Authentication Key	Key ID
<input type="checkbox"/>	pool.ntp.org	123	None	*****	0

[+ Add](#) [- Remove](#)

Configuration

Time Zone: (UTC-05:00) Eastern Time (US & Can) ▼

Date: 02/27/2024

Time: 17:14

Date/Time

Use the **Date/Time** tab to configure the date and time settings of the DM-NAX-BTIO-1G.

— Date/Time

Synchronization

Time Synchronization

[Synchronize Now](#)

NTP Time Servers

<input type="checkbox"/>	Address	Port	Authentication Method	Authentication Key	Key ID
<input type="checkbox"/>	pool.ntp.org	123	None	*****	0

[+ Add](#) [- Remove](#)

Configuration

Time Zone: (UTC-05:00) Eastern Time (US & Can) ▼

Date: 02/21/2024

Time: 12:40

Time Synchronization

1. Set the **Time Synchronization** toggle to the right position to enable or left position to disable time synchronization. By default, time synchronization is enabled.
2. In the **NTP Time Servers** table, enter the URL of a NTP (Network Time Protocol) or SNTP (Simple Network Time Protocol) server. Up to three time servers can be added on a device.
3. Select **Synchronize Now** to perform time synchronization between the device's internal clock and the time server.

Time Configuration

1. Open the **Time Zone** drop-down menu to select the applicable time zone.
2. In the **Date** field, enter the current date.
3. In the **Time (24hr Format)** field, enter the current time in 24-hour format.

Select **Save Changes** to save the settings.

Select **Revert** from the **Action** drop-down menu to revert to the previous settings without saving.

Auto Update

The DM-NAX-BTIO-1G can automatically check for and install firmware updates at scheduled intervals via the Auto Update feature.

Auto Update

Auto Update

Custom URL

Custom URL Path

Schedule

Day of Week

Time of Day

Poll Interval Minutes

1. Set the **Auto Update** toggle to the right position to enable Auto Update.
2. Define the URL to download the updates by doing either of the following:
 - a. Use the default URL to download the updates from the Crestron server.
 - b. Use a custom URL. Set the **Custom URL** toggle to the right position to enable a custom URL. In the **Custom URL Path** text box, enter the path to a custom manifest file in the FTP or SFTP URL format. Use the Crestron Auto Update Tool to generate a custom manifest file, then store the file on an FTP (File Transfer Protocol) or SFTP (Secure File Transfer Protocol) server.
3. Set a schedule for the automatic firmware update by doing either of the following:
 - a. Select the desired **Day of Week** and **Time of Day** (24-hour format) values.
 - b. Set the **Poll Interval** by entering a value from **60** to **65535** minutes. A value of **0** disables the Poll Interval.
4. Select **Save Changes**.

Selecting **Update Now** causes the device to check for a firmware update immediately. If a schedule was set in step 4 above, that schedule still remains in effect.

Network

The **Network** tab contains network-related settings for the DM-NAX-BTIO-1G, including the Hostname, Domain, Primary Static DNS, and Secondary Static DNS.

The screenshot shows the Network configuration page for the DM-NAX-BTIO-1G device. The page has a navigation bar at the top with tabs for Date/Time, Auto Update, Network (selected), Control System, Cloud Settings, and Device Modes. Below the navigation bar, there is a subheading for "Network" and a subheading for "Adapter 1". The settings are as follows:

Setting	Value
Hostname *	DM-NAX-BTIO-1G-C442683FC7EA
Domain	CRESTRON.CRESTRON.com
Primary Static DNS	10.64.5.10(DHCP)
Secondary Static DNS	192.168.200.133(DHCP)
DHCP Enabled	<input checked="" type="checkbox"/>
IP Address	10.64.68.175
Subnet Mask	255.255.255.0
Default Gateway	10.64.68.1

NOTE: By default, the hostname of the DM-NAX-BTIO-1G consists of the model name followed by the MAC address of the device. For example, DM-NAX-BTIO-1G-00107FB58088.

Adapter 1

The Adapter 1 subheading contains settings for DHCP, IP Address, Subnet Mask, and Default Gateway of Ethernet adapter 1 on the rear panel of the device.

NOTE: DM NAX devices' internal processes use IP addresses in the 10.10.10.xxx range. This IP range should be avoided when addressing DM NAX devices to prevent conflicts.

Set the **DHCP** toggle to enabled (right) or disabled (left) to specify whether the IP address of the DM-NAX-BTIO-1G is to be assigned by a DHCP (Dynamic Host Configuration Protocol) server.

- **Enabled:** When DHCP is enabled (default setting), the IP address of the DM-NAX-BTIO-1G is automatically assigned by a DHCP server on the local area network (LAN).
- **Disabled:** When DHCP is disabled, manually enter information in the following fields:
 - **Primary Static DNS:** Enter a primary DNS IP address.
 - **Secondary Static DNS:** Enter a secondary DNS IP address.
 - **IP Address:** Enter a unique IP address for the DM-NAX-BTIO-1G.
 - **Subnet Mask:** Enter the subnet mask that is set on the network.
 - **Default Gateway:** Enter the IP address that is to be used as the network's gateway.

To save any new network entries, select **Save Changes**.

Control System

IP ID	IP Address/Hostname	Room Id
C	DIN-AP4-R-C442681A3F36	Room Id

1. Select **Encrypt Connection** to navigate to the **Security** tab to configure encryption settings.
 - a. Enter the username in the **Control System Username** field.
 - b. Enter the password in the **Control System Password** field.
2. Select **+ Add** to add an IP table entry to the **IP Table**.
 - a. Enter the Room ID in the **Room ID** field.
 - b. Enter the IP ID of the DM-NAX-BTIO-1G in the **IP ID** field.
 - c. Enter the IP address or hostname of the control system in the **IP Address/Hostname** field.
3. Select **Save Changes** to save the new entries. The **Control System Save** message box appears, indicating that the control system settings were saved successfully. Select **Revert** to revert to the previous settings without saving.

Cloud Settings

Set the **Cloud Settings** toggle to enabled (right) or disabled (left) to specify whether the DM-NAX-BTIO-1G can communicate with the XiO Cloud® platform.

Device Modes

Use the **Device Modes** tab to configure the **Application Mode** of the DM-NAX-BTIO-1G.

Application Mode: Commercial (Advanced)

Application Mode determines which options and controls are available.

- Select **Residential (Standard)** or **Commercial (Advanced)**. A **Reboot** confirmation message box appears.

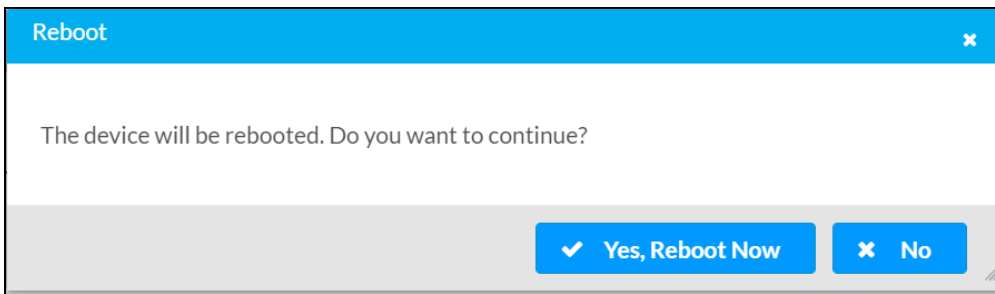

- Select **Yes, Reboot Now** to reboot the device into the selected mode. The **Reboot** message box appears.
- Wait for the device reboot to complete before attempting to reconnect to the device.

By default, the DM-NAX-BTIO-1G is set to **Commercial (Advanced)** mode.

Commissioning

The **Commissioning** section provides a quick way to automatically assign multicast addresses to the device's internal audio-over-IP stream transmitters.

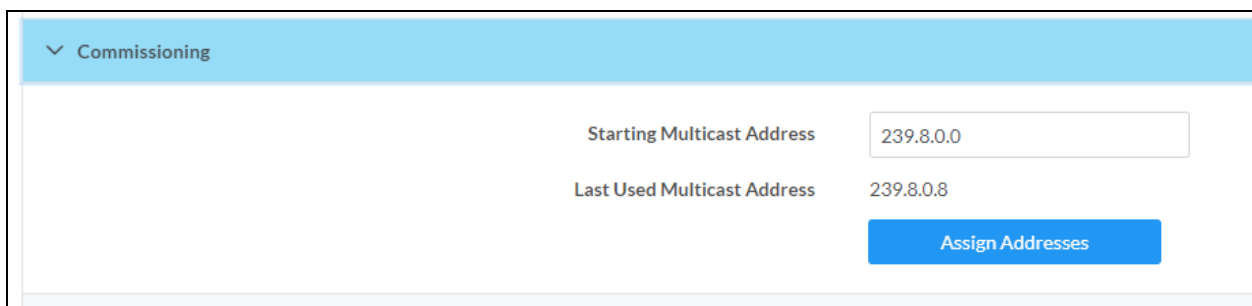

Select **Assign Addresses** to give each DM NAX transmitter in the DM-NAX-BTIO-1G a unique multicast address beginning with the specified **Starting Multicast Address**. The valid range for **Starting Multicast Address** is 239.8.0.0 to 239.255.255.254.

NOTE: This will begin transmitting multicast traffic on your network. Refer to [Audio-over-IP Network Design on page 632](#) for details on proper audio-over-IP network management.

Bluetooth Settings

The **Bluetooth** section provides settings for the internal Bluetooth radio of the DM-NAX-BTIO-1G. These settings are divided up into two tabs, labeled **Main** and **Advanced**.

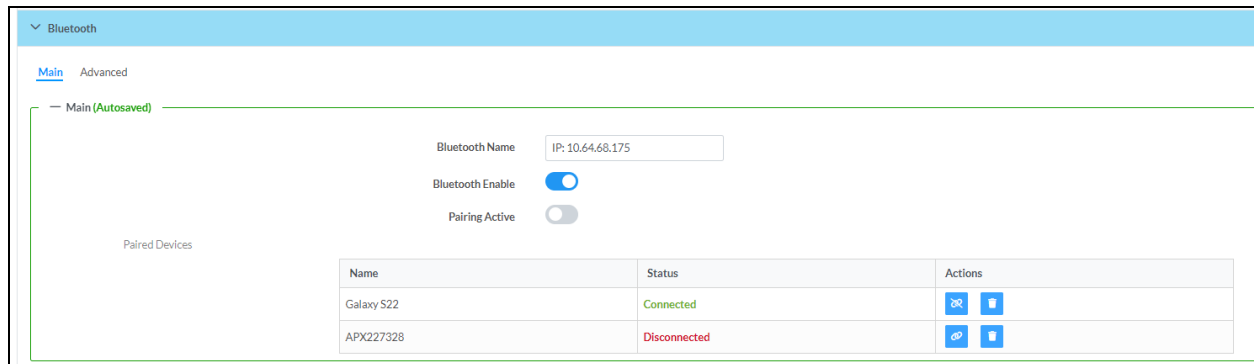

Main Bluetooth Settings



To configure the settings on the **Main** tab of the Bluetooth settings section:

- Enter a custom name for the DM-NAX-BTIO-1G in the **Bluetooth Name** text field. This is the name that will be displayed on source devices (such as smartphones) that discover the DM-NAX-BTIO-1G as a casting destination.
- Set the **Bluetooth Enable** toggle to the right to allow Bluetooth wireless audio casting to the DM-NAX-BTIO-1G. Set the **Bluetooth Enable** toggle to the left to disable Bluetooth wireless audio.

NOTE: While Bluetooth audio is disabled on the device, some applications that scan for Bluetooth devices may still be able to detect the DM-NAX-BTIO-1G. These applications will not be able to connect to the DM-NAX-BTIO-1G or cast audio to it while Bluetooth audio is disabled.

- Set the **Pairing Active** toggle to the right to enable pairing mode, allowing Bluetooth devices to pair to the DM-NAX-BTIO-1G. Set the **Pairing Active** toggle to the left to disable pairing mode.
- The **Paired Devices** table displays the name and status of all remembered Bluetooth devices that were previously paired with the DM-NAX-BTIO-1G.
 - The DM-NAX-BTIO-1G can remember up to seven previously paired devices.
 - Only one paired Bluetooth device can have a **Connected** status at a time. All other paired devices will display a **Disconnected** status. The **Connected** status indicates which device is currently able to actively cast media to the wall plate.
 - To disconnect a connected device, select the disconnect icon .
 - To forget a remembered device from the **Paired Devices** table, select the trashcan icon .

Advanced Bluetooth Settings

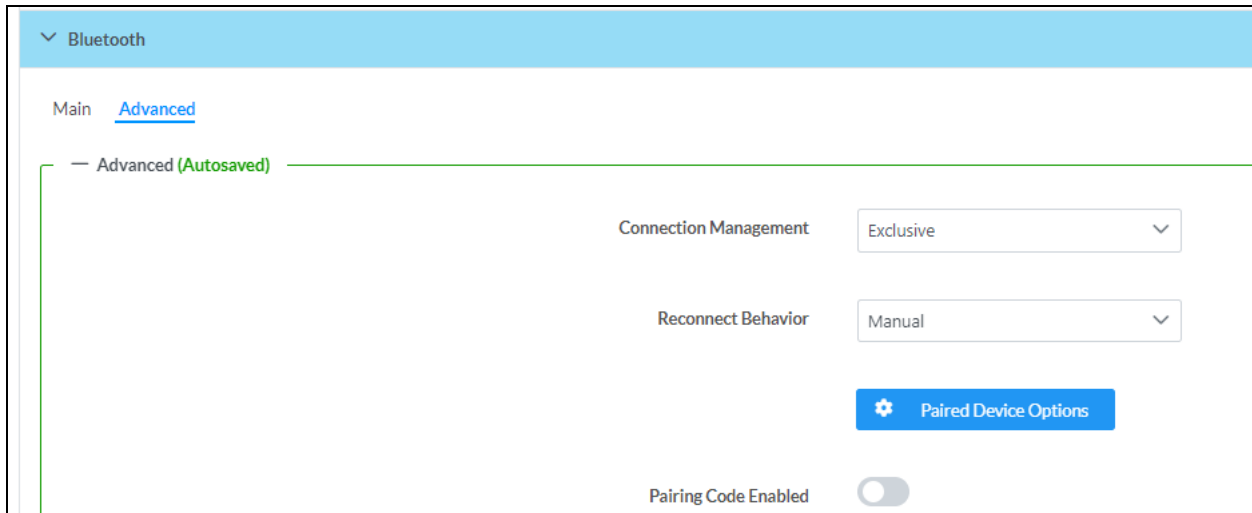

To configure the settings on the **Advanced** tab of the Bluetooth settings section:

- Select a **Connection Management** option from the drop-down. **Exclusive** mode is selected by default.
 - In **Interrupt** mode, remembered paired devices can reconnect to the DM-NAX-BTIO-1G from their Bluetooth connections list, and will interrupt any currently playing audio. The most recent casting device to select the DM-NAX-BTIO-1G from its Bluetooth list will show a **Connected** status in the **Paired Devices** table, and all other devices will revert to **Disconnected**.
 - In **Exclusive** mode, remembered paired devices cannot be reconnected to the DM-NAX-BTIO-1G from their Bluetooth connections list until the currently **Connected** device is disconnected. The device that is listed as **Connected** in the **Paired Devices** table will remain as the **Connected** device until it is disconnected by programming, from the web interface, or by the casting device itself.
 - **Temporary** mode is the same as **Exclusive** mode, with the added behavior that the DM-NAX-BTIO-1G will forget the currently connected device once it is disconnected.
- Select a **Reconnect Behavior** option from the drop-down. **Manual** is selected by default.
 - **Manual** reconnection means that any time the Bluetooth casting device is disconnected from the DM-NAX-BTIO-1G, it can only be reconnected by selecting the casting device from the DM NAX device's list of paired devices. This is the recommended setting for any system with multiple paired transmitting devices or multiple DM-NAX-BTIO-1G devices within range of each other.
 - **Automatic** reconnection means that any remembered paired Bluetooth casting device will reconnect to the DM-NAX-BTIO-1G when it is within the wireless range of the DM NAX device.

- Select **Paired Device Options** to open a **Paired Device Options** window. Select a command from the drop-down menu, then select **Send** to issue the command to the DM NAX device.
 - **Release All Paired Devices:** Disconnects all currently paired devices from the DM-NAX-BTIO-1G.
 - **Release Inactive Paired Devices:** Disconnects any paired device that is not actively playing any media.
 - **Forget All Paired Devices:** Deletes all currently paired devices from the **Paired Devices** table of the DM-NAX-BTIO-1G.
 - **Forget Inactive Paired Devices:** Disconnects and forgets any paired device that is not actively playing any media.
 - **Forget Connected Devices:** Disconnects and forgets only the current **Connected** device.
- Set the **Pairing Code Enabled** toggle to the right to enable the pairing code feature. When this is enabled, a pairing code string will populate on both the casting device and the OLED display of the DM-NAX-BTIO-1G during pairing. Confirm that the code matches on each device to complete the pairing process. Set the toggle to the left to disable the pairing code feature. The pairing code feature is disabled by default.

Display

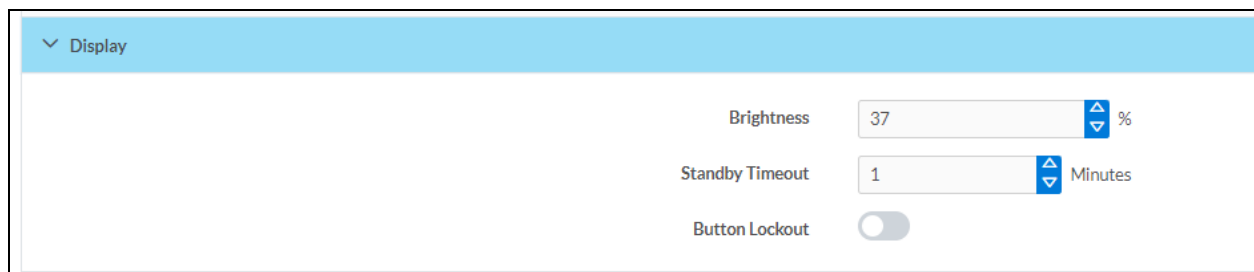

The **Display** section contains settings that affect the front panel OLED display of the DM-NAX-BTIO-1G.

- To adjust the display brightness:
 - Use the **%** arrows to increase or decrease the brightness. Values range from 0 to 100%, adjustable in increments of 1%.
 - Manually enter a percentage value in the **Brightness** text field.
- To adjust the display standby timeout:
 - Use the **Minutes** arrows to increase or decrease the brightness. The default timeout value is one minute.
 - Manually enter a value in the **Standby Timeout** text field.
- Set the **Button Lockout** toggle to the right to lock out the front panel buttons on the DM-NAX-BTIO-1G. Set the **Button Lockout** toggle to the left to disable the lockout.

Output Channels

The **Zones** section contains the **Volume** and **Mute** settings for all zone outputs of the device, as well as an **Edit** option for more advanced settings within each zone.

Output Channels								
Zones (Autosaved)								
Global Filter								
Name	LineOutLeft	LineOutRight	BTOutLeft	BTOutRight	StreamOut1Ch1	StreamOut1Ch2	StreamOut2Ch1	StreamOut2Ch2
Volume (%)								
Signal Presence								
Signal Level								
Mute	<input type="checkbox"/>	<input type="checkbox"/>	<input type="checkbox"/>	<input type="checkbox"/>	<input type="checkbox"/>	<input type="checkbox"/>	<input type="checkbox"/>	<input type="checkbox"/>
Action								

Signal Presence indicates whether or not an audio signal is detected in that zone.

Signal Level indicates if the signal is **Clipping** or **Nominal** (non-clipping).

- **Nominal:** The signal level is within normal operating bounds and below the clipping threshold.
- **Clipping:** The signal level is clipping or above the -3 dB warning threshold and in danger of clipping.

Give each zone a friendly name using the **Name** column of the **Zones** table. If the device is paired with a control system, these names may be overwritten by the control system's program.

To configure the zone volume, do one of the following:

- Move the **Volume** slider up to increase or down to decrease the zone volume.
- Use the **%** arrows to increase or decrease the zone volume. Values range from 0 to 100%, adjustable in increments of 1%.
- Manually enter a value in the **Volume** field.

To mute all audio output from a zone, select its respective **Mute**. To unmute the zone, select the **Muted**.

Select **Edit** to view additional **Zone** and **Output** options.

Zone Settings

To configure the settings for an output channel, select **Edit**. The **Edit Zone** window appears.

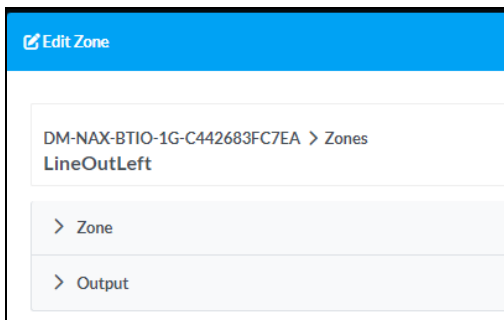

Zone

Select **Zone** to access the settings for **Delay**.

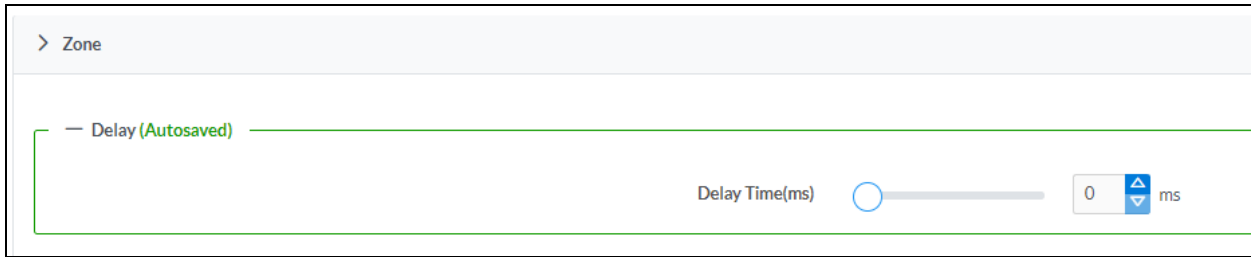

Delay

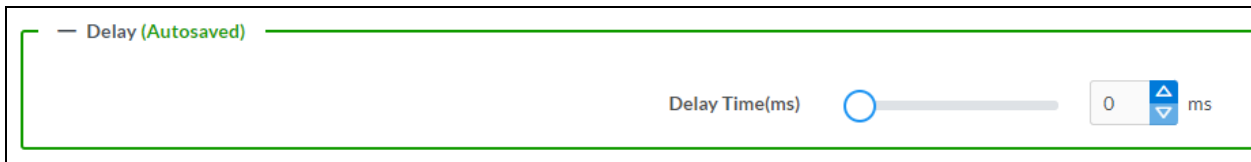

To set the delay, do one of the following:

- Move the **Delay Time(ms)** slider to the right to increase or to the left to decrease the delay time.
- Use the **ms** arrows to increase or decrease the delay. Values range from 0 ms to 85 ms, adjustable in increments of 1 ms.
- Manually enter a value in the **Delay Time(ms)** field.

NOTE: The Delay feature is only available on the line level output channels.

Output

Select **Output** to access the settings for **Minimum/Maximum Volume** and **Signal**.

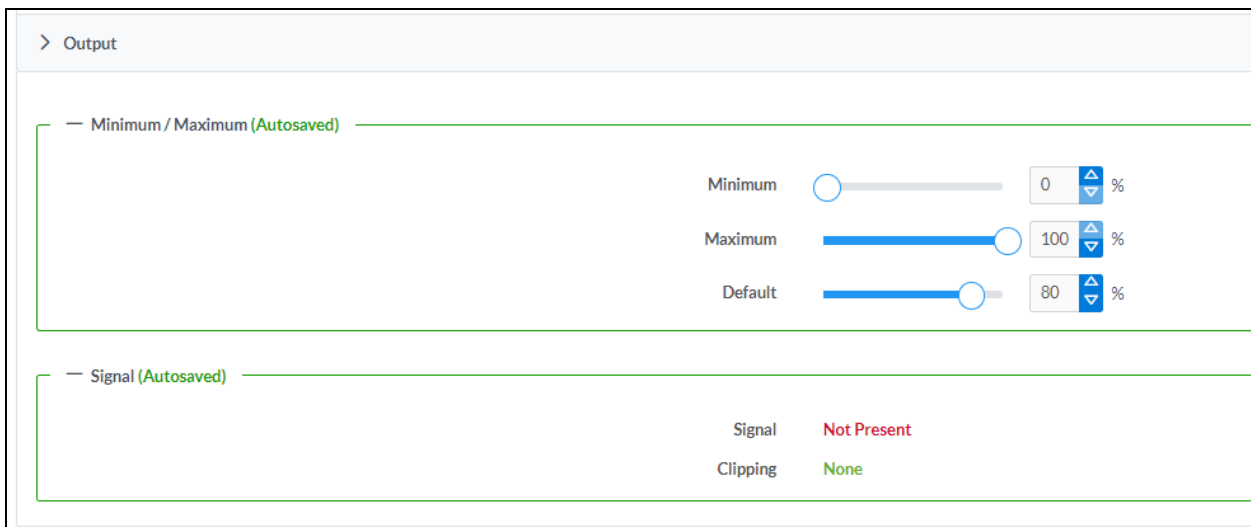

Minimum/Maximum Volume

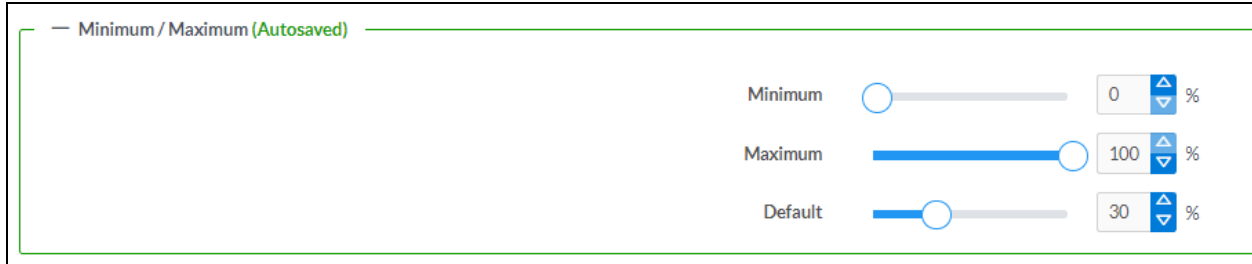

1. To set the minimum volume of the zone, do one of the following:
 - Move the **Minimum** slider to the right to increase or to the left to decrease the minimum volume.
 - Use the **%** arrows to increase or decrease the minimum volume. Values range from 0 to 50%, adjustable in increments of 1%.
 - Manually enter a value in the **Minimum** field.
2. To set the maximum volume of the zone, do one of the following:
 - Move the **Maximum** slider to the right to increase or to the left to decrease the maximum volume.
 - Use the **%** arrows to increase or decrease the maximum volume. Values range from 70 to 100%, adjustable in increments of 1%.
 - Manually enter a value in the **Maximum** field.

NOTE: When a **Minimum** and **Maximum** volume are set, the 1-100% range represented by the **Zone** and **Default** volume controls are scaled to the range set. For example, if a **Minimum** of 10% and a **Maximum** of 80% are set for a zone, the 1-100% range of the **Zone** volume control is scaled to the 10%-80% range set as the **Minimum** and **Maximum**.

3. To set the default volume of the zone, do one of the following:
 - Move the **Default** slider to the right to increase or to the left to decrease the default volume.
 - Use the **%** arrows to increase or decrease the default volume. Values range from 0 to 50%, adjustable in increments of 1%.
 - Manually enter a value in the **Default** field.

NOTE: The **Default** volume is applied as the **Zone** volume any time the zone receives a source route and no source was previously routed to that zone.

Signal

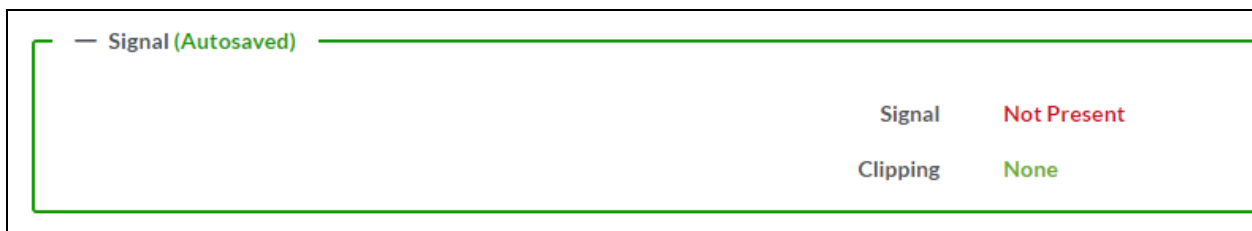

The **Signal** section is a read-only field that displays the **Signal** and **Clipping** status of the zone output.

- If an output signal is present but not clipping, **Signal** will display **Present** in green and **Clipping** will display **None** in green.
- If an output signal is present and clipping, **Signal** will display **Present** in green and **Clipping** will display **Present** in red.
- If no output signal is detected, **Signal** will display **Not Present** in red and **Clipping** will display **None** in green.

Input Channels

The **Input Channels** section is used to configure the **Name**, **Compensation**, and **Mute** attributes of the audio inputs of the DM-NAX-BTIO-1G.

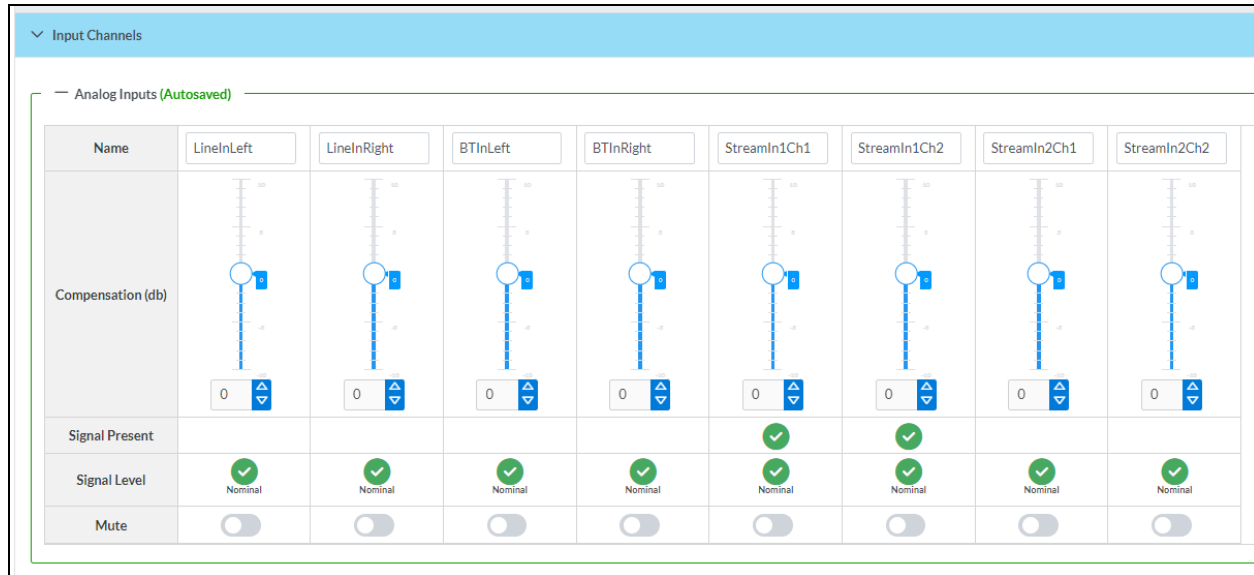

Name	LineInLeft	LineInRight	BTInLeft	BTInRight	StreamIn1Ch1	StreamIn1Ch2	StreamIn2Ch1	StreamIn2Ch2
Compensation (db)								
Signal Present					✓	✓	✓	
Signal Level	✓ Nominal	✓ Nominal	✓ Nominal	✓ Nominal	✓ Nominal	✓ Nominal	✓ Nominal	✓ Nominal
Mute	<input type="checkbox"/>	<input type="checkbox"/>	<input type="checkbox"/>	<input type="checkbox"/>	<input type="checkbox"/>	<input type="checkbox"/>	<input type="checkbox"/>	<input type="checkbox"/>

Configure Inputs

1. If needed, enter a friendly name for each input in its **Name** field.
2. To set a level compensation adjustment for a given input, do one of the following:
 - Move the **Compensation** slider up to increase or down to decrease the level compensation. Compensation increases or decreases the level of the incoming audio signal on any of the physical inputs on the device's rear panel.
 - Use the **db** arrows to increase or decrease the compensation. Values range from -10 dB to 10 dB, adjustable in increments of 1 dB.
 - Manually enter a value in the **Compensation** field.
3. To mute the signal from the corresponding input, set the **Mute** toggle to the right. To disable the mute, set the **Mute** toggle to the left. By default, **Mute** is disabled.

Monitor the device's input signals using the text indicators in the **Signal Present** and **Clipping Detected** columns:

- **Signal Presence** indicates whether or not a signal is detected in that zone.
- **Clipping Detected** indicates if the signal is **Clipping** or **Nominal** (non-clipping).

DM NAX Streams

The local inputs of the DM-NAX-BTIO-1G can be made available as DM NAX audio-over-IP streams. Two network stream transmitters are available on the device. One transmitter will encode the local unbalanced line level input, and the other will encode the Bluetooth input audio.

Select **NAX Streams** to expand the tab and display the following information.

This Device is the Leader PTP Clock Source **No**
 PTP Clock Leader MAC Address 00:1d:c1:12:16:68
 PTP Priority 254

— Transmitters (Autosaved)

Audio Source	Stream	Nax Stream Address	Nax Stream Name	Status	Actions
StreamOut1Ch1	Stream01	239.69.18.1	Stream01-AUD-USB	Stream Started	▶ ⏏ ⚙
StreamOut2Ch1	Stream02	239.69.18.2	Stream02-AUD-USB	Stream Started	▶ ⏏ ⚙

— Receivers (Autosaved)

Zone Name	Stream	Current Stream Address	Requested Stream Address	Status	Actions
StreamIn1Ch1	Stream01	239.69.2.1	239.69.2.1	Stream Started	▶ ⏏ ⚙
StreamIn2Ch1	Stream02	239.69.61.139	239.69.61.139	Stream Started	▶ ⏏ ⚙

- **Device is Leader PTP Clock Source** indicates whether the DM NAX device's PTP clock is the leader clock on the network. **Yes** will be displayed in green when the local DM-NAX-BTIO-1G's clock is the PTP leader clock and **No** will be displayed in red when another PTP clock on the network is operating as the leader clock.
- **Leader Clock Status** displays the Leader Clock ID of the device on the network that is currently acting as the leader clock.
- **PTP Priority:** This sets the priority of the local DM NAX device's PTP clock relative to other clocks on the network. The default setting is 254 (one increment higher than the lowest possible value) so that the DM-NAX-BTIO-1G will only operate as the leader clock if no other PTP leader is present on the network. Valid values range from 1 to 255.

Configure Transmitters

To configure the DM NAX transmit stream:

1. Enter a valid multicast address in the **NAX Stream Address** field.
2. Enter a name in the **NAX Stream Name** field by which the stream can be identified. This stream name is associated with the DM NAX stream's multicast address by other DM NAX or AES67 devices, like a device hostname that resolves to a given IP address.
3. **Status** indicates whether a stream is transmitting or not. When the stream has started or stopped, the **Status** column will update accordingly.
4. Select the configure icon  in the **Actions** column. The **Configure** dialog appears:

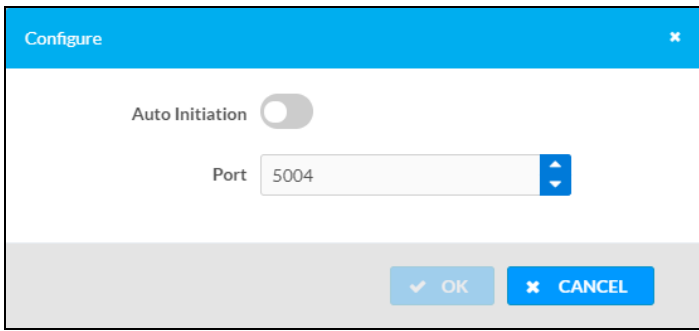

5. Set the **Auto Initiation** toggle to the right position to enable auto initiation. Set the toggle to the left position to disable auto initiation.
 - If **Auto Initiation** is enabled for a given stream, the stream will begin transmitting automatically and will be available as a multicast stream on your network at the specified multicast address.
 - If **Auto Initiation** is disabled for the input, the stream will not begin transmitting until it is manually initiated.
6. To set the port number, do one of the following:
 - Use the arrows to increase or decrease the port number by increments of 1.
 - Manually enter a port number in the **Port** field. The default port number for DM NAX streams is 5004.
7. Select **OK** to save or select **Cancel** to cancel the changes.

Configure Receivers

1. Enter the multicast address of a transmitting stream in the **Requested Stream Address** field to subscribe the receiver to the stream.
2. Select the configure icon  in the **Actions** column. The **Configure** dialog appears:

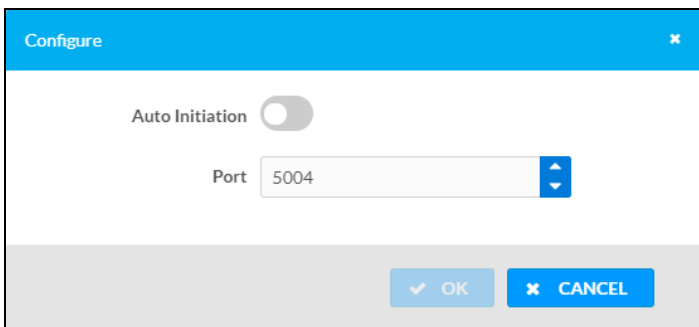

3. Set the **Auto Initiation** toggle to the right position to enable auto initiation. Set the toggle to the left position to disable auto initiation.
 - If **Auto Initiation** is enabled, the stream will begin automatically when the receiver subscribes to the transmitter.
 - If **Auto Initiation** is disabled, the stream will not begin until it is manually initiated.

4. To set the port number, do one of the following:
 - Use the arrows to increase or decrease the port number by increments of 1.
 - Manually enter a port number in the **Port** field. The default port number is 5004.
5. Select **OK** to save or select **Cancel** to cancel the changes.

Mixing

The **Mixing** matrix is used to route a local input or AES67 stream to an output on the DM-NAX-BTIO-1G.

NOTE: To receive an AES67 stream from Dante devices, see [OLH 1001151](#).

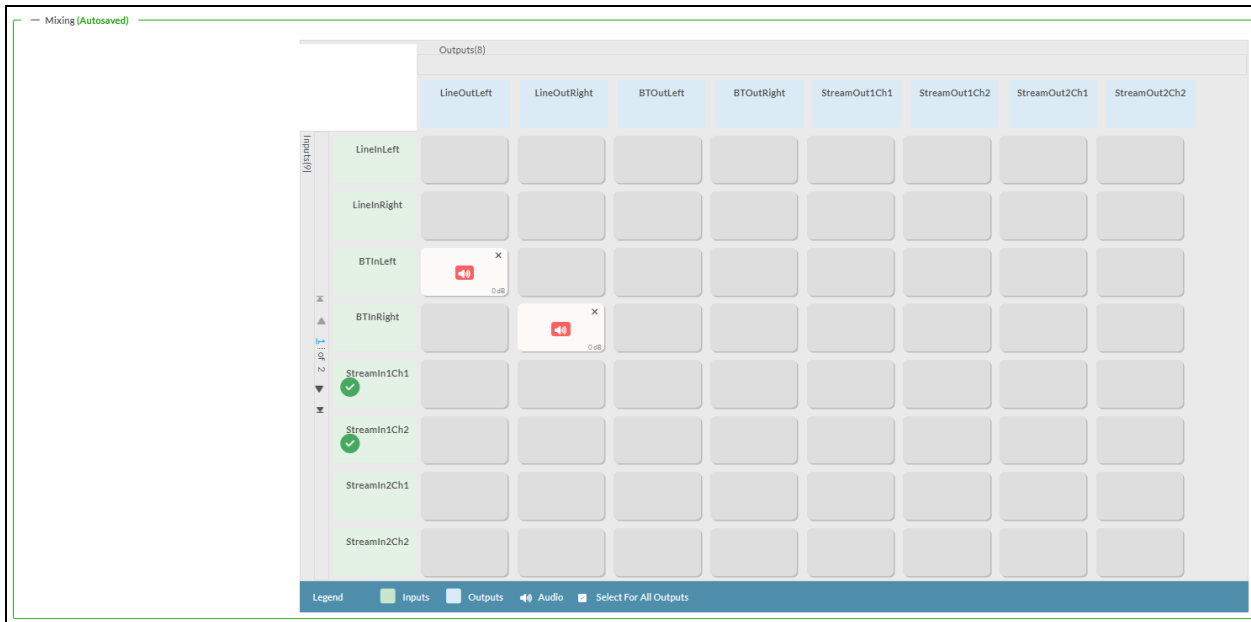

To route inputs to outputs on the device:

- Select the cells corresponding to the desired output that are to be paired for routing. Once a route is made, appears. The input that you have selected for a given row will route to the output corresponding to that row in the matrix.
- Use the arrows (or) at the left of the matrix to change pages to view all available inputs.
- To break a given route select or .

Each output can have any number of inputs routed to it. To adjust the mix setting for a route, select the **dB** value of the cell, then do one of the following:

- Move the slider up to increase or down to decrease the mix level.
- Use the arrows to increase or decrease the mix level.
- Manually enter a value in the field.

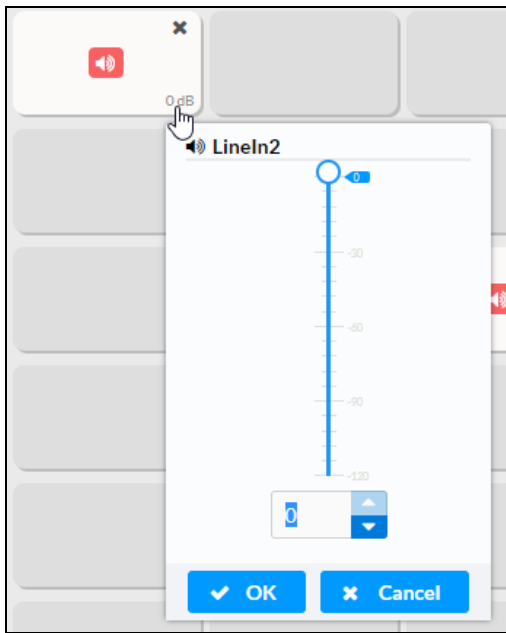

Residential Mode

This section provides the following information:

- [System Setup on page 605](#)
- [Commissioning on page 610](#)
- [Bluetooth on page 611](#)
- [Display on page 613](#)
- [Output Channels on page 613](#)
- [Inputs on page 618](#)
- [NAX Streams on page 619](#)
- [Routing on page 621](#)

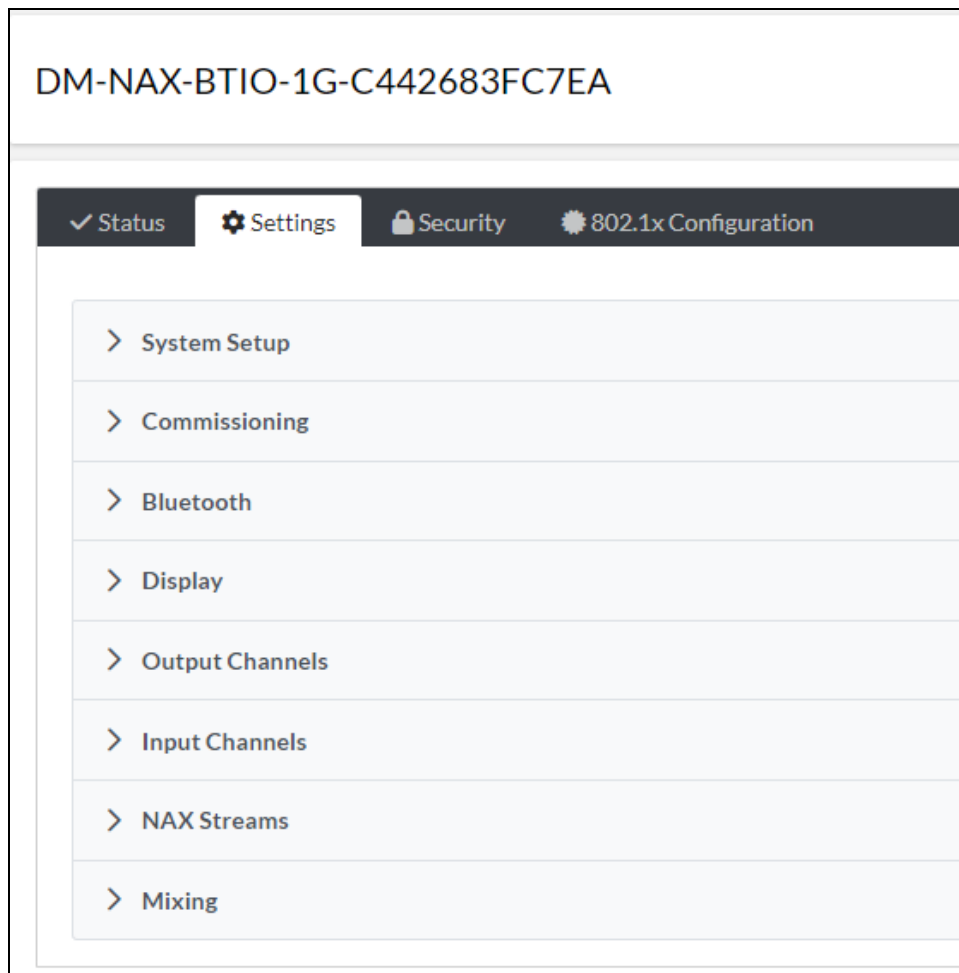

System Setup

The **System Setup** section displays information about the Date/Time, Auto Update, Network, Control System, Cloud Settings, and Device Modes.

Date/Time

Use the **Date/Time** section to configure the date and time settings of the DM-NAX-BTIO-1G.

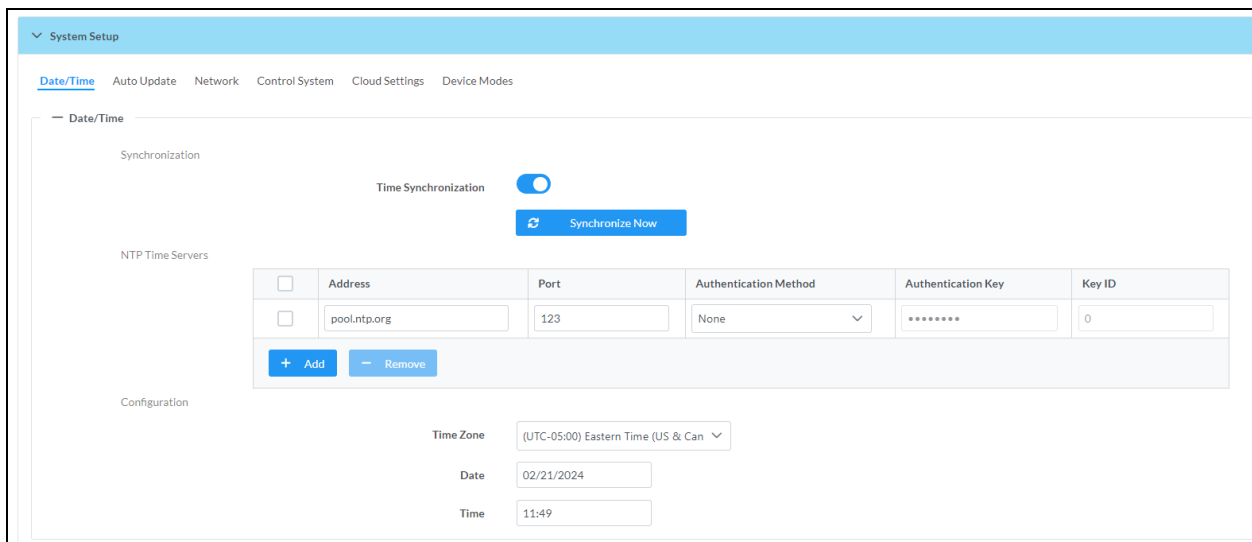

Time Synchronization

1. Set the **Time Synchronization** toggle to the right position to enable or left position to disable time synchronization. By default, time synchronization is enabled.
2. In the **NTP Time Servers** table, enter the URL of a NTP (Network Time Protocol) or SNTP (Simple Network Time Protocol) server. Up to three time servers can be added on a device.
3. Select **Synchronize Now** to perform time synchronization between the device's internal clock and the time server.

Time Configuration

1. Open the **Time Zone** drop-down menu to select the applicable time zone.
2. In the **Date** field, enter the current date.
3. In the **Time (24hr Format)** field, enter the current time in 24-hour format.

Select **Save Changes** to save the settings.

Select **Revert** from the **Action** drop-down menu to revert to the previous settings without saving.

Auto Update

The DM-NAX-BTIO-1G can automatically check for and install firmware updates at scheduled intervals via the Auto Update feature.

The screenshot shows the 'Auto Update' configuration page in the System Setup menu. The 'Auto Update' toggle is turned on. The 'Custom URL' toggle is turned off. The 'Custom URL Path' is set to 'https://crestrondevicefiles.blob.core.win...'. The 'Day of Week' is set to 'Daily'. The 'Time of Day' is set to '02:25'. The 'Poll Interval' is set to '0' minutes. An 'Update Now' button is located at the bottom right of the configuration area.

1. Set the **Auto Update** toggle to the right position to enable Auto Update.
2. Define the URL to download the updates by doing either of the following:
 - a. Use the default URL to download the updates from the Crestron server.
 - b. Use a custom URL. Set the **Custom URL** toggle to the right position to enable a custom URL. In the **Custom URL Path** text box, enter the path to a custom manifest file in the FTP or SFTP URL format. Use the Crestron Auto Update Tool to generate a custom manifest file, then store the file on an FTP (File Transfer Protocol) or SFTP (Secure File Transfer Protocol) server.
3. Set a schedule for the automatic firmware update by doing either of the following:
 - a. Select the desired **Day of Week** and **Time of Day** (24-hour format) values.
 - b. Set the **Poll Interval** by entering a value from **60** to **65535** minutes. A value of **0** disables the Poll Interval.
4. Select **Save Changes**.

Selecting **Update Now** causes the device to check for a firmware update immediately. If a schedule was set in step 4 above, that schedule still remains in effect.

Network

The **Network** section contains network-related settings for the DM-NAX-BTIO-1G, including the Hostname, Domain, Primary Static DNS, and Secondary Static DNS.

Date/Time Auto Update **Network** Control System Cloud Settings Device Modes

— Network

Adapter 1

Hostname *	DM-NAX-BTIO-1G-C442683FC7EA
Domain	CRESTRON.CRESTRON.com
Primary Static DNS	10.64.5.10(DHCP)
Secondary Static DNS	192.168.200.133(DHCP)
DHCP Enabled	<input checked="" type="checkbox"/>
IP Address	10.64.68.175
Subnet Mask	255.255.255.0
Default Gateway	10.64.68.1

NOTE: By default, the host name of the DM-NAX-BTIO-1G consists of the model name followed by the MAC address of the device. For example, DM-NAX-BTIO-1G-00107FB58088.

Adapter 1

The Adapter 1 subheading contains settings for DHCP, IP Address, Subnet Mask, and Default Gateway of Ethernet adapter 1 on the rear panel of the device.

NOTE: DM NAX devices' internal processes use IP addresses in the 10.10.10.xxx range. This IP range should be avoided when addressing DM NAX devices to prevent conflicts.

Set the **DHCP** toggle to enabled (right) or disabled (left) to specify whether the IP address of the DM-NAX-BTIO-1G is to be assigned by a DHCP (Dynamic Host Configuration Protocol) server.

- **Enabled:** When DHCP is enabled (default setting), the IP address of the DM-NAX-BTIO-1G is automatically assigned by a DHCP server on the local area network (LAN).
- **Disabled:** When DHCP is disabled, manually enter information in the following fields:
 - **Primary Static DNS:** Enter a primary DNS IP address.
 - **Secondary Static DNS:** Enter a secondary DNS IP address.
 - **IP Address:** Enter a unique IP address for the DM-NAX-BTIO-1G.
 - **Subnet Mask:** Enter the subnet mask that is set on the network.
 - **Default Gateway:** Enter the IP address that is to be used as the network's gateway.

To save any new network entries, select **Save Changes**.

Control System

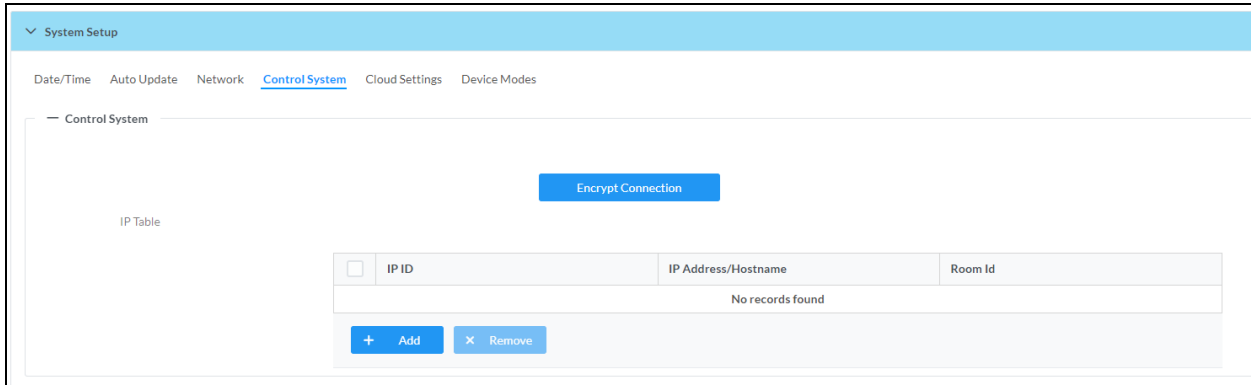

1. Select **Encrypt Connection** to navigate to the **Security** tab to configure encryption settings.
 - a. Enter the username in the **Control System Username** field.
 - b. Enter the password in the **Control System Password** field.
2. Select **+ Add** to add an IP table entry to the **IP Table**.
 - a. Enter the Room ID in the **Room ID** field.
 - b. Enter the IP ID of the DM-NAX-BTIO-1G in the **IP ID** field.
 - c. Enter the IP address or hostname of the control system in the **IP Address/Hostname** field.
3. Select **Save Changes** to save the new entries. The **Control System Save** message box appears, indicating that the control system settings were saved successfully. Select **Revert** to revert to the previous settings without saving.

Cloud Settings



Set the **Cloud Settings** toggle to enabled (right) or disabled (left) to specify whether the DM-NAX-BTIO-1G can communicate with the XiO Cloud® platform.

Device Modes

Use the **Device Modes** section to configure the **Application Mode**.

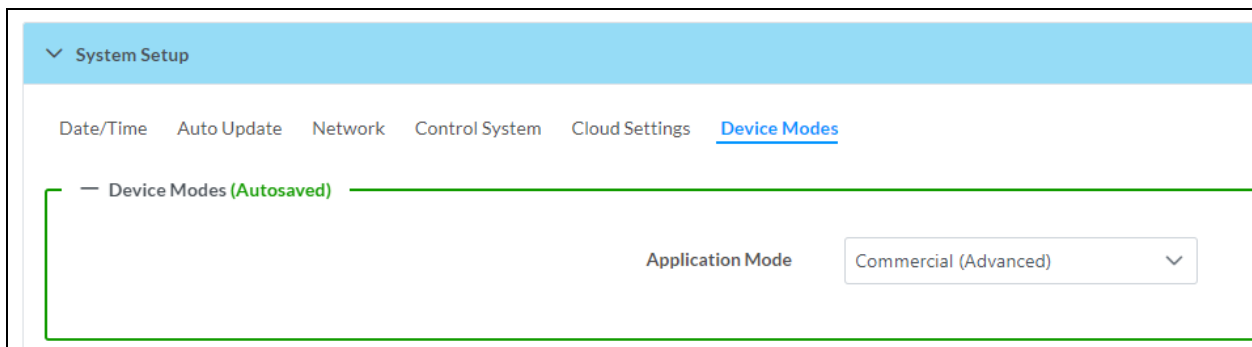

- **Application Mode:** The Application Mode determines which options and controls are available.
 - Select **Residential (Standard)** or **Commercial (Advanced)**. A **Reboot** confirmation message box appears.

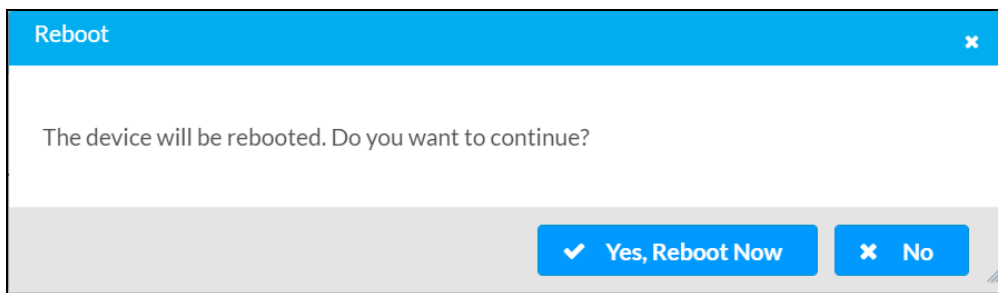

- Select **Yes, Reboot Now** to reboot the device into the selected mode. The **Reboot** message box appears.
- Wait for the device reboot to complete before attempting to reconnect to the device.

Commissioning

The **Commissioning** section provides a quick way to automatically assign multicast addresses to the device's internal audio-over-IP stream transmitters.

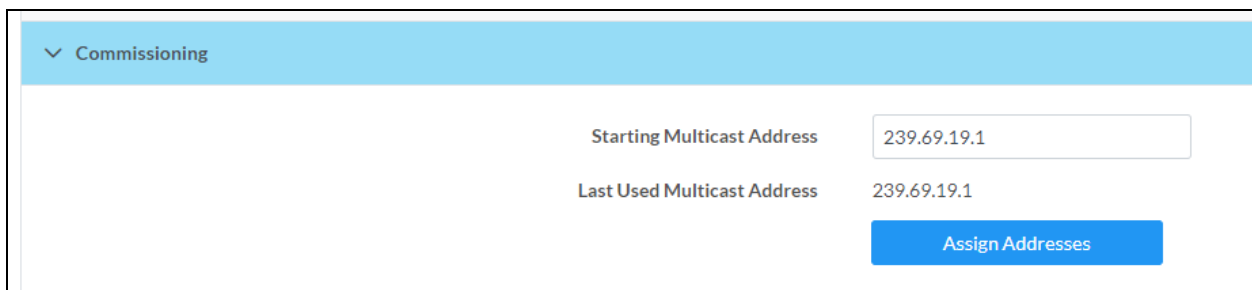

Select **Assign Addresses** to give each DM NAX transmitter in the DM-NAX-BTIO-1G a unique multicast address beginning with the specified **Starting Multicast Address**. The valid range for **Starting Multicast Address** is 239.8.0.0 to 239.127.255.254.

NOTE: This will begin transmitting multicast traffic on your network. Refer to [Audio-over-IP Network Design on page 632](#) for details on proper audio-over-IP network management.

Bluetooth

The **Bluetooth** section provides settings for the internal Bluetooth radio of the DM-NAX-BTIO-1G. These settings are divided up into two tabs, labeled **Main** and **Advanced**.

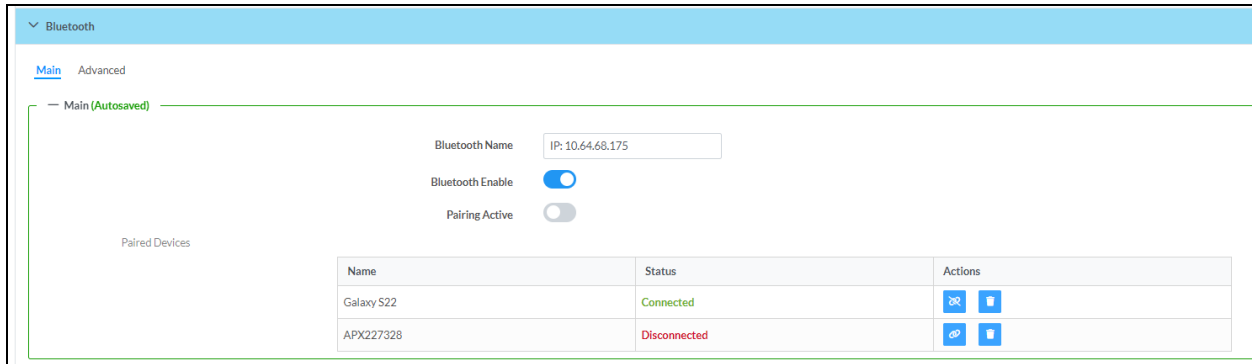

Main Bluetooth Settings



To configure the settings on the **Main** tab of the Bluetooth settings section:

- Enter a custom name for the DM-NAX-BTIO-1G in the **Bluetooth Name** text field. This is the name that will be displayed on source devices (such as smartphones) that discover the DM-NAX-BTIO-1G as a casting destination.
- Set the **Bluetooth Enable** toggle to the right to allow Bluetooth wireless audio casting to the DM-NAX-BTIO-1G. Set the **Bluetooth Enable** toggle to the left to disable Bluetooth wireless audio.

NOTE: While Bluetooth audio is disabled on the device, some applications that scan for Bluetooth devices may still be able to detect the DM-NAX-BTIO-1G. These devices will not be able to connect to the DM-NAX-BTIO-1G or cast audio to it while Bluetooth audio is disabled.

- Set the **Pairing Active** toggle to the right to enable pairing mode, allowing Bluetooth devices to pair to the DM-NAX-BTIO-1G. Set the **Pairing Active** toggle to the left to disable pairing mode.
- The **Paired Devices** table displays the name and status of all remembered Bluetooth devices that have previously paired with the DM-NAX-BTIO-1G.
 - The DM-NAX-BTIO-1G can remember up to seven previously paired devices.
 - Only one paired Bluetooth device can have a **Connected** at a time. All other paired devices will display a **Disconnected** status.
 - To disconnect a connected device, select the disconnect icon .
 - To forget a remembered device from the **Paired Devices** table, select the trashcan icon .

Advanced Bluetooth Settings

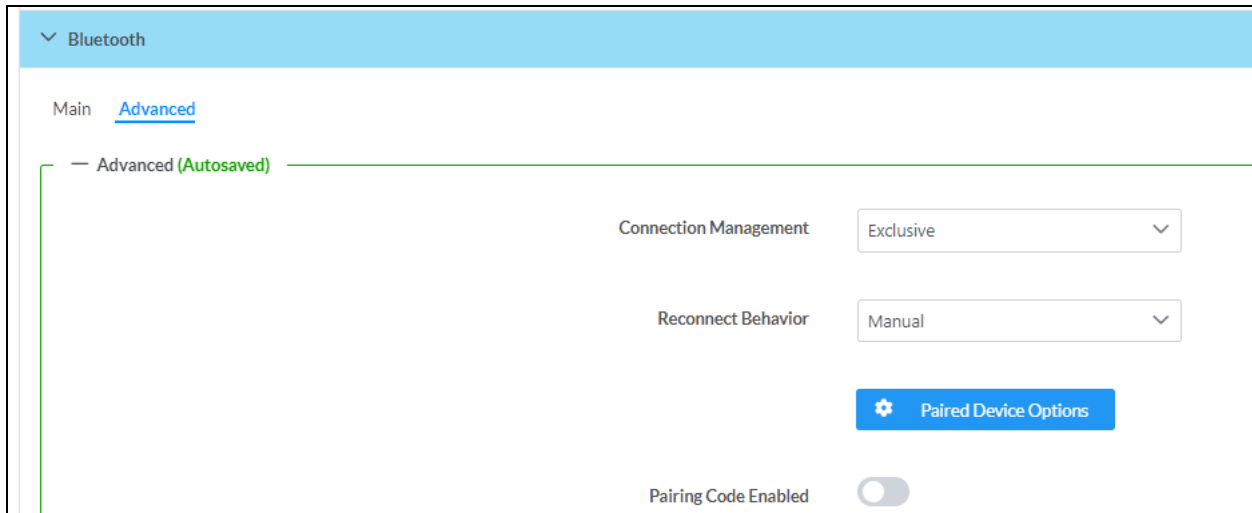

To configure the settings on the **Advanced** tab of the Bluetooth settings section:

- Select a **Connection Management** option from the drop-down. **Exclusive** mode is selected by default.
 - In **Interrupt** mode, remembered paired devices can reconnect to the DM-NAX-BTIO-1G from their Bluetooth connections list, and will interrupt any currently playing audio. The most recent casting device to select the DM-NAX-BTIO-1G from its Bluetooth list will show a **Connected** status in the **Paired Devices** table, and all other devices will revert to **Disconnected**.
 - In **Exclusive** mode, remembered paired devices cannot be reconnected to the DM-NAX-BTIO-1G from their Bluetooth connections list until the currently **Connected** device is disconnected. The device that is listed as **Connected** in the **Paired Devices** table will remain as the **Connected** device until it is disconnected by programming, from the web interface, or by the casting device itself.
 - **Temporary** mode is the same as **Exclusive** mode, with the added behavior that the DM-NAX-BTIO-1G will forget the currently connected device once it is disconnected.
- Select a **Reconnect Behavior** option from the drop-down. **Manual** is selected by default.
 - **Manual** reconnection means that any time the Bluetooth casting device is disconnected from the DM-NAX-BTIO-1G, it can only be reconnected by selecting the casting device from the DM NAX device's list of paired devices. This is the recommended setting for any system with multiple paired transmitting devices or multiple DM-NAX-BTIO-1G devices within range of each other.
 - **Automatic** reconnection means that any remembered paired Bluetooth casting device will reconnect to the DM-NAX-BTIO-1G when it is within the wireless range of the DM NAX device.

- Select **Paired Device Options** to open a **Paired Device Options** window. Select a command from the drop-down menu, then select **Send** to issue the command to the DM NAX device.
 - **Release All Paired Devices:** Disconnects all currently paired devices from the DM-NAX-BTIO-1G.
 - **Release Inactive Paired Devices:** Disconnects any paired device that is not actively playing any media.
 - **Forget All Paired Devices:** Deletes all currently paired devices from the **Paired Devices** table of the DM-NAX-BTIO-1G.
 - **Forget Inactive Paired Devices:** Disconnects and forgets any paired device that is not actively playing any media.
 - **Forget Connected Devices:** Disconnects and forgets only the current **Connected** device.
- Set the **Pairing Code Enabled** toggle to the right to enable the pairing code feature. When this is enabled, a pairing code string will populate on both the casting device and the OLED display of the DM-NAX-BTIO-1G during pairing. Confirm that the code matches on each device to complete the pairing process. Set the toggle to the left to disable the pairing code feature. The pairing code feature is disabled by default.

Display

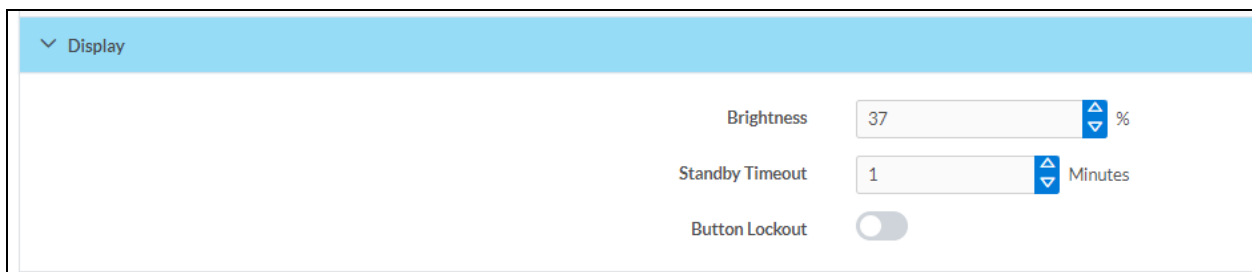

The **Display** section contains settings that affect the front panel OLED display of the DM-NAX-BTIO-1G.

- To adjust the display brightness:
 - Use the **%** arrows to increase or decrease the brightness. Values range from 0 to 100%, adjustable in increments of 1%.
 - Manually enter a percentage value in the **Brightness** text field.
- To adjust the display standby timeout:
 - Use the **Minutes** arrows to increase or decrease the brightness. The default timeout value is one minute.
 - Manually enter a value in the **Standby Timeout** text field.
- Set the **Button Lockout** toggle to the right to lock out the front panel buttons on the DM-NAX-BTIO-1G. Set the **Button Lockout** toggle to the left to disable the lockout.

Output Channels

The **Zones** section contains the **Volume** and **Mute** settings for all zone outputs of the device, as well as a Configure option for more advanced settings within each zone.

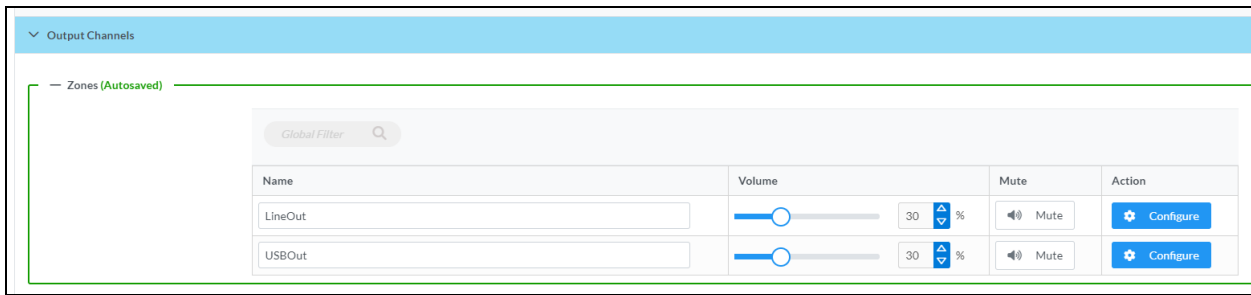

Give each zone a friendly name using the **Name** column of the **Zones** table. If the device is paired with a control system, these names may be overwritten by the control system's program.

To configure the zone volume, do one of the following:

- Move the **Volume** slider to the right to increase or to the left to decrease the zone volume.
- Use the **%** arrows to increase or decrease the zone volume. Values range from 0 to 100%, adjustable in increments of 1%.
- Manually enter a value in the **Volume** field.

To mute all audio output from a zone, select its respective **Mute**. To unmute the zone, select **Muted**.

Zone Settings

To configure zone settings, select **Configure** (**Configure**). The **Edit Zone** window appears.

Zone

Select **Zone** to access the settings for **Balance** and **Delay**.

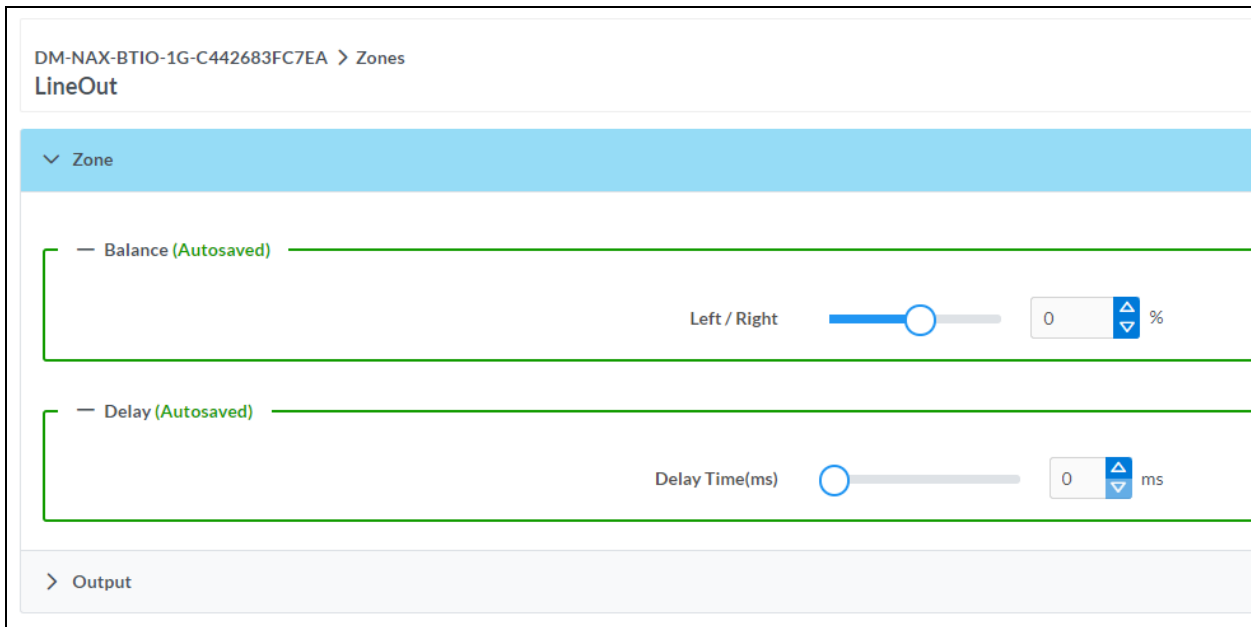

Balance

To adjust the left/right balance of the stereo output signal, do one of the following:

- Move the **Balance** slider to the right to shift the stereo balance to the right channel or to the left to shift the balance to the left.
- Use the arrows to adjust the balance left or right. The up arrow shifts the balance to the right while the down arrow shifts the balance to the left.
- Manually enter a value in the **Balance** field. Values range from -50 to 50, adjustable in increments of 1. Positive values shift the balance to the right while negative values shift the balance to the left.

Delay

To set the delay, do one of the following:

- Move the **Delay Time(ms)** slider to the right to increase or to the left to decrease the delay time.
- Use the **ms** arrows to increase or decrease the delay. Values range from 0 ms to 85 ms, adjustable in increments of 1 ms.
- Manually enter a value in the **Delay Time(ms)** field.

NOTE: The Delay feature is only available on the line level output channels.

Output

Select **Output** to access the settings for **Minimum/Maximum Volume**, **Stereo/Mono**, and **Signal**.

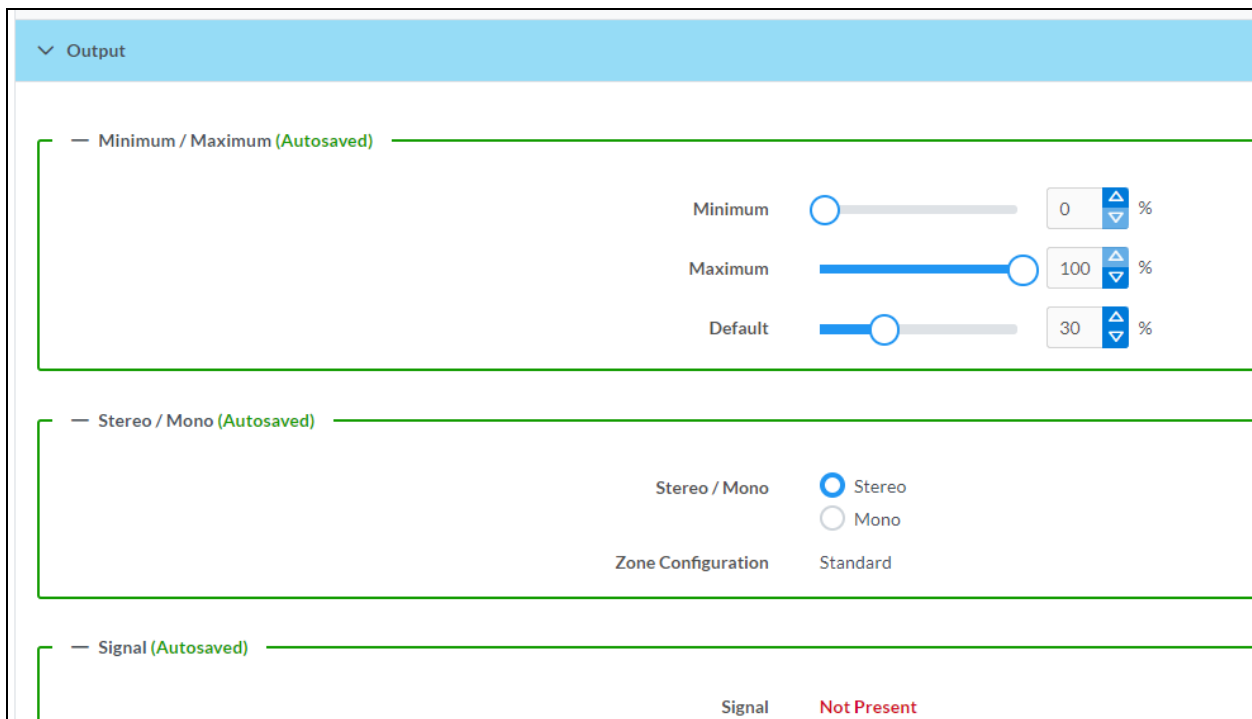

Minimum/Maximum Volume

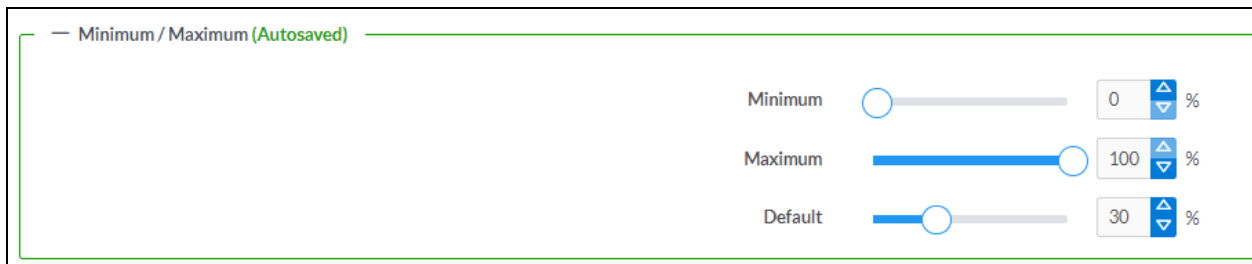

1. To set the minimum volume of the zone, do one of the following:

- Move the **Minimum** slider to the right to increase or to the left to decrease the minimum volume.
- Use the **%** arrows to increase or decrease the minimum volume. Values range from 0 to 50%, adjustable in increments of 1%.
- Manually enter a value in the **Minimum** field.

- To set the maximum volume of the zone, do one of the following:
 - Move the **Maximum** slider to the right to increase or to the left to decrease the maximum volume.
 - Use the **%** arrows to increase or decrease the maximum volume. Values range from 70 to 100%, adjustable in increments of 1%.
 - Manually enter a value in the **Maximum** field.

NOTE: When a **Minimum** and **Maximum** volume are set, the 1-100% range represented by the **Zone** and **Default** volume controls are scaled to the range set. For example, if a **Minimum** of 10% and a **Maximum** of 80% are set for a zone, the 1-100% range of the **Zone** volume control is scaled to the 10%-80% range set as the **Minimum** and **Maximum**.

- To set the default volume of the zone, do one of the following:
 - Move the **Default** slider to the right to increase or to the left to decrease the default volume.
 - Use the **%** arrows to increase or decrease the default volume. Values range from 0 to 50%, adjustable in increments of 1%.
 - Manually enter a value in the **Default** field.

NOTE: The **Default** volume is applied as the **Zone** volume any time the zone receives a source route and no source was previously routed to that zone.

Stereo/Mono

— Stereo / Mono (Autosaved)

Stereo / Mono Stereo
 Mono

Zone Configuration Standard

Select either **Stereo** or **Mono**. If **Stereo** is selected, both output channels can have independent audio content. If **Mono** is selected, both output channels receive the same audio content.

Signal

— Signal (Autosaved)

Signal Not Present
Clipping None

The **Signal** section is a read-only field that displays the **Signal** and **Clipping** status of the zone output.

- If an output signal is present but not clipping, **Signal** will display **Present** in green and **Clipping** will display **None** in green.
- If an output signal is present and clipping, **Signal** will display **Present** in green and **Clipping** will display **Present** in red.
- If no output signal is detected, **Signal** will display **Not Present** in red and **Clipping** will display **None** in green.

Select **Done** to return to the **Settings** tab of the web user interface.

Inputs

The **Inputs** section is used to configure the **Name**, **Compensation**, and **Mute** attributes of the available analog, digital, and media streaming inputs on the DM-NAX-BTIO-1G.

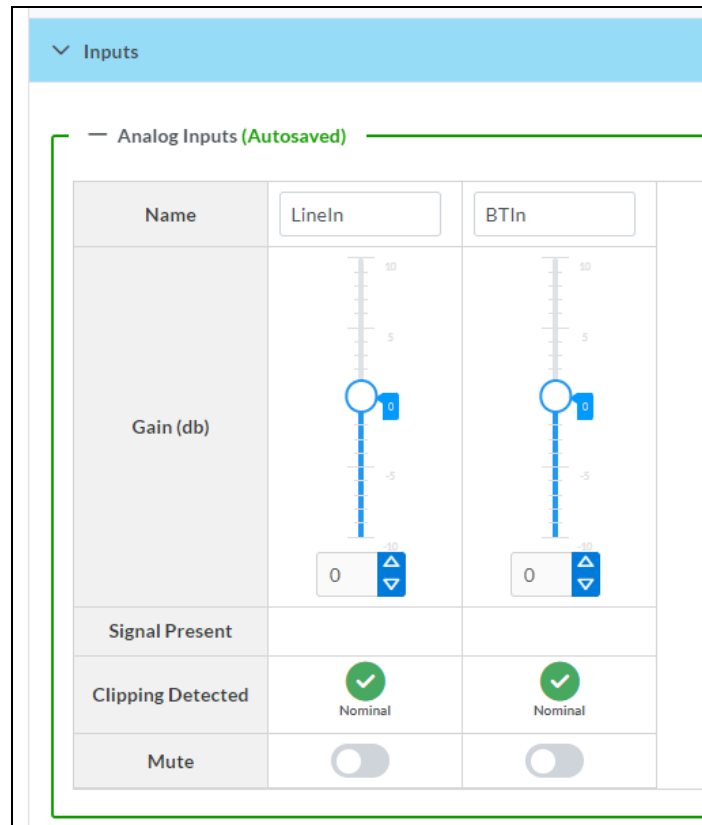

Configure Inputs

1. If needed, enter a friendly name for each input in its **Name** field.
2. To set a level compensation adjustment for a given input, do one of the following:
 - Move the **Compensation** slider up to increase or down to decrease the level compensation. Compensation increases or decreases the level of the incoming audio signal on any of the physical inputs on the device's rear panel.
 - Use the **db** arrows to increase or decrease the compensation. Values range from -10 dB to 10 dB, adjustable in increments of 1 dB.
 - Manually enter a value in the **Compensation** field.

- To mute the signal from the corresponding input, set the **Mute** toggle to the right. To disable the mute, set the **Mute** toggle to the left. By default, **Mute** is disabled.

Monitor the device's input signals using the text indicators in the **Signal Present** and **Clipping Detected** columns:

- **Signal Presence** indicates whether or not a signal is detected in that zone.
- **Clipping Detected** indicates if the signal is **Clipping** or **Nominal** (non-clipping).

NAX Streams

The two local inputs of the DM-NAX-BTIO-1G can be made available as DM NAX audio-over-IP streams.

Select **NAX Streams** to expand the tab and display the following information.

The screenshot displays the NAX Streams configuration interface. At the top, it indicates the device's PTP status: "This Device is the Leader PTP Clock Source" is set to "No" in red. Below this, the "PTP Clock Leader MAC Address" is shown as "00.1d.c1.12.16.68" and the "PTP Priority" is set to "254".

There are two main sections: "Transmitters (Autosaved)" and "Receivers (Autosaved)".

Transmitters (Autosaved):

Audio Source	Stream	Nax Stream Address	Nax Stream Name	Status	Actions
LineIn	Stream01	239.69.17.1	Stream01-BTIO	Stream Started	▶ □ ⚙
BTIn	Stream02	239.69.17.2	Stream02-BTIO	Stream Started	▶ □ ⚙

Receivers (Autosaved):

Zone Name	Stream	Current Stream Address	Requested Stream Address	Status	Actions
LineOut	Stream01	239.69.190.168	239.69.190.168	Stream Started	▶ □ ⚙
BTOut	Stream02	239.69.2.1	239.69.2.1	Stream Started	▶ □ ⚙

- **Device is Leader PTP Clock Source** indicates whether the device is the leader for PTP on the network. **Yes** will be displayed in green when the local DM-NAX-BTIO-1G is the PTP leader clock and **No** will be displayed in red when another PTP clock on the network is operating as the leader clock.
- **Leader Clock Status** displays the Leader Clock ID of the device on the network that acts as the Leader Clock.
- **PTP Priority:** This sets the priority of the local DM NAX device's PTP clock relative to other clocks on the network. The default setting is 254 (one increment higher than the lowest possible value) so that the DM-NAX-BTIO-1G will only operate as the leader clock if no other PTP leader is present on the network. Valid values range from 1 to 255.

Configure Transmitters

To configure a DM NAX transmit stream:

1. Enter a valid multicast address in the **NAX Stream Address** field.
2. Enter a name in the **NAX Stream Name** field by which the stream can be identified. This stream name is associated with the DM NAX stream's multicast address by other DM NAX or AES67 devices, like a device hostname that resolves to a given IP address.
3. **Status** indicates whether a stream is transmitting or not. When the stream has started or stopped, the **Status** column will update accordingly.
4. Select the configure icon  in the **Actions** column. The **Configure** dialog appears:



5. Set the **Auto Initiation** toggle to the right position to enable auto initiation. Set the toggle to the left position to disable auto initiation.
 - If **Auto Initiation** is enabled for a given stream, the stream will begin transmitting automatically and will be available as a multicast stream on your network at the specified multicast address.
 - If **Auto Initiation** is disabled for the input, the stream will not begin transmitting until it is manually initiated.
6. To set the port number, do one of the following:
 - Use the arrows to increase or decrease the port number by increments of 1.
 - Manually enter a port number in the **Port** field. The default port number for DM NAX streams is 5004.
7. Select **OK** to save or select **Cancel** to cancel the changes.

Configure Receivers

1. Enter the multicast address of a transmitting stream in the **Requested Stream Address** field to subscribe the receiver to the stream.
2. Select the configure icon  in the **Actions** column. The **Configure** dialog appears:

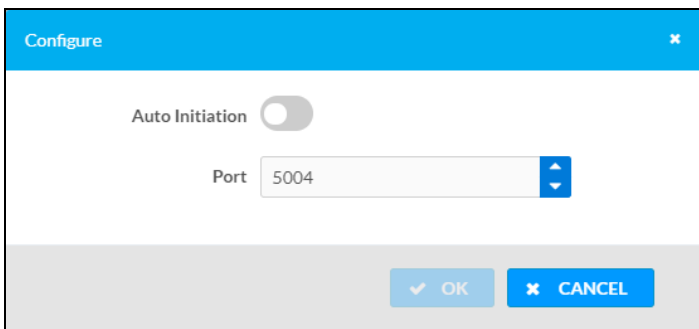

3. Set the **Auto Initiation** toggle to the right position to enable auto initiation. Set the toggle to the left position to disable auto initiation.
 - If **Auto Initiation** is enabled, the stream will begin automatically when the receiver subscribes to the transmitter.
 - If **Auto Initiation** is disabled, the stream will not begin until it is manually initiated.

4. To set the port number, do one of the following:
 - Use the arrows to increase or decrease the port number by increments of 1.
 - Manually enter a port number in the **Port** field. The default port number is 5004.
5. Select **OK** to save or select **Cancel** to cancel the changes.

Routing

The **Routing** section is used to route a local input or AES67 stream to a Zone on the DM-NAX-BTIO-1G.

NOTE: To receive an AES67 stream from Dante devices, see [OLH 1001151](#).

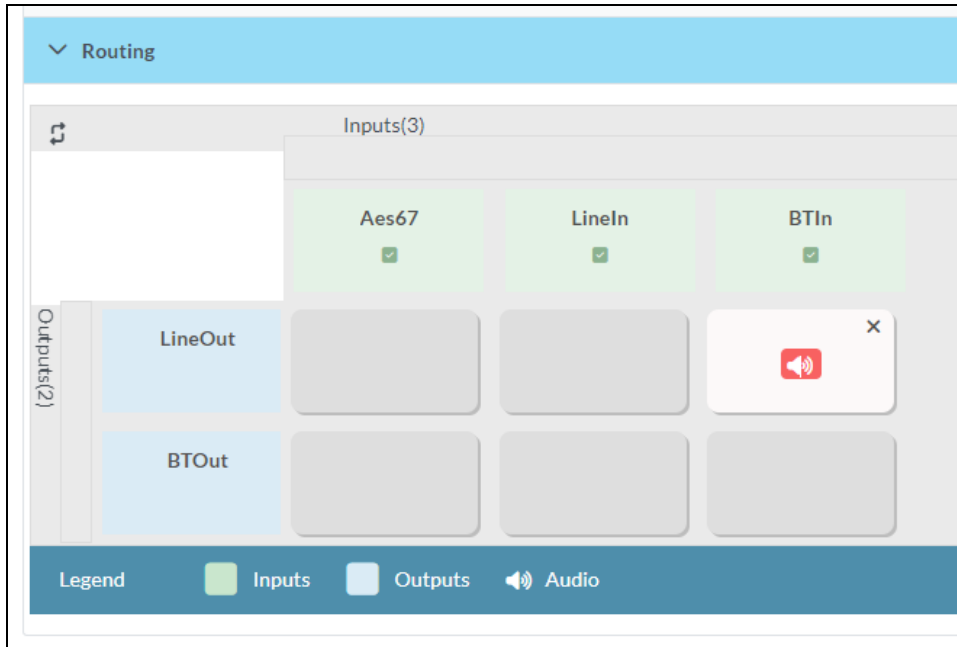

- To route an input to a zone, select the box in the routing matrix where the zone's row overlaps the corresponding input's column. Once a route is made, appears.
- To break a given route select or .
- To route a single input to all zones, select the icon under the input's name.

Security

Select the **Security** tab to configure security for users and groups and to allow different levels of access to the DM-NAX-BTIO-1G functions. By default, security is disabled.

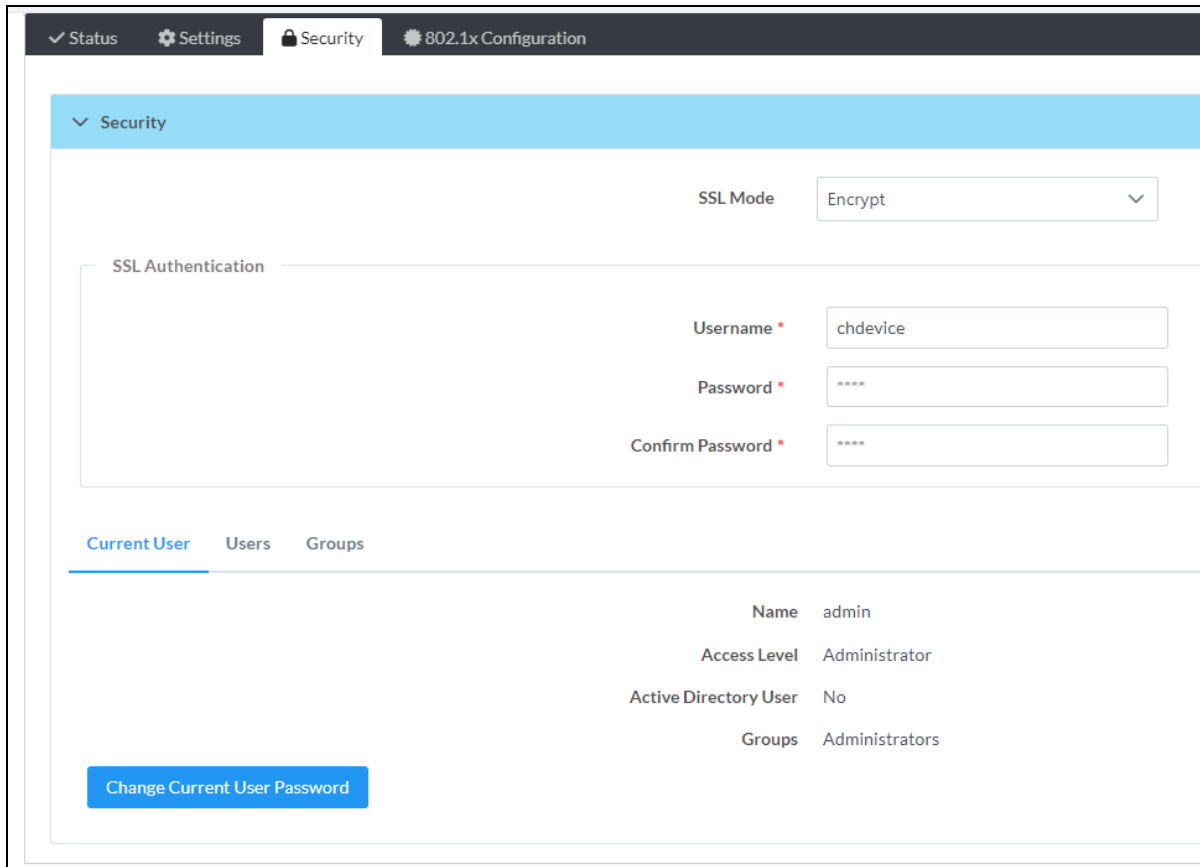

Select **Encrypt and Validate**, **Encrypt**, or **OFF** in the **SSL Mode** drop-down menu, to specify whether to use encryption. By default, SSL Mode is set to **OFF**.

Current User

Select the **Current User** tab to view read-only information or to change the password for the current user.

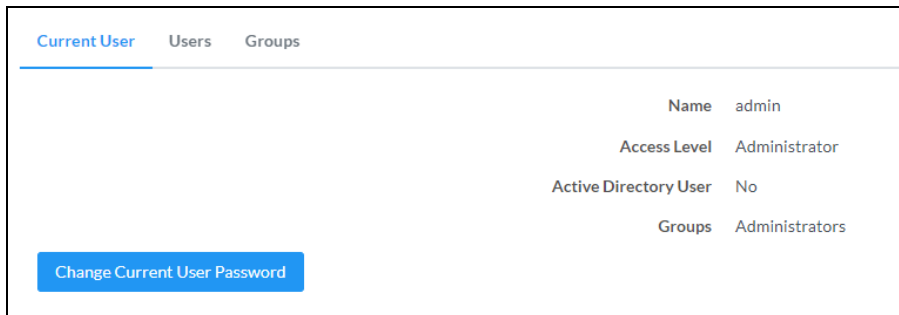

1. Select **Change Current User Password** to provide a new password for the current user.
2. In the **Change Password** dialog, enter the current password in the **Current Password** field, the new password in the **Password** field, and then re-enter the same new password in the **Confirm Password** field.

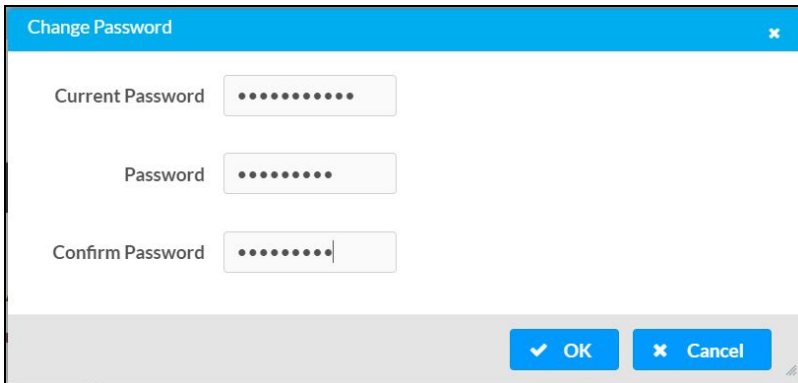

The image shows a 'Change Password' dialog box with a blue header and a close button. It contains three password input fields: 'Current Password', 'Password', and 'Confirm Password'. Each field is filled with dots. At the bottom, there are two buttons: 'OK' with a checkmark icon and 'Cancel' with an 'X' icon.

3. Select **OK** to save or select **Cancel** to cancel the changes.

Users

Select the **Users** tab to view and edit user settings. The **Users** tab can be used to add or remove local and Active Directory users and preview information about users.

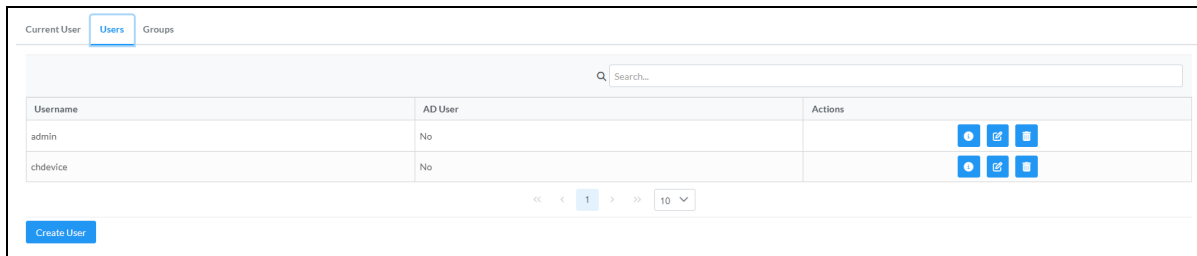

The image shows a web interface for managing users. At the top, there are tabs for 'Current User', 'Users', and 'Groups'. Below the tabs is a search bar labeled 'Search...'. A table lists users with columns for 'Username', 'AD User', and 'Actions'. The table contains two rows: 'admin' and 'chdevice', both with 'No' in the 'AD User' column. The 'Actions' column for each row contains three icons: a magnifying glass, a document with a pencil, and a trash can. Below the table is a pagination control showing '1' of 10 items.

Username	AD User	Actions
admin	No	[Icons]
chdevice	No	[Icons]

Use the **Search Users** field to enter search term(s) and display users that match the search criteria.

If users listed in the **Users** table span across multiple pages, navigate through the list of users by selecting a page number or by using the left or right arrows at the bottom of the **Users** pane to move forward or backward through the pages.

Each page can be set to display 5, 10, or 20 users by using the drop-down menu to the right of the navigation arrows.

Information about existing users is displayed in table format and the following details are provided for each user.

- **Username:** Displays the name of the user.
- **AD User:** Displays whether the user requires authentication using Active Directory.

Select the corresponding icon in the Actions column to view detailed user information or to delete the user.

To create a new user, select **Create User**.

Create a New Local User

1. Select **Create User** in the **Users** tab.
2. In the **Create User** dialog, enter the following:

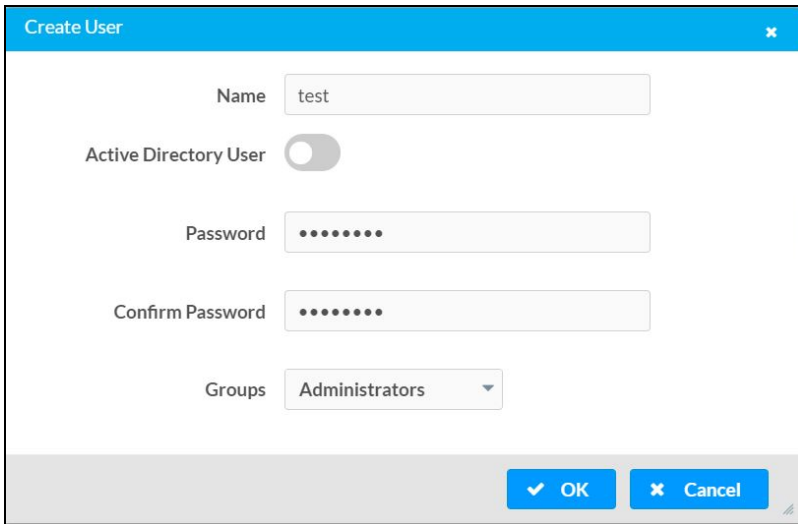

- a. Enter a user name in the **Name** field. A valid user name can consist of alphanumeric characters (letters a-z, A-Z, numbers 0-9) and the underscore "_" character.
- b. Enter a password in the **Password** field; re-enter the same password in the **Confirm Password** field.
- c. Assign the access level by selecting one or more groups from the **Groups** drop-down list.

NOTE: Make sure that the **Active Directory User** toggle is disabled.

3. Select **OK** to save or select **Cancel** to cancel the changes.

Add an Active Directory User

Users cannot be created or removed from the Active Directory server, but access can be granted to an existing user in the Active Directory server.

To grant access to an Active Directory user, you can either add the user to a local group on the DM-NAX-BTIO-1G, or add the Active Directory group(s) that they are a member of to the DM-NAX-BTIO-1G.

To add an Active Directory user.

1. Select **Create User**.
2. In the **Create User** dialog, enter the following.

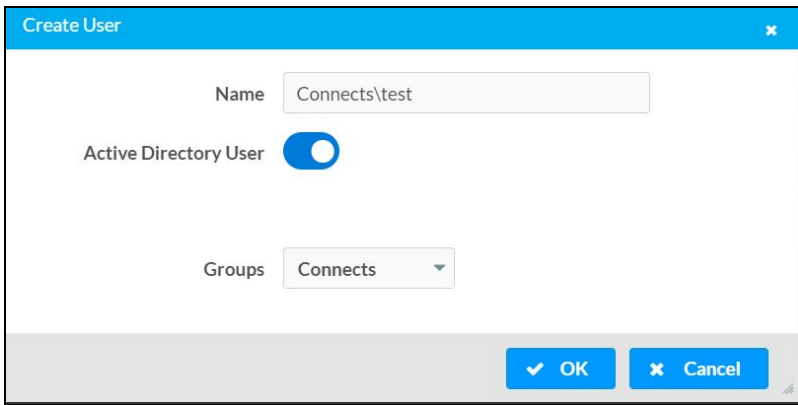

- a. Enter a user name in the **Name** field in the format "Domain\UserName", for example "crestronlabs.com\JohnSmith". Valid user names can contain alphanumeric characters (letters a-z, A-Z, numbers 0-9) and the underscore "_" character.
- b. Select one or more groups from the **Groups** drop-down list.

NOTE: Make sure that the **Active Directory User** toggle is set to enabled.

3. Select **OK** to save or select **Cancel** to cancel the changes.

Delete User

Select the trashcan icon  in the **Actions** column to delete the user. Select **Yes** when prompted to delete the user or **No** to cancel the deletion.

After a user is removed from a group, they lose any access rights associated with that group. Note that the user account is not deleted by the delete user operation.

View User Details

Select the information icon  in the **Actions** column to view information for the selected user. The **User Details** dialog displays the following information for the selected user.

- **Name:** Displays the name of the selected user.
- **Active Directory User:** Displays whether the user is an Active Directory user.
- **Group:** Displays group(s) the selected user is part of.

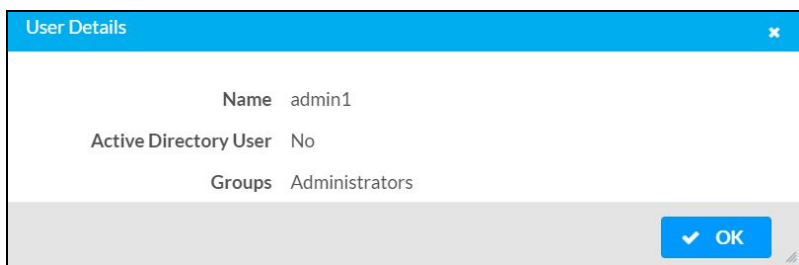

Select **OK** to close the **User Details** dialog and to return to the **Users** tab.

Update User Details

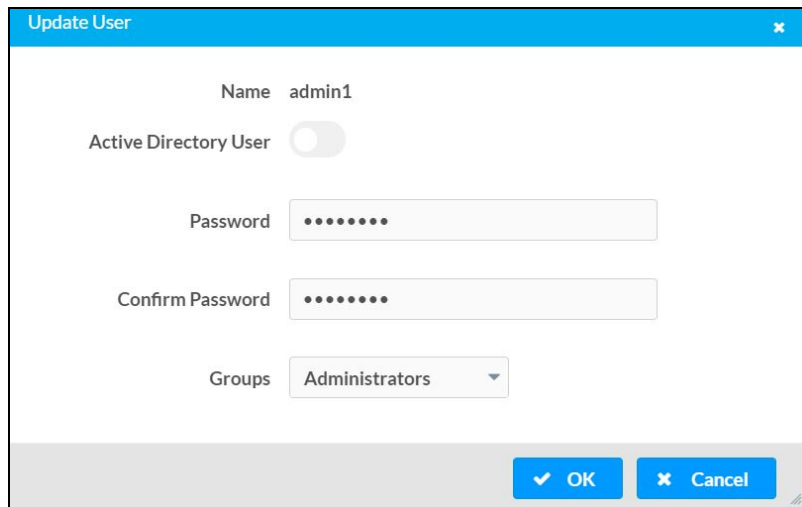

1. Select the edit icon  in the **Actions** column to update information for the selected user.
2. Enter a password in the **Password** field; re-enter the same password in the **Confirm Password** field.
3. Select one or more groups to assign the user to from the **Groups** drop-down list.
4. Select **OK** to save or select **Cancel** to cancel the changes.

The **Update User** dialog also displays the following read-only information for the selected user.









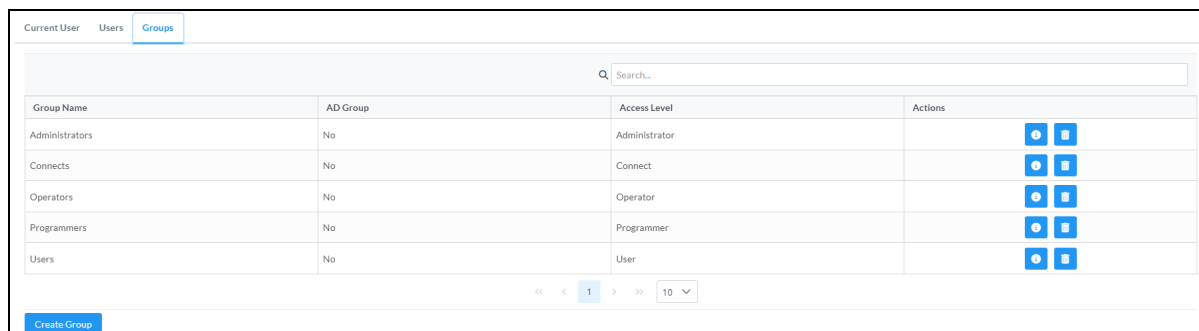

- **Name:** Displays the name of the user.
- **Active Directory User:** Displays whether the user is an Active Directory user.

Groups

Select the **Groups** tab to view and edit group settings. The **Groups** tab can be used to add local and Active Directory groups, remove local and Active Directory groups, and preview information about a group.

Use the **Search Groups** field to enter search term(s) and display groups that match the search criteria.





Group Name	AD Group	Access Level	Actions
Administrators	No	Administrator	 
Connects	No	Connect	 
Operators	No	Operator	 
Programmers	No	Programmer	 
Users	No	User	 

If groups listed in the **Groups** table span across multiple pages, navigate through the groups by selecting a page number or by using the left or right arrows at the bottom of the **Groups** pane to move forward or backward through the pages.

Additionally, each page can be set to display 5, 10, or 20 groups by using the drop-down menu to the right of the navigation arrows.

Existing groups are displayed in a table and the following information is provided for each group:

- **Group Name:** Displays the name of the group.
- **AD Group:** Displays whether the group requires authentication using Active Directory.
- **Access Level:** Displays the predefined access level assigned to the group (Administrator, Programmer, Operator, User, or Connect).

Select the corresponding icon in the **Actions** column to view detailed group information  or to delete  selected group.

Select **Create Group** in the **Groups** tab to create new group.

Create Local Group

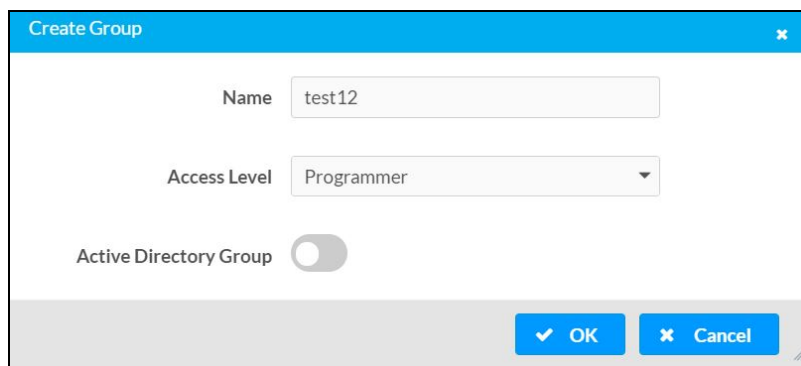

1. Select **Create Group**.
2. In the **Create Group** dialog, enter the following:
 - a. Enter the group name in the **Name** field.
 - b. Assign the group access level by selecting a predefined access level (Administrator, Connect, Operator, Programmer, User) from the **Access Level** drop-down list.

NOTE: Make sure that the **Active Directory Group** toggle is disabled.

3. Select **OK** to save. Select **Cancel** to cancel the changes.

Add Active Directory Group

A group cannot be created or removed from the Active Directory server, but access can be granted to an existing group in Active Directory.

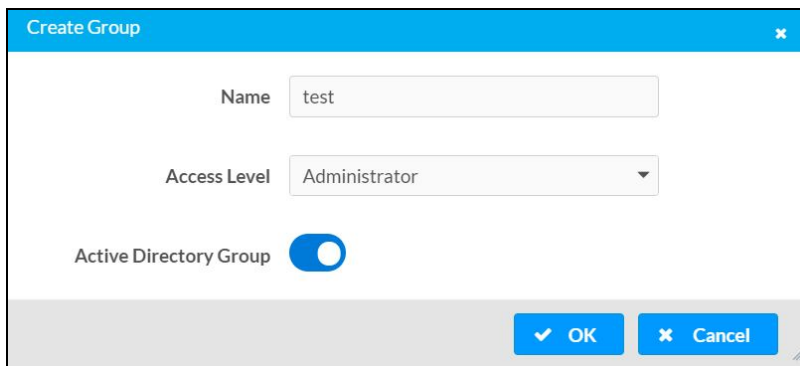

Once the group is added, all members of that group will have access to the DM-NAX-BTIO-1G.

1. Select **Create Group**.
2. In the **Create Group** dialog enter the following:
 - a. Enter the group name in the **Name** field, for example "Engineering Group". Note that group names are case sensitive; a space is a valid character that can be used in group names.
3. Assign the group access level by selecting a predefined access level (Administrator, Connect, Operator, Programmer, User) from the **Access Level** drop-down list.

NOTE: Make sure that the **Active Directory Group** toggle is enabled.

4. Select **OK** to save. Select **Cancel** to cancel the changes.

Delete a Group

Select the trashcan icon  in the **Actions** column to delete a group. Select **Yes** when prompted to delete the group or **No** to cancel the deletion.

When a group is deleted, users in the group are not removed from the device or Active Directory server. However, because a user's access level is inherited from a group(s), users within the deleted group will lose access rights associated with the group.

View Group Details

Select the information icon  in the **Actions** column to view information for the selected group. The **Group Details** dialog lists the following information for the selected group.

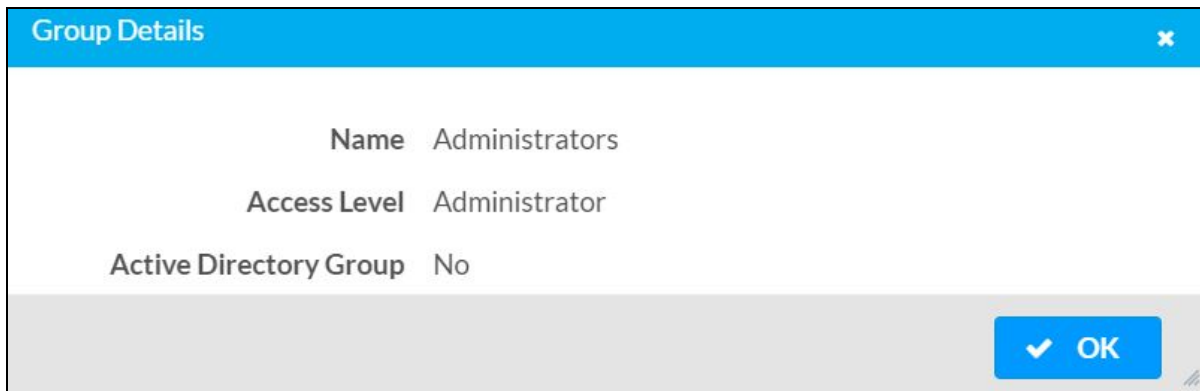

- **Name:** Displays the name of the group.
- **Access Level:** Displays the access level of the group and its users.
- **Active Directory Group:** Displays whether the group is an Active Directory group.

Select **OK** to close the **Group Details** dialog and to return to the **Groups** tab.

802.1x Configuration

The DM-NAX-BTIO-1G has built-in support for the 802.1X standard (an IEEE network standard designed to enhance the security of wireless and Ethernet LANs. The standard relies on the exchange of messages between the device and the network's host, or authentication server), allowing communication with the authentication server and access to protected corporate networks.

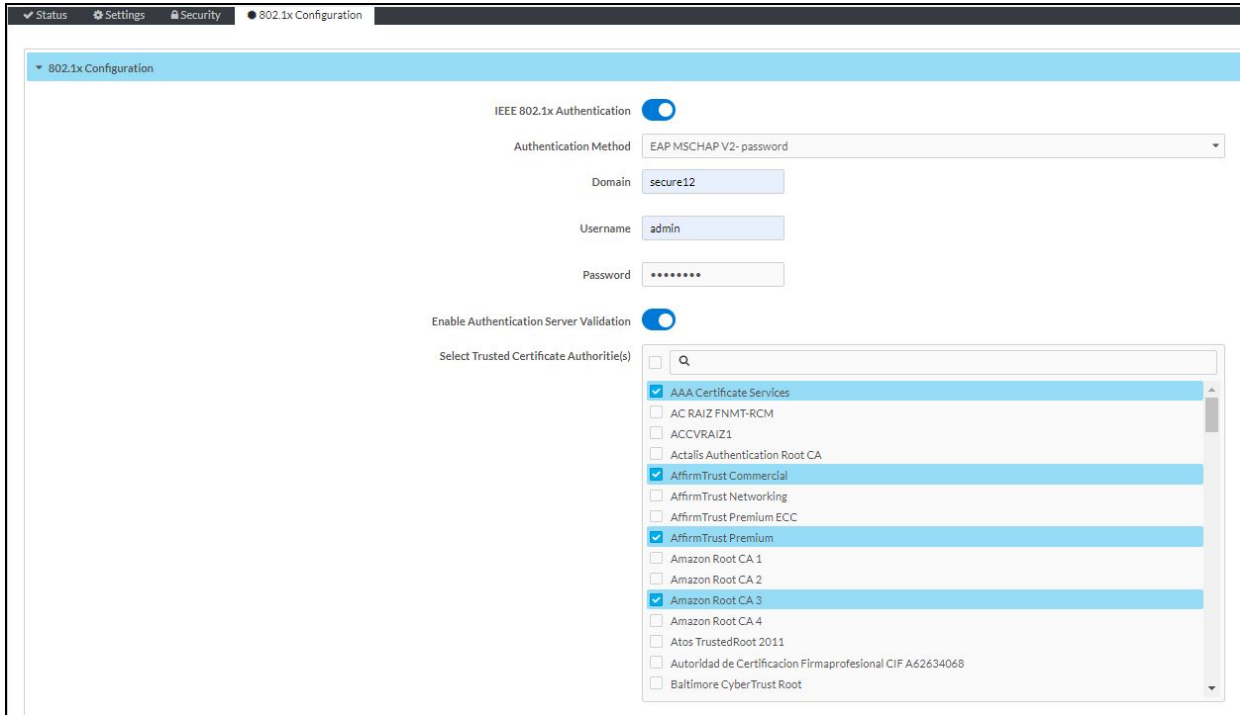

Configure DM-NAX-BTIO-1G for 802.1X Authentication

1. Set the **IEEE 802.1X Authentication** toggle to enabled. This will enable all options on the 802.1X dialog.
2. Select the **Authentication method: EAP-TLS Certificate** or **EAP-MSCHAP V2 Password** according to the network administrator's requirement.
3. Do either one of the following:
 - Select **EAP-TLS Certificate**: Select **Action/Manage Certificates** to upload the required machine certificate. The machine certificate is an encrypted file that will be supplied by the network administrator, along with the certificate password.
 - Select **EAP-MSCHAP V2 Password**: Select the username and password supplied by the network administrator into the **Username** and **Password** fields. This method does not require the use of a machine certificate, only the user name and password credentials.

4. If you enabled the **Enable Authentication Server Validation** option, this will enable the **Select Trusted Certificate Authority(ies)** list box which contains signed Trusted Certificate Authorities (CAs) preloaded into the DM-NAX-BTIO-1G.

Select the check box next to each CA whose certificate can be used for server validation, as specified by the network administrator.

If the network does not use any of the listed certificates, the network administrator must provide a certificate, which must be uploaded manually via the **Manage Certificates** functionality.

5. If required, type the domain name of the network in the **Domain** field.
6. When the 802.1X settings are configured as desired, select **Save Changes** to save the changes to the device and reboot it. Select **Revert** to cancel any changes.

Audio-over-IP Network Design

A Crestron DM NAX® audio-over-IP (AoIP) digital audio distribution system routes and manages local audio sources as well as cloud-based streaming services over standard gigabit Ethernet infrastructure. The DM NAX AoIP platform is based on AES67 standards, and is interoperable with third-party AES67 devices for added flexibility and scalability. DM NAX AoIP network traffic is multicast by design, so careful and thorough network design is critical to a successful deployment. For a proper installation of a DM NAX AoIP audio distribution system, refer to the best practices that follow.

NOTE: Additional content pertaining to systems with DM NVX® AV-over-IP traffic is available in the [DM NVX AV-over-IP System Design Guide](#).

Minimum Network Requirements

Several network switch hardware and firmware features are required in order for an install to successfully support DM NAX AoIP.

- Required network switch features and settings:
 - 1 Gbps port for each connected DM NAX endpoint
 - Non-blocking backplane
 - Layer 3
 - IGMPv2 snooping
 - IGMPv2 Querier
 - Fast-Leave (also known as immediate leave)
- Recommended network switch settings:
 - Layer 3 packet prioritization (DSCP) for Quality of Service (QoS)

NOTE: This should be considered a hard requirement for any systems with mixed DM NAX and DM NVX traffic

- Inter-switch uplink requirements (if needed)
 - Must have sufficient bandwidth for all encoder and decoder traffic to be passed along the uplink (allocate 1 Gbps of traffic per device)

Network Design Overview

DM NAX networks should be designed to isolate traffic on network segments specifically configured to handle DM NAX AoIP and DM NVX A/V-over-IP (AVoIP) traffic. This can be accomplished by using separate infrastructure or Virtual Local Area Networks (VLANs). DM NAX network segments may carry DM NAX multicast streams, DM NAX control, and/or other ancillary traffic.

NOTE: DM NAX devices do not support VLAN tagging, so only DM NAX devices with dual Ethernet ports can be used in conjunction with VLANs to fully isolate DM NAX AoIP traffic from other traffic types on a single network switch.

DM NAX devices with dual Ethernet ports can be configured to isolate network traffic so that one port is designated for control and media player traffic and the other port is designated for AoIP traffic.

- When this **Port Isolation** feature is enabled, connect the control and media player port to the same network segment as the control system. This port will also need Internet access in order to support network streaming services.
- Connect the AoIP port to the network segment that will handle AoIP and AVoIP streams, such as DM NAX audio, AES67 audio, or DM NVX AVoIP streams.

These segments can be handled via VLANs or physically separate switching hardware. If the AoIP traffic is relegated to separate network switches, only the AoIP network switches need to meet the **Minimum Network Requirements** listed above.

Networked AV devices other than DM NAX AoIP devices can be placed on the DM NAX AoIP network segment. The network bandwidth requirements will often be higher in this case, so ensure that the network hardware can support the bandwidth of both platforms. When AV devices such as DM NVX AVoIP endpoints are added to the network, it may be necessary to configure QoS settings such as DSCP priorities on the network switch. Refer to [Quality of Service Configuration on page 635](#) for further information.

A single DM NAX AoIP device can have several network addresses:

- One IP address is required for device control, web configuration, and console access.
- A discrete multicast address is required for each multicast stream transmitting from the device:
 - DM NAX devices will typically have a multicast transmit stream available for each local source and media player on the device, but may also have additional transmit streams called **Parallel Zone Outputs** that mirror the audio signal of the local outputs of the device. For example, the DM-NAX-8ZSA has 8 transmit streams for the local inputs, 8 transmit streams for the local media players, and 8 **Parallel Zone Output** streams, for a total of 24 DM NAX transmit streams, each of which will require its own multicast address. Be sure to account for all available transmit streams of each DM NAX device when allocating multicast address ranges for DM NAX devices.
 - During device configuration, the **Commissioning** function in the web user interface (UI) will automatically assign multicast addresses to the transmit streams in a specified address range. Alternatively, each transmit stream address can be assigned manually via the web UI or custom programming. Duplicate multicast addresses are not permissible, and will cause network collisions and unpredictable behavior at the receiving device. The **Commissioning** function prevents address duplication on a single DM NAX device, and Crestron Home® OS automatically manages multicast addressing on all DM NAX and DM NVX devices in a system to prevent duplicate addresses.

The DM NAX network segment must receive network services, including DNS, DHCP, Active Directory®, PTP, mDNS, and RADIUS services. Coordinate with IT staff to provide access to these services and to create the proper routes for the DM NAX network segment.

Multicast Network Traffic

DM NAX AoIP devices send and receive audio as multicast network traffic. This Internet Group Management Protocol (IGMP) multicast traffic replaces a fixed switching architecture to achieve AoIP audio distribution.

To implement DM NAX devices successfully, first segregate DM NAX traffic away from customer-facing networks with wireless access points and/or Internet access. This can be accomplished either via VLANs or physically-separate switching hardware. In a network segment with multicast traffic, if traffic is not managed, all ports can be flooded by IGMP packets at any time, regardless of whether that traffic was intended to be received by the network device on that port. This leads to interference with network operation and can even be a means of implementing a denial-of-service attack on a network if done maliciously.

To ensure that only traffic between intended multicast senders and multicast receivers is present on a given port, IGMP Snooping must be supported and enabled on the network switch. IGMP Snooping is a feature that enables a network switch to limit multicast traffic only to ports between intended senders and receivers. DM NAX AoIP supports both versions of IGMP snooping: IGMPv2 and IGMPv3.

An IGMP Querier must also be available and enabled to ensure the network switch knows which ports should or should not receive multicast traffic. In a multiswitch topology, the switch with the lowest numerical IP address on the network is typically the default IGMP Querier. Only one IGMP Querier should be enabled and selected on a network. The default leave time for the IGMP Querier (typically 125 seconds) is sufficient for a DM NAX network.

Precision Time Protocol

Precision Time Protocol (PTP) is a clock synchronization protocol that keeps signal clocking aligned throughout a network. This is a crucial component of AoIP audio distribution, since it keeps audio synchronized and transmitting properly between networked audio devices in the system. Many interactions that are part of PTP are extremely time critical, and allow the protocol to achieve submicrosecond accuracy between networked clocks. This also makes PTP traffic extremely sensitive to high-bandwidth traffic if not managed properly.

PTP is multicast traffic, and needs to be able to reach all DM NAX or AES67-capable devices on a network in order to maintain clock synchronization. To keep units synchronized, a single clock in the system is designated as the **PTP Leader Clock**, and all other clocks in the system synchronize to that device's clock. This can be a DM NAX or AES67 AoIP device, or it can be a dedicated clock on the network. The leader clock assignment is decided based on a priority value associated with the clocks on the network:

- DM NAX devices have a default priority of 254, and can be elected as the leader clock only if all other devices on the network have a priority of 254 or 255.
- Any device with a priority value less than 254 would be assigned as the leader clock over a DM NAX device unless the DM NAX device was set to a lower value via the web UI. It is recommended to leave the clock priority value of DM NAX devices at its default value to allow a dedicated PTP clock on the network to be assigned as the leader.

Once a leader clock is selected, all other clocks on the network will be synchronized to that device. In the event that a leader clock becomes inaccessible, a new leader clock will be elected instantly. If network bandwidth becomes saturated and clock synchronization is compromised, noticeable drops in audio quality, broken routes, or audible distortions will occur. If these symptoms are occurring, enable QoS settings on the network switch to preserve consistent clock synchronization and good audio quality.

PTP packets also include a discrete Time To Live (TTL) value. TTL is a value which determines how many network router hops a given packet can traverse before it is discarded by the router. DM NAX PTP packets have a TTL value of 1, meaning the PTP traffic will not survive traversal through a router to another subnet. As a result, all DM NAX traffic must be relegated to a single subnet.

Quality of Service Configuration

Quality of Service (QoS) refers to a suite of features on network switches that are designed to preserve network traffic integrity in the event of compromising circumstances, such as bandwidth saturation. QoS is typically a mechanism of organizing different network traffic types hierarchically, so higher priority traffic has a better chance of being undisturbed by suboptimal network performance (at the expense of lower priority traffic). Configuring QoS can help ensure that time-critical events like PTP clock synchronization between AoIP devices do not fail, even as a network switch handles high utilization rates from surges in traffic bandwidth. Configuring QoS is necessary in VLANs that combine both DM NAX AoIP and DM NVX AVoIP traffic, since constant high-bandwidth traffic will be the standard for most ports on the VLAN.

DM NAX devices tag outgoing traffic with Differentiated Services Code Point (DSCP) headers as shown in the following table:

Prioritization	Traffic Type	DSCP Value
Highest	Time-critical PTP events	CS7 (56)
↓	Remaining PTP traffic	CS6 (48)
	Audio	EF (46)
Lowest	Other	BestEffort (0)

NOTES:

- DM NAX traffic is tagged with DSCP values, not 802.1P IP Precedence values.
- These DSCP values vary slightly from the AES67 standard so that DM NAX PTP and audio traffic can more easily be set to higher priorities than the values corresponding to DM NVX video traffic.
- VLAN tagging is not supported on DM NAX devices.

Mixed DM NAX and DM NVX Network Segment

Quality of Service

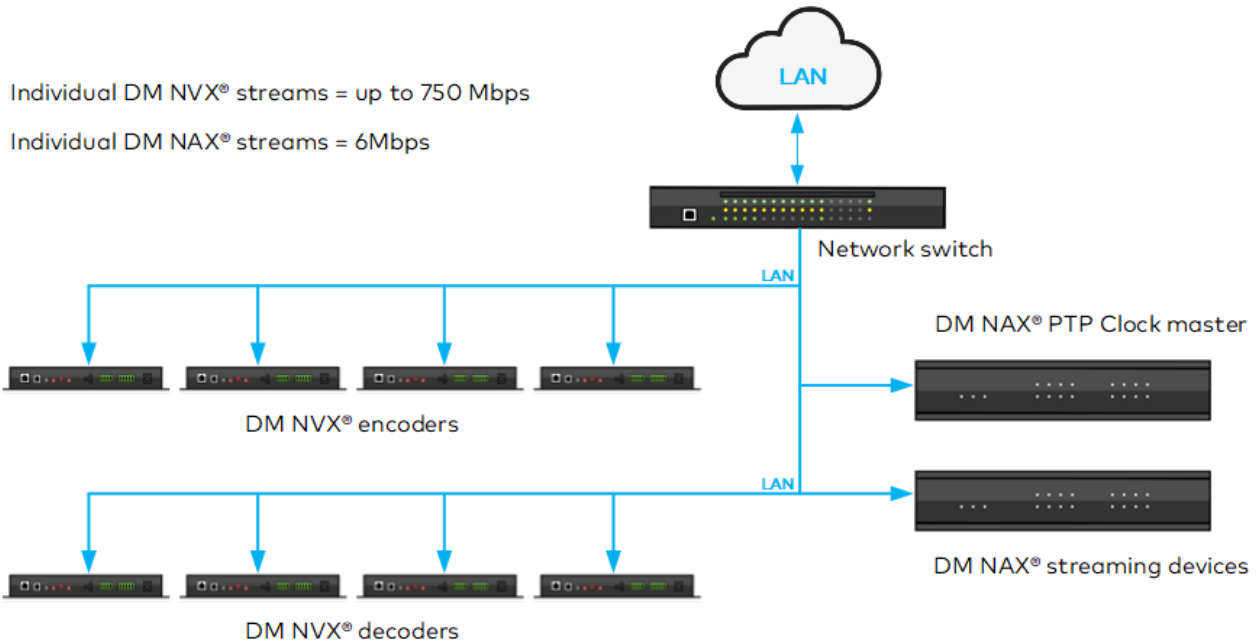

With the potential for DM NVX, AES67, control, and USB traffic to be passing on individual switch connections in a mixed DM NAX and DM NVX VLAN, any given port may approach or exceed 80% utilization (assuming 1 Gbps ports), at which point QoS can prioritize time-critical PTP negotiations. This prevents leader clock status or synchronization from being interrupted during near network saturation. Without QoS configuration, as port utilization approaches the point of saturation, PTP may no longer remain synchronized and audio signals throughout the network may begin to falter, distort, or cut out

completely. QoS cannot fabricate additional bandwidth for the network switch: in the event of true bandwidth saturation, QoS settings cannot guarantee the timely delivery of high-priority traffic.

Network Topologies

The relationships between network switches and their interconnection define a network's topology. In a topology with multiple interconnected switches, there are two classes of network switches: edge switches and core switches.

- Edge switches are connected via uplinks to other switches and routers, and typically have lower backplane bandwidth or processing power.
- Core switches are switches to which edge switch uplinks connect, aggregating and managing traffic from the network's edge. As such, core switches must have sufficient bandwidth and processing power to manage all network traffic from all connected switches.

Connect devices such as control processors, touch screens, servers, personal computing devices, and DM NAX endpoints directly to network switches. In a large network with multiple layers of switch hierarchy, connect these devices to edge switches.

The following general rules apply for determining nonblocking switch fabric bandwidth:

- The network core must support a fabric bandwidth and uplink speed equal to 1 Gbps multiplied by the lesser of the total number of anticipated encoder endpoints or the total number of anticipated decoder endpoints. DM NAX devices can act as both encoders and decoders simultaneously, while DM NVX devices may only operate as one or the other. Include any USB extenders in the endpoint count as well.
- The network edge must support a fabric bandwidth and uplink speed equal to 1 Gbps multiplied by the greater of the total number of anticipated encoder endpoints or the total number of anticipated decoder endpoints. Include any USB extenders in the endpoint count as well.

Star

The basic recommended network topology for a DM NAX system is the star topology. Using a fully nonblocking switch, star topology allows any combination of one or more endpoints to connect to any other combination of endpoints.

The network switch in a star topology must support a backplane bandwidth greater than or equal to 1 Gbps multiplied by the total number of anticipated transmitting endpoints or receiving endpoints, whichever is greater.

Star Topology Using a Nonblocking Network Switch

Star Network Using a Nonblocking Switch

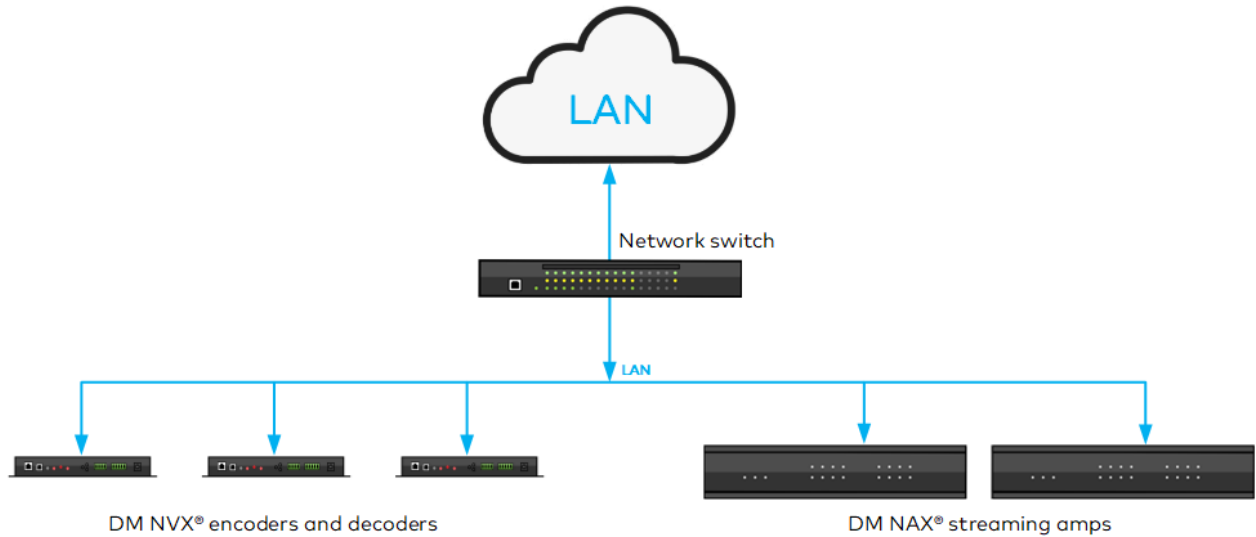

Tree

A tree network is a combination of more than one star network existing on a core switching infrastructure. The tree network allows for failure in one attached star network without widely effecting the others. Configure the network core switch for redundancy and scalability.

In a network with multiple layers of switch hierarchy, always connect DM NAX devices to edge switches. Network edge switches are connected via uplinks to other switches and routers that form the network's core. The core switch fabric and uplinks in a tree topology must support a bandwidth greater than or equal to 1 Gbps multiplied by the total number of anticipated endpoints that will transmit through the core switch.

Each edge switch in a tree topology must support a backplane bandwidth greater than or equal to 1 Gbps multiplied by the total number of anticipated transmitting endpoints or receiving endpoints local to that switch, whichever is greater.

Tree Topology Using Nonblocking Switches on a Core Network

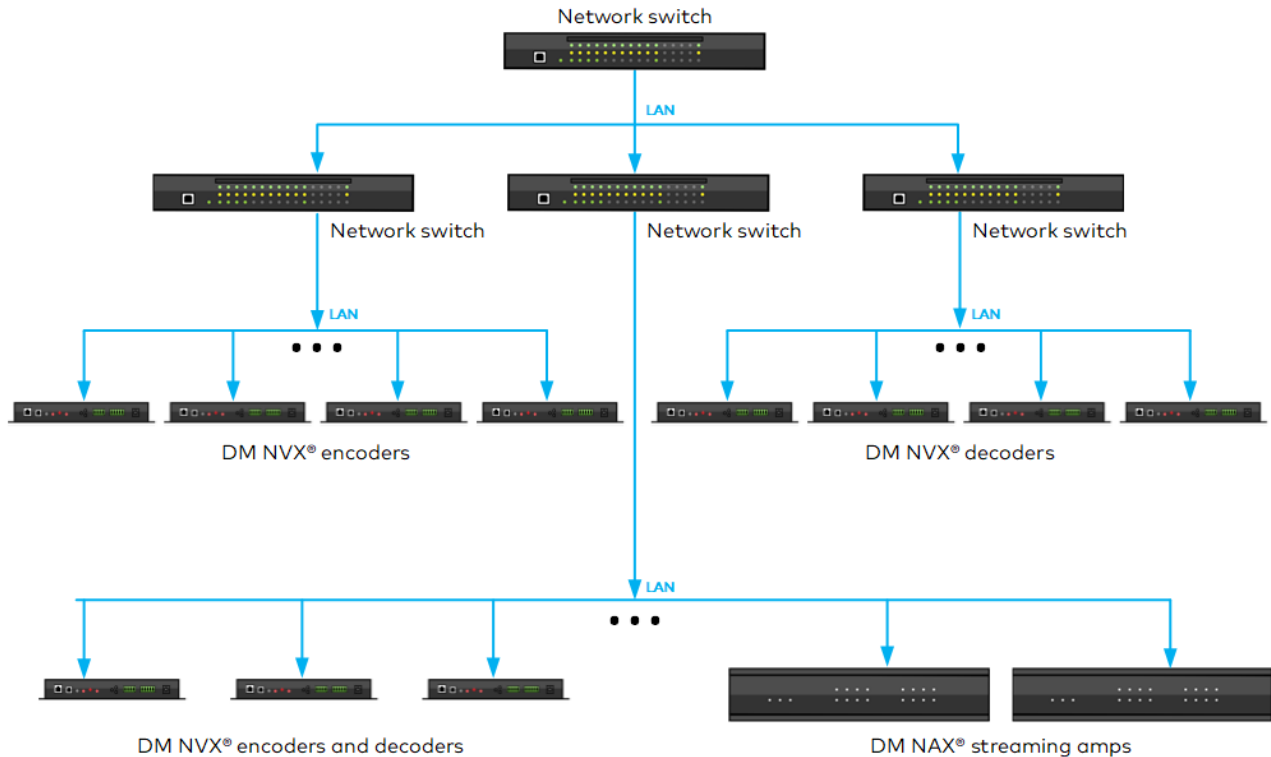

Network Security

Security requires the support of particular capabilities within all devices on the network. DM NAX networks employ:

- 802.1X authentication to ensure that devices on the network have been authorized by the network administration team.
 - Unauthorized devices are prevented from being added to the network and from having access to sensitive content.
- Active Directory services for endpoint administration to ensure that administrative privileges for DM NAX devices can be centrally managed, granted, and revoked when necessary.
- SSL-based Secure Cresnet over IP (SCIP) for control to allow control processors and DM NAX devices to communicate with the intended party device, and that any unauthorized device on the network cannot monitor commands or status.
- SSH-based command-line console access for device configuration and status to protect the device console from access by unauthorized users.

SCIP and SSH-based command-line console access are automatically configured within DM NAX devices and support software. Designs will need to facilitate 802.1X and Active Directory service support within the network.

For additional information about the secure deployment of Crestron products, refer to the [IP Considerations Guidelines for the IT Professional Design Guide](#) and [OLH article 5571](#).

Network Design Considerations

Adhere to these best practices when designing a DM NAX network:

- Use nonblocking Layer 3 switches with port-based QoS at all stages of the design:
 - Ensure sufficient switch fabric bandwidth and port speeds.
- Configure QoS to ensure prioritization of time-critical PTP clock traffic:
 - PTP events are tagged with DSCP values at DM NAX devices so PTP events can successfully pass on the network even at near saturation traffic levels, and clock synchronization is not interrupted between audio devices.
- Enable an IGMP Querier on at least one switch in the DM NAX network.
- Choose an appropriate network topology:
 - Consider the network, including basic functionality and redundancy, as well as whether additional features such as DM NVX video walls or repetitive display signage are necessary.
 - Ensure that network IT staff and network architects are involved in the decision.
- In multiswitch designs, choose switches with sufficient bandwidth at each segment from edge to core to ensure a fully non-blocking design.
- Consult the network switch manufacturer's documentation to confirm that any uplinks are configured properly for multicast traffic.
 - Refer to [OLH article 2948](#) for further considerations when configuring Link Aggregation Groups (LAGs).
- Use Active Directory for network security:
 - Create an Active Directory group responsible for device administration.
 - Add device administrators to the group.
 - Add the group to the DM NAX device via the **Device** tab of the web UI.
- Use a DHCP server with link-layer filtering, and configure the IP addresses of endpoints using DHCP rather than static IP addressing.
 - Using a DHCP server with short lease times, MAC address filtering, and sufficient address space for future needs makes network management simpler.
- Enable IGMP Snooping on the network switch.
 - This is a requirement for all designs, and enables multicast traffic delivery to DM NAX endpoints. Without IGMP Snooping enabled, switches that receive a multicast stream will transmit that stream to all ports simultaneously, which may saturate all network links.
- Use Rapid Spanning Tree Protocol (RSTP) on the network to ensure that network loops are discoverable and to prevent deployment issues.
 - Network management should account for RSTP discovery downtime when changes are made to the network.
- Disable the IGMP proxy function on Crestron control systems on the network that have a built-in router to ensure that DM NAX multicast traffic does not interfere with the control processor.
 - Refer to [OLH article 1001644](#) for instructions on disabling the IGMP proxy function.

- Ensure that multicast IP addresses do not overlap and do not share multicast MAC addresses.
 - Overlapping addresses will cause network collisions and prevent successful operation of the DM NAX network.

System Installation

The installation phase of DM NAX network deployment has its own set of best practices to ensure optimal performance and longevity.

Endpoint Installation

Each DM NAX endpoint has unique installation requirements that vary depending on:

- Quantity of RJ-45 connectors:
 - Single Ethernet port models cannot isolate AoIP and control traffic.
 - Dual Ethernet port models can either share all traffic between both ports or dedicate one port to AoIP traffic, segmenting the remaining traffic to the other port, via the **Port Selection** feature.
- Local I/O capabilities:
 - Some local I/O signal types require close proximity to the connected source or sink.
 - Some signal types, such as unbalanced line-level analog audio, are more susceptible to interference from other devices, especially from AC power lines.
 - Wireless communications such as Bluetooth audio may require unobstructed line-of-sight between transmitter and receiver for optimal performance.
- Amplification, form factor limitations, and channel count requirements.
- Versiport capabilities.

DM NAX devices with dual Ethernet ports can pass the control LAN through to a Crestron touch screen on the secondary Ethernet port when the **Port Selection** feature is disabled.

To minimize required maintenance on an installation:

- Avoid direct access to the endpoint by end users, as they can induce failures or create a security risk due to unauthorized network access.
- Use shielded or unshielded CAT5e (or greater) copper network cable that is properly terminated with an RJ-45 connector and tested for both continuity and throughput.
- Observe the minimum bend radius and maximum pull force of cables to maintain cable integrity.
- Use plenum rated cables in plenum spaces:
 - Fire rated conduit for any fiber or copper cabling used in plenum spaces is also suitable.
- Practice good cable dressing.
- Use descriptive names for endpoints, either through the web UI or Crestron Toolbox™ software; do not rely on default names or the Crestron IP ID.
- Physically secure the endpoint to a fixed point or rack to prevent movement over time.

- Thoroughly document the installation of endpoints, including diagrams, lists, and descriptions to provide detailed information for those who will maintain or upgrade the network.

Network Installation

The success of a DM NAX network installation varies depending on several factors of the physical install, including whether existing network infrastructure is being reused or the location of networking equipment relative to the DM NAX and DM NVX endpoints.

For optimal installation and maintenance of a DM NAX network, adhere to these best practices:

- Use or repurpose existing infrastructure as possible in DM NAX network installation.
- Practice physical security for the network:
 - Secure all network locations (MDF/CDF and IDF down to individual closets) from unauthorized access.
- Disable any unused ports on network switches.
- Use a structured cabling approach, such as those described in the TIA/EIA-568 standard:
 - Include keystones in jacks and patch panels, shielded or unshielded solid copper conductor cable not exceeding 295 ft (90 m), and patch cables not exceeding 33 ft (10 m) to connect between patch panels.
 - Use cable testers to verify the integrity of the installation and capacity for future expansion and backup.
- Use Crestron recommended switch configuration files when possible.
 - Refer to [OLH article 1000314](#) for network switch configuration files that have been shown to meet the minimum requirements for DM NVX deployments; not all of these files have been tested with mixed DM NAX and DM NVX environments. Contact Crestron True Blue Support to confirm if a network switch will support a mixed DM NAX and DM NVX environment.
 - Refer to [OLH article 2836](#) for instructions on configuring NETGEAR® AV network switches to use the built-in DM NAX and DM NVX profiles.
- Configure the routing of any external servers:
 - If non-dedicated DHCP, RADIUS, Active Directory, or other servers are used, ensure that these servers can reach the DM NAX network.
- Thoroughly document all DM NAX network hardware and configurations.

Resources

The following resources are provided for DM NAX®.

NOTE: You may need to provide your Crestron.com web account credentials when prompted to access some of the following resources.

Crestron Support and Training

- [Crestron True Blue Support](#)
- [Crestron Resource Library](#)
- [Crestron Online Help \(OLH\)](#)
- [Crestron Training Institute \(CTI\) Portal](#)

Programmer and Developer Resources

- help.crestron.com: Provides help files for Crestron programming tools such as SIMPL, SIMPL#, and Crestron Toolbox™ software
- developer.crestron.com: Provides developer documentation for Crestron APIs, SDKs, and other development tools

Product Certificates

To search for product certificates, refer to support.crestron.com/app/certificates.

