



McIntosh Laboratory, Inc. 2 Chambers Street Binghamton, New York 13903-2699 Phone: 607-723-3512 www.mcintoshlabs.com

MT100

Integrated Turntable

Owner's Manual





Important Safety Information is supplied in a separate document “Important Additional Operation Information Guide”

FCC Information (For US Customers)

1. IMPORTANT NOTICE:

DO NOT MODIFY THIS PRODUCT

This product, when installed as indicated in the instructions contained in this manual, meets FCC requirements. Modification not expressly approved by McIntosh may void your authority, granted by the FCC, to use the product.

2. CAUTION:

- To comply with FCC RF exposure compliance requirement, separation distance of at least 20cm must be maintained between this product and all persons.
- This product and its antenna must not be co-located or operating in conjunction with any other antenna or transmitter.

3. COMPLIANCE INFORMATION:

- Product Name: Integrated Turntable
- Model Number: MTI100
- **This product contains FCC ID: SSS-BC11X:**
McIntosh Laboratory, Inc.
2 Chambers Street
Binghamton, NY 13903
Tel. (607) 723-3512

IC Information (For Canadian Customers)

1. PRODUCT:

This product contains IC : 11012A-BC11X

This product complies with RSS-210 of Industry Canada. Operation is subject to the following two conditions: (1) this product may not cause harmful interference, and (2) this product must accept any interference received, including interference that may cause undesired operation. This Class B digital apparatus complies with Canadian ICES-003.

2. CAUTION:

To reduce potential radio interference to other users, the antenna type and its gain should be so chosen that the equivalent isotropically radiated power (e.i.r.p.) is not more than that permitted for successful communication.

Informations sur IC (pour les clients Canadiens)

1. APPAREIL:

Cet appareil contient IC : 11012A-BC11X

Cet appareil est conforme à la norme CNR-210 du Canada. L'utilisation de ce dispositif est autorisée seulement aux deux conditions suivantes : (1) il ne doit pas produire de brouillage, et (2) l'utilisateur du dispositif doit être prêt à accepter tout brouillage radioélectrique reçu, même si ce brouillage est susceptible de compromettre le fonctionnement du dispositif. Cet appareil numérique de la classe B est conforme à la norme NMB-003 du Canada.

2. ATTENTION:

Afin de réduire le risque d'interférence aux autres utilisateurs, il faut choisir le type d'antenne et son gain de façon à ce que la puissance isotrope rayonnée équivalente (p.i.r.e.) ne soit pas supérieure au niveau requis pour l'obtention d'une communication satisfaisante.

Canadian Customers: CAN ICES-003 (B)/NMB-003 (B)

RF Exposure Information

This equipment complies with FCC/IC radiation exposure limits set forth for an uncontrolled environment and meets the FCC radio frequency (RF) Exposure Guidelines in Supplement C to OET65 and RSS-102 of the IC radio frequency (RF) Exposure rules. This equipment has very low levels of RF energy that are deemed to comply without testing of specific absorption ratio (SAR).

Cet équipement est conforme aux normes d'exposition aux radiations FCC/IC définies pour un environnement non contrôlé et satisfait les directives d'exposition à la radiofréquence (RF) dans le supplément C des OET65 et RSS-102 des règles d'exposition à la fréquence radio (RF) IC. Cet équipement a de très faibles niveaux d'énergie RF qui sont jugés conformes sans test de taux d'absorption spécifique (SAR).

R&TTE(EN) Information

1. DECLARATION OF CONFORMITY

Our products follow the provisions of EC/EU directives:
LV: 2006/95/EU
EMC: 2014/30/EU
RoHS: 2011/65/EU
ErP: EC regulation 1275/2008 and its frame work directive 2009/125/EC

2. IMPORTANT NOTICE:

DO NOT MODIFY THIS PRODUCT

This product, when installed as indicated in the instructions contained in this manual, meets R&TTE directive requirements. Modification of the product could result in hazardous Radio and EMC radiation.

3. CAUTION:

Separation distance of at least 20cm must be maintained between this product and all persons.
This product and its antenna must not be co-located or operating in conjunction with any other antenna or transmitter.

Thank you from all of us at McIntosh

You have invested in a precision instrument that will provide you with many years of enjoyment. Please take a few moments to familiarize yourself with the features and instructions to get the maximum performance from your equipment.

If you need further technical assistance, please contact your dealer who may be more familiar with your particular setup including other brands. You can also contact McIntosh with additional questions or in the unlikely event of needing service.

McIntosh Laboratory, Inc.

2 Chambers Street
Binghamton, New York 13903

Technical Assistance: (607) 723-3512

Fax: (607) 724-0549

Customer Service: (607) 723-3515

Fax: (607) 723-1917

Email: support@mcintoshlabs.com

Website: mcintoshlabs.com

Make a Note

For future reference, you can jot down your serial number and purchase information here. We can identify your purchase from this information if the occasion should arise.

Serial Number:	
Purchase Date:	
Dealer Name	

Copyright 2021 © by McIntosh Laboratory, Inc

Table of Contents

Thank you from all of us at McIntosh	3
Make a Note.....	3
Inside the Box	4
Where to Put It.....	4
Keep it Safe.....	4
Putting it Together	4
To install the Tubes.....	4
Install Vacuum Tube Shield Cover	4
Installing the Wi-Fi Antenna.....	5
Installing the Platter.....	5
Already Installed	5
Installing Anti-skate	5
Phono Cartridge Wires	5
Installing the Counterweight	5
Installing the Belt	6
Record Clamps.....	6
Playing a Record.....	6
End of the Record	6
Making Connections	7
Speaker Connection.....	7
Bluetooth Connection	7
More Outputs.....	8
SUB (Subwoofer).....	8
Main.....	8
Trigger Out	8
Data Out.....	8
Inputs	8
Optical and Coax	8
AUX (Auxiliary)	8
Service Port.....	8
AC Power	8
Headphones.....	8
Controlling Your Unit.....	8
Power On (or Off).....	8
Input Knob.....	9
Volume Knob.....	9
About Those Tubes	9

Turntable Maintenance	9
Clean Your Stylus	9
Anti-Skate.....	9
Changing Speeds	9
Belt Pulley- 50Hz Versus 60Hz.....	10
The Cartridge and the Stylus.....	10
Cartridge Alignment.....	10
Dimensions	11
Description of Remote Control Buttons	12
Changing the Remote's Battery	13
Re-packing the MTI100.....	13
Technical Specifications	14
Amplifier	14
Preamplifier	14
Olympia Cartridge.....	14
Tone Arm.....	14
The Table	14
Motor	15
General.....	15
Trademark and License Information	15

List of Figures

Figure 01– Removing Stylus Guard	4
Figure 02– Tube Socket	4
Figure 03– Vacuum Tube Shield Cover.....	4
Figure 04– Anti-Skate Parts.....	5
Figure 05– Rear View Cartridge Pins	5
Figure 06– Counterweight Adjustment.....	5
Figure 07– Top View- Belt and Pulley	6
Figure 08– Rear Panel	7
Figure 09– Insert Speaker Cable	7
Figure 10– Volume and Input Knobs.....	8
Figure 11– Anti-Skate cable.....	9
Figure 12– Belt in 45 rpm position.....	9
Figure 13– Belt in 33 rpm position.....	9
Figure 14– Alignment Jig.....	10
Figure 15– Remote control diagram.....	12
Figure 16– Sliding open the remote	13



Inside the Box

Open the top of the shipping carton.

Remove the top layer of shipping foam.

The next layer of foam will contain:

- Remote Control
- Phono Cartridge Box containing some tools (The Cartridge is already installed)
- AC Power Cord
- Bluetooth Antenna
- Turntable Belt
- Turntable Mat
- 60Hz Pulley (Export only)
- Speaker terminal Wrench
- 2 Vacuum Tubes
- 2 Vacuum Tube Shield Covers
- 3 Allen Wrenches/Hex Keys (Small 1.2mm, Medium 1/16 inch, and Large 5/64 inch)
- This Owner's Manual

Remove this layer of foam.

The MTI100 will be revealed. Carefully, remove the unit and place it on a secure surface.

Under this level will be the Turntable Platter secured between two pieces of protective foam packing.

Where to Put It

A firm and level surface with good isolation is essential for best performance. Optimal record playback is achieved when the turntable is perfectly level. It should also be kept away from the speakers to prevent the cartridge from picking up unwanted vibrations.

Keep it Safe

The Olympia Stylus is both important and delicate.

To protect the Stylus, it is best to leave the Stylus Guard installed while setting up or moving the MTI100. But when the time comes to unleash the Stylus, you can do so by pulling downward. Replace the Stylus Guard by reversing the procedure (see Figure 1).

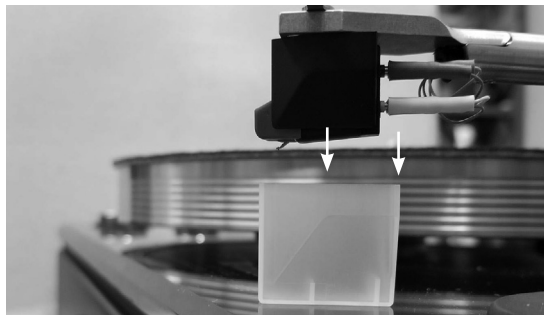

Figure 01– Removing Stylus Guard

Putting it Together

The Tubes

The MTI100 uses a tube driven output stage to exquisitely extract the music from vinyl as well as other analog and digital sources including wireless connections. Two 12AX7 vacuum tubes are expertly matched to the Sumiko Olympia Moving Magnet Cartridge, and combined with ultra-clean circuitry, provide warm balanced and detailed full range performance. Plus the glowing tubes look great.

To install the Tubes

- Carefully line up pins at the bottom of the tube with the 9 pin holes of the Tube Socket (see Figure 2).
- Press downward with even pressure.
- Stop when flush.

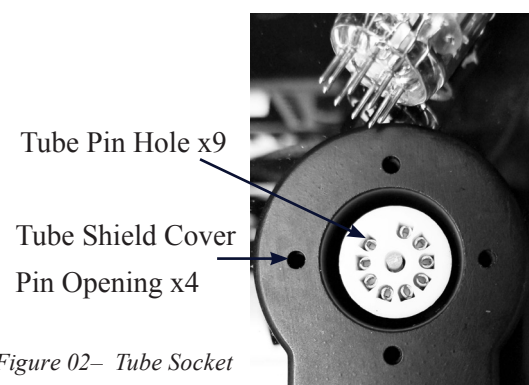

Figure 02– Tube Socket

- Repeat for the second Tube.
- The key is to line up the pins with the holes. You do not want to bend the pins.

Install Vacuum Tube Shield Cover

Two Vacuum Tube Shield Covers are included to help protect the Vacuum Tubes (see Figure 3).

To install:

- Arrange the Vacuum Tube Shield Cover so that the “Mc” in the center is in the right direction.
- Line up the 4 Legs of the Vacuum Tube Shield Cover with the four holes surrounding the Tube Socket (see Figure 2).
- Press the Vacuum Tube Shield Cover into place.
- Repeat for the second cover.

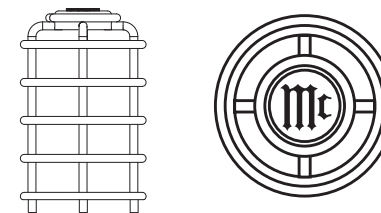

Figure 03– Vacuum Tube Shield Cover

Installing the Wi-Fi Antenna

To install the Wi-Fi antenna, screw the antenna clockwise onto the antenna base located on the left side (looking at the back) of the rear of the MTI100 (Figure 8 on page 7).

Installing the Platter

Near the center of the top of the MTI100, you will find a spindle with a ball bearing. To install the platter, fit the brass fitting located in the center of the bottom of the platter over the spindle. Carefully and evenly seat the platter.

To remove the platter, pull the platter upward, away from the MTI100.

The Record Mat is placed on the Platter as you would a record (centered on the Spindle).

Already Installed

The MTI100 comes equipped with a Sumiko Olympia Phono Cartridge which has already been expertly installed and set up. Anti-skate and the Counterweight have been factory set. The Anti-skate cable needs to be released and placed in the holder. Full instructions are included for possible future reference.

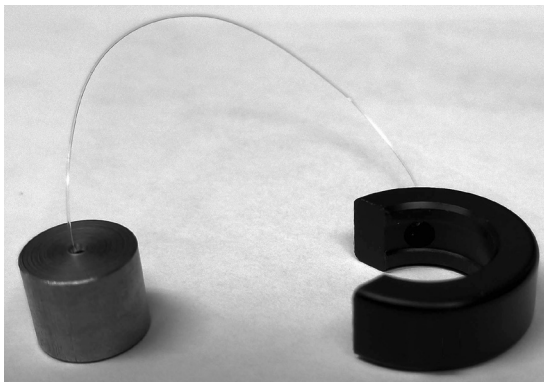

Figure 04– Anti-Skate Parts

Installing Anti-Skate

The Anti-skate Mechanism has been factory installed, and the cable simply needs to be unsecured from its packing and hooked on the holder. Full instructions are included anyway. Skip to the last step in bold below.

The Anti-skate Assembly consists of a black U-shaped anchor connected to a small silver weight by a clear cable (see Figure 4). There is a pre-installed metal cable holder attached to the Tonearm Base.

To install the Anti-skate feature:

- Remove the Counterweight. (See Installing Counterweight below.)
- Slide the black U-shaped end of the Anti-skate Assembly over the rear of the Tone Arm with the Allen Wrench Screw accessible (on the right side of the Tonearm). Leave approximately a 1/4-inch (0.635 cm) between the Tonearm Pivot and the Black U-shaped end. Leaving slightly more space will make no difference in performance. Just make sure there is some space.
- **Slip the clear plastic cable into the gap at the end of the Anti-Skate cable holder. The weight will hang down.** (Figure 11 on page 9.)

This setup is designed for this tone arm and cartridge. No further adjustment is needed.

Phono Cartridge Wires

The wire connections between the tonearm and cartridge are color coded. There are colored rings at the base of the pins on the rear of the cartridge. These are connected to the corresponding colored wires from the tonearm. The four wires terminate in connectors which are slid over small brass

pins. Please use care and an appropriate tool for connecting or disconnecting these wires. Since the Sumiko Olympia Cartridge is already installed, there is no immediate need to touch these wires unless a new cartridge is being installed.

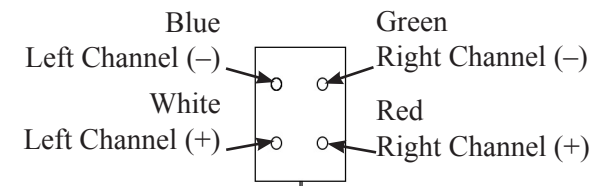

Figure 05– Rear View Cartridge Pins

Installing the Counterweight

The Counterweight has been installed and calibrated at the factory. To make any adjustments, you should have a good quality Stylus Tracking Force Pressure Scale Gauge.

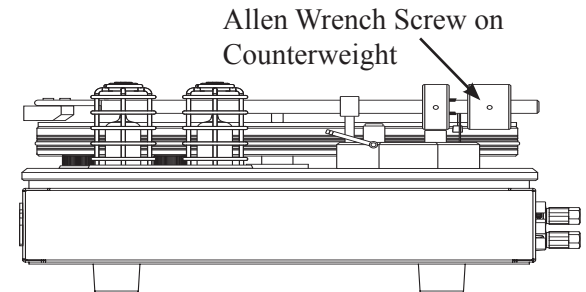

Figure 06– Counterweight Adjustment

To move/remove or install the Counterweight:

- Make sure the Allen Wrench Screw is loosened (see Figure 6). You can loosen the Allen Wrench Screw using the included Medium Allen Wrench- turn the screw counter-clockwise to loosen.
- Position the Counterweight so the Tonearm floats in a position between down and up.

- Gently slide the Counterweight towards the Tonearm Pivot Point so the stylus will rest on your Stylus Tracking Force Pressure Scale Gauge.
- Make fine adjustments to the Counterweight until the desired Tracking Force is achieved. The recommended setting for the included Sumiko Olympia Cartridge is 2.0 grams. Other cartridges may differ.
- Tighten the Allen Wrench Screw by turning clockwise with the Medium Allen Wrench.

Installing the Belt

The Belt must be installed around the Pulley and the Platter. The Pulley has two speed positions for the Belt (Figures 12 and 13 on page 9). The wider position is 45 rpm and the position above is for 33 rpm. To install the Belt:

- Place the Belt below the 45 rpm groove towards the bottom of the Pulley.
- Using two hands, pull the Belt outward following a path beyond the outer edge of the Platter in each direction keeping the Belt as level as you can.

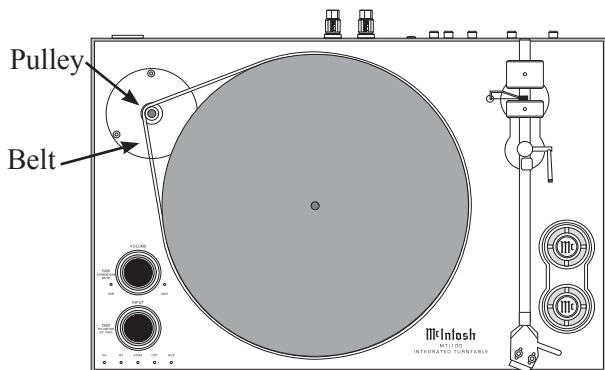

Figure 07– Top View- Belt and Pulley

- With the Belt pulled beyond the diameter of the Platter, rest the Belt on the Platter edge furthest from the Pulley and gently release the Belt so it rests on the Platter’s edge on both sides of this point.
- Lift the Belt to the proper position on the Pulley.
- Turn the Platter to automatically level the Belt.

Record Clamps

Record clamps are used by some to reduce vibrations caused by records that are warped.

If you choose to use a record clamp, it is recommended you do not use a heavy one. Some may think heavier is better, but excess weight will put added strain on the spindle and bearing of the MT1100, and there is no real benefit to doing this. Effective lighter options exist in the world if you wish to employ record clamps.

Playing a Record

- Place a record on the record mat on top of the platter.
- The record should be clean(ed) using your preferred method.
- Select the Phono (PH) Input using the Input Knob or Remote Control.
- Press the Input Knob to start the motor and turn the platter. Note the Input Knob will only turn on the motor with PH selected.
- Place Tonearm Lift in the up position which is with the lever facing up.
- Release the Tonearm from the Tonearm Rest and place it above the start of the record.

- When positioned at the desired point, pull the Tonearm Lift towards you, lowering the Stylus onto the record.

End of the Record

- When the Stylus reaches the end of the record, lift the Tonearm by the handle and place it back in the Tonearm Rest.
- To stop the motor from spinning the platter, push the Input Knob or switch to another input.

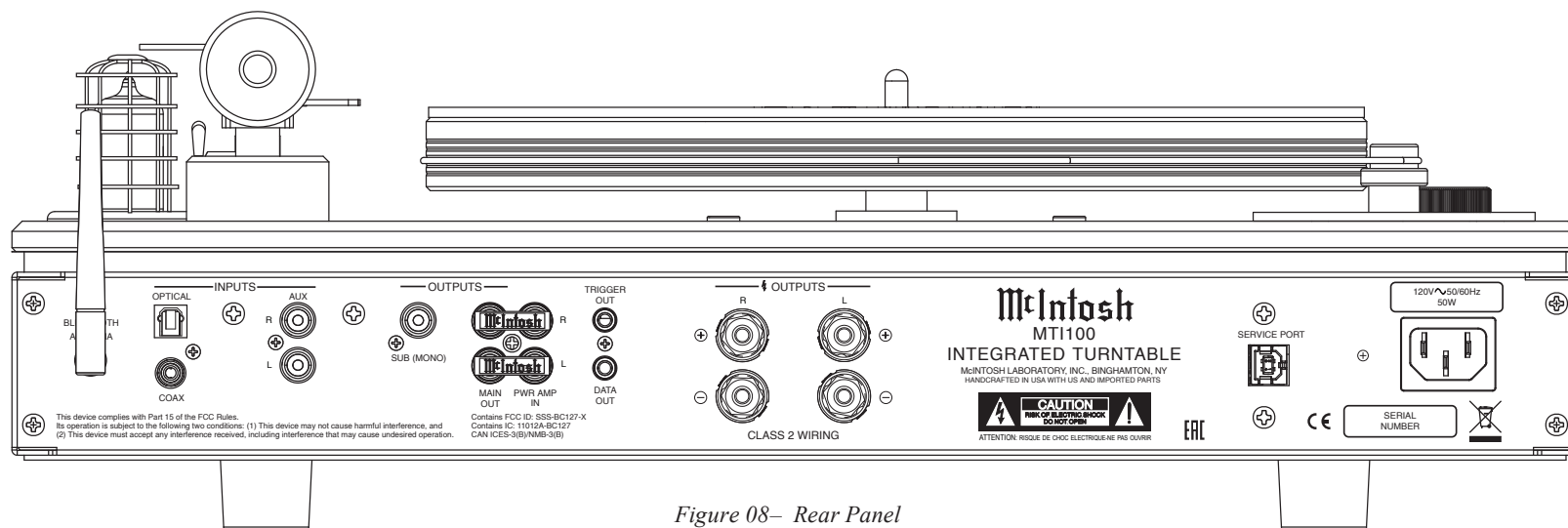

Figure 08– Rear Panel

Making Connections

The rear panel of the MTI100 allows the unit to be connected to speakers, other sources, additional amplifiers, power control, and AC power.

Speakers should be connected before connecting AC power to avoid the **RISK OF ELECTRIC SHOCK** or **DAMAGE**.

Speaker Connection

The goal is to connect the right-side speakers using quality speaker cable (16AWG or heavier) to the right Speaker Output Terminals and the left to the remaining pair of Speaker Output Terminals paying attention to the polarity- Positive (+) to Positive and Negative (-) to Negative.

Loosen the Speaker Output Terminals by turning the top counter-clockwise until a sufficient opening appears to insert the exposed (1/2 inch/12.7 mm) bare wire end (or spade) of the speaker cable.

Hand-tighten the Speaker Output Terminals by

turning clockwise. Then use the supplied McIntosh Wrench to give a final 90 degree turn. Do not over tighten.

In the United States and Canada, banana plugs can be used to connect speakers. First tighten the Speaker Output

Terminals as described above. With speaker cables connected to the banana plug as directed by your banana plug's instructions, insert the banana plug into the center hole of the Speaker Output Terminal paying attention to polarity.

DO NOT combine any of the output terminals. Neither positive to positive (+) nor negative to negative (-) should be attempted. This will cause damage. A subwoofer output is provided with a full-range mono output.

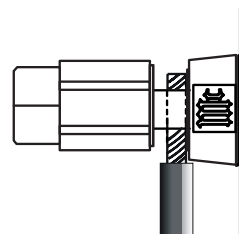

Figure 09– Insert Speaker Cable

Bluetooth Connection

When powered on, the MTI100 is in Bluetooth Discovery mode. You do not need to do anything more to the MTI100 than turn it on. To pair the MTI100, follow the instructions for your Android or iOS device. When pairing, the green “BT” below the Input Knob will flash. Look for **MTI100 HD** in the list of available devices on the device you are pairing.

To initiate a new Bluetooth connection, momentarily Push the Input Knob. This will also disconnect the old Bluetooth connection.

To disable the Bluetooth function, Push and Hold the Input Knob for two seconds. To re-enable, put MTI100 in and out of Standby Mode using the Volume Knob (as described on page 8 under “Power On”).

The MTI100 incorporates HD Bluetooth technology. The implementation of a high-definition codec can provide CD quality music over Bluetooth



connections. If your connected device has this capability, the MTI100 will take advantage of this high-definition connection. The MTI100 will automatically utilize HD Bluetooth when connected to a source that supports it. Simply connect with Bluetooth as above.

The MTI100 also supports higher than CD quality resolution of 24-bit/48kHz. If your connected device supports this, then that resolution will be utilized automatically.

More Outputs

SUB (Subwoofer)

If you wish to add a subwoofer, connect the subwoofer using an RCA cable to the SUB connector. This output is a full frequency mono signal which combines left and right channels 20Hz to 20kHz. Use your external subwoofer's built-in crossover adjustments.

Main

The Main Output allows the use of a separate external power amplifier. To use a separate power amplifier instead of the MTI100's integrated amplifier:

- Remove the McIntosh Jumpers (2) between the MAIN Output and the PWR AMP IN.
- Connect an additional amplifier using RCA cables paying attention to Left (bottom) and Right (top).

If you wish to use both an external amplifier and the MTI100's integrated amplifier, two shielded RCA Type Audio "Y" Adapters can be used. (One adapter for left and one for right). Use 2 of the 3 RCA jacks of the "Y" adapter to jump the MAIN OUT and PWR AMP IN, and the third jack will connect to the external amplifier.

Trigger Out

The TRIGGER OUT is an output that can be connected to other McIntosh equipment using a 3.5mm stereo mini phone plug to send a +12 volt/0 volt signal for power control. This will enable additional equipment to be powered on and off by simply controlling the MTI100.

Data Out

Using a 3.5mm stereo mini phone plug to connect to other components, the DATA OUT can send remote control signals to allow other McIntosh Equipment to be controlled using the MTI100 remote.

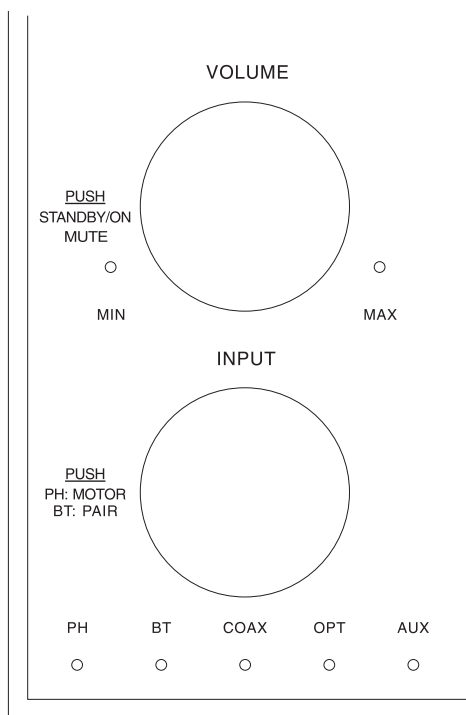

Figure 10– Volume and Input Knobs

Inputs

Optical and Coax

Using an optical cable to connect to OPTICAL or a coaxial cable to connect to COAX, digital signals up to 192kHz with 24-bit resolution can be decoded by the MTI100's internal DAC.

AUX (Auxiliary)

An additional analog source can be added to the MTI100 by connecting a pair of RCA cables to the AUX connectors.

Service Port

The SERVICE PORT enables a USB connection for future firmware upgrades. It is not a USB digital input.

AC Power

Use the included AC Power Cord to connect the MTI100 to a working AC outlet. Make sure the voltage matches the value printed above the AC Connector on the right side of the rear of the unit.

Headphones

On the right side of the front of the MTI100 is a 1/4-inch Headphone Jack. To listen to headphones, plug them into the Headphone Jack. This will mute the other outputs until the headphones are disconnected.

Controlling Your Unit

Power On (or Off)

Pressing the Volume Knob will turn the unit on assuming you have connected the power cable to a working outlet. To place the unit in standby mode, press and hold the Volume Knob for a second and then release.

Input Knob

Turning the Input Knob will scroll between five possible inputs. An LED light will illuminate on the current choice. Input choices are:

- Phono (PH)
- Bluetooth (BT)
- Digital Coax (COAX)
- Digital Optical (OPT)
- Auxiliary RCA (AUX)

Volume Knob

Turn clockwise for more and counter-clockwise for less volume. The volume will be set at the same level as when the unit was turned off though near maximum volumes will be scaled back to avoid possibly unpleasant surprises. When the volume is at the minimum setting, the MIN LED will light. The MAX LED will light when the maximum volume is achieved.

Pushing the Volume Knob will toggle the Mute function on and off. When Mute is engaged, the MIN light will flash. Remember, Pushing and Holding the Volume Knob will place the MTI100 in Standby when the unit is on.

About Those Tubes

The Preamplifier section of the MTI100 features two tubes that can be seen glowing on the right of the turntable. These tubes (12AX7 to be precise) are expertly incorporated into the preamplifier circuit to provide warm detailed playback.

Turntable Maintenance

The platter bearing is lubricated and ready to play out of the box. After a year of use, it is recommended that white lithium grease be applied to the ball bearing on top of the spindle. To do this:

- Remove the turntable belt and carefully lift and remove the platter.
- The ball bearing will be visible on the top of the spindle.
- Apply a small amount of white lithium grease.
- Replace the platter and belt.
- The belt will align itself when the platter turns.

Clean Your Stylus

Peak performance is achieved by maintaining a clean stylus and record surface. A quality record cleaner and stylus brush is recommended. If your records are kept clean, brushing your cartridge will suffice to remove accumulated dust if it is used after each play. Be sure to either turn the volume down or select a different input prior to doing this. Only use a back to front motion when contacting the stylus during cleaning.

Anti-Skate

The force of the needle in the groove will cause the tonearm to want to move (or skate) towards the center of the record. To keep the needle properly centered in the groove an opposite force is applied. This is called anti-skate. Your MTI100 is set up with properly adjusted anti-skate. Make sure the thin cable passes through the metal loop projecting out of the tonearm support. There is a small gap to slip the cable in. No other adjustments are needed.

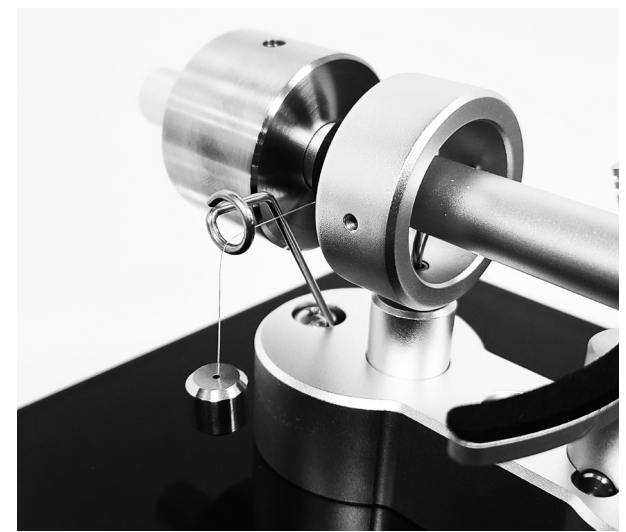

Figure 11– Anti-Skate cable.

Changing Speeds

The MTI100's turntable motor spins at a precise speed. Changing speeds of the platter between 33-1/3 rpm and 45 rpm is achieved by repositioning the belt.

With the turntable stationary, move the belt to the lower, wider part of the pulley for 45 rpm. For 33 rpm, seat the belt just above the wider section.



Figure 12–
Belt in 45 rpm Position



Figure 13–
Belt in 33 rpm Position

Don't worry, the belt will automatically level itself when spinning. A Direct Drive Permanent Magnet AC Synchronous Motor, which is synced to the AC power line's unfluctuating frequency, assures a precise speed is maintained.

Belt Pulley- 50Hz Versus 60Hz

For units shipped in North America, a Belt Pulley designed for 60Hz is installed. For units shipped outside of North America, a 50Hz Belt Pulley is installed. Since some countries use both 50Hz and 60Hz frequencies, a 60Hz Belt Pulley is included in units shipped outside North America. The 60Hz Belt Pulley is the smaller of the two. To change the Belt Pulley, use the supplied Small Allen Wrench to loosen the two bolts at the base of the belt Pulley and then pull upward to remove. Reverse this procedure to install the Belt Pulley.

The Cartridge and the Stylus

Included and installed on the MTI100 is the Olympia Oyster Series Moving Magnet Cartridge which is McIntosh part number 32065000. If the stylus becomes damaged or worn, there is no need to replace the entire cartridge- a new stylus can be ordered (McIntosh part number 310649SP).

Cartridge Alignment

The cartridge has been expertly aligned at our factory. You do not need to align the cartridge when first setting up the MTI100. We do include an Alignment Jig for setting up a new cartridge.

To align a cartridge:

- Remove the record mat for best results.
- Slip the rounded opening on one end of the Alignment Jig around the rounded section of the shaft supporting the tonearm. The Jig will fit just below the more rectangular section with a slight

bend in the Jig. Place the Jig's hole over the record spindle.

- Carefully move the tonearm. The stylus should (gently) land on the dot in the center of the grid pattern, and the edge of the cartridge should be parallel with the grid lines.
- To adjust the cartridge, loosen the two screws holding the cartridge to the cartridge shell. Use the supplied Large Allen wrench. Loosen just enough to be able to make slight adjustments to the cartridge position. Using care (and patience) adjust the cartridge position until the stylus falls on the center dot of the grid pattern and the edge of the cartridge is parallel with the grid lines. Then, tighten the screws.

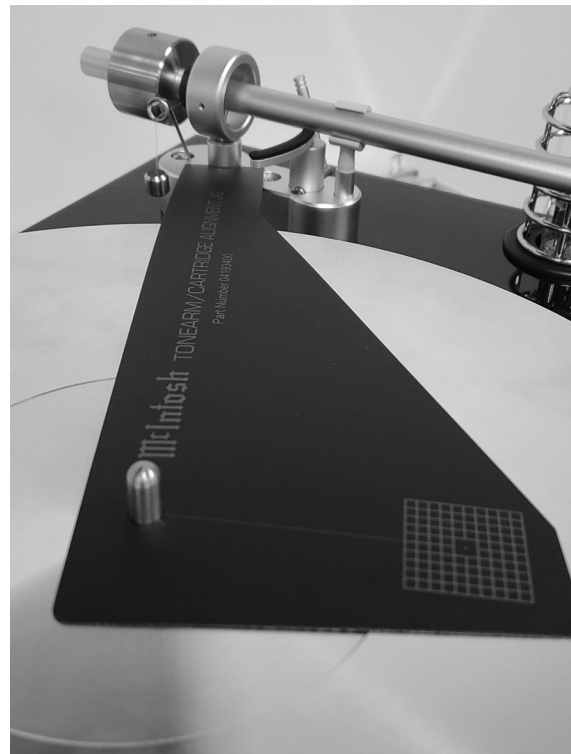
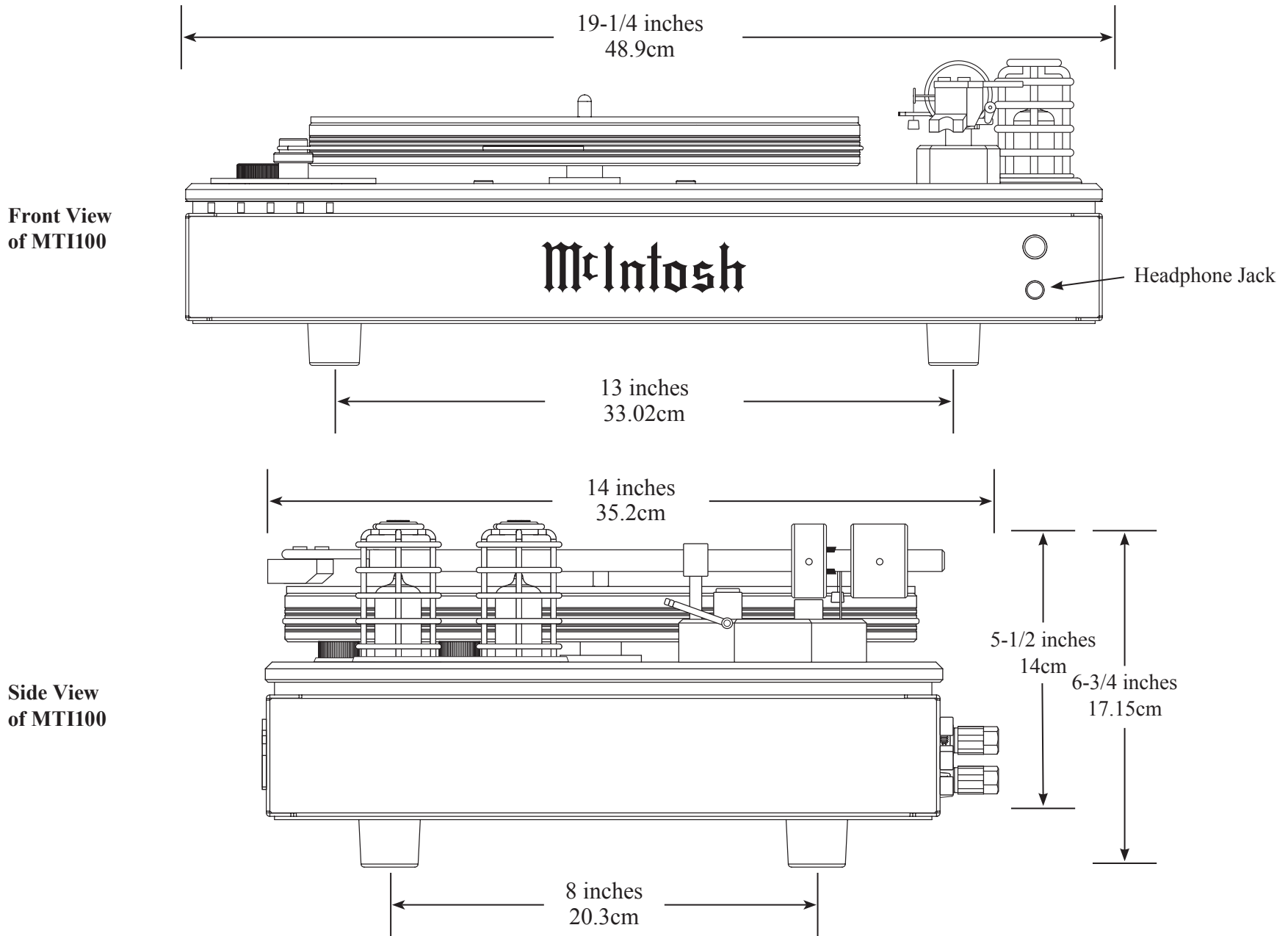

Figure 14– Alignment Jig

Dimensions





Description of Remote Control Buttons

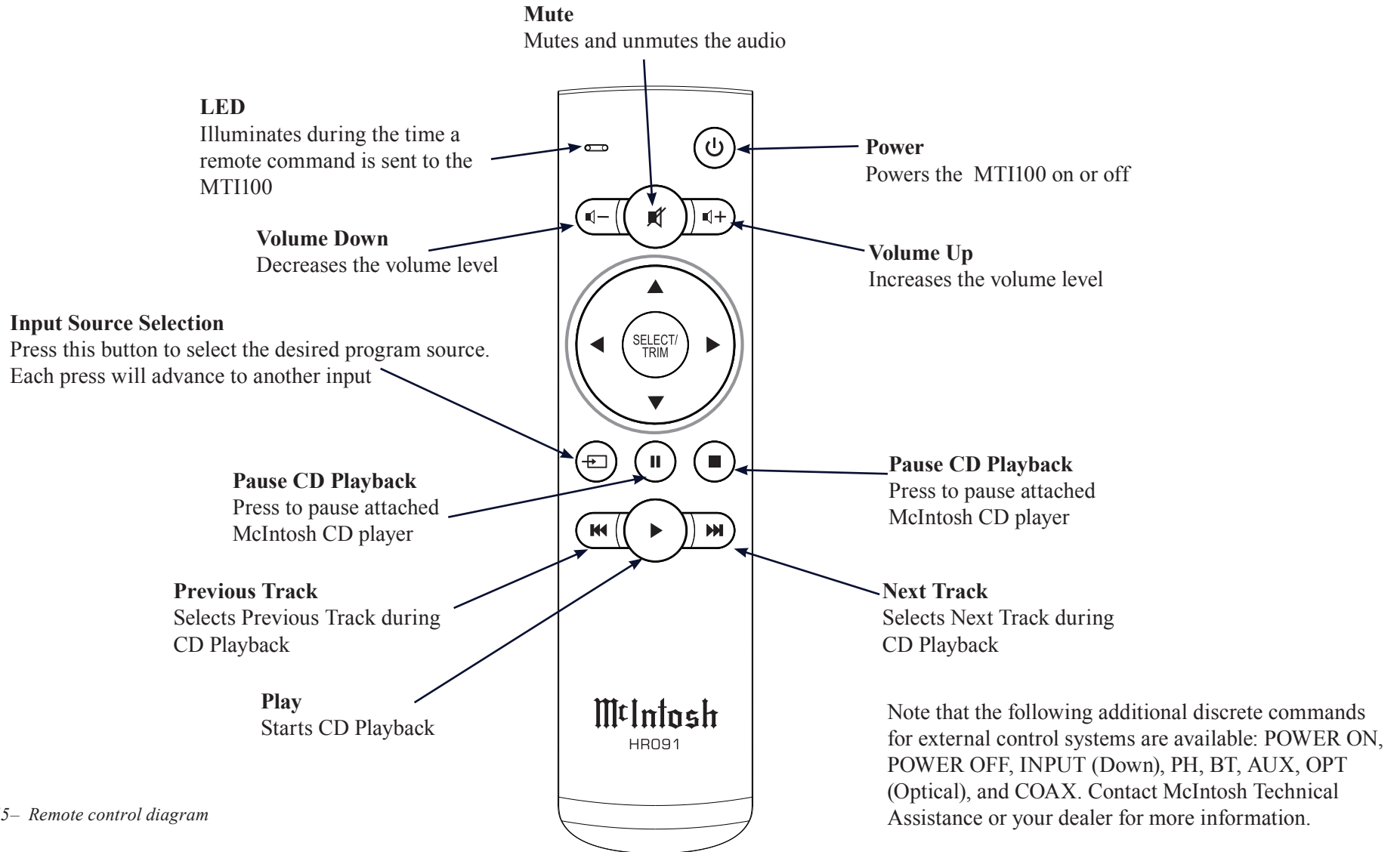

Figure 15– Remote control diagram

Some buttons, like the CD-related buttons or the unlabeled arrow keys, may be used to control other connected McIntosh products.

Changing the Remote's Battery

Someday, the AAA battery in the remote will need to be replaced. This is how to do it.

The back of the remote control is held in place by magnets. To remove the back of the remote to reveal the battery, slide the front of the remote up while sliding the back of the remote down. The goal is to move the back 3/16 of an inch from the top of the remote and then lift it off. There are many ways to do this, as far as positioning your fingers. To open the remote:

- Hold the remote upsidedown and backwards with McIntosh name upsidedown and facing away from you. The thicker end will now be the top and you should be staring at the back of the remote.
- Pinch the remote with your index finger resting on the Trim/Select button and your thumb on the backside (facing you) opposite your index finger's position. Your thumb and remote should both be pointing away from you (see Figure 16).
- Use your thumb to slide the back open 3/16 of an inch. Slide your thumb away from you towards the thicker end of the remote, while your index finger goes in the opposite direction (towards you as if snapping your fingers in slow motion). For added strength, you can use your other hand in a similar position above your first hand using the same technique. Make sure you do not hold the side edge with either hand.

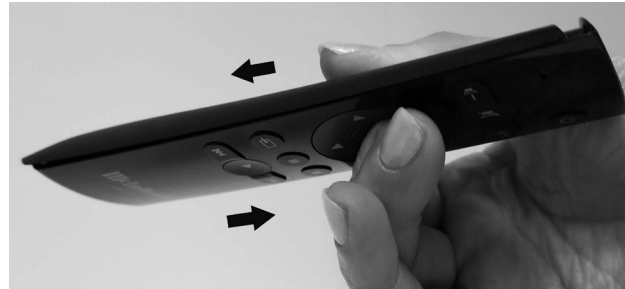

Figure 16– Sliding open the remote

- Lift the back off with your other hand before it snaps closed again. You can grab the now exposed top edge.
- It gets easier after the first time.

Remove and replace the battery noting the polarity (printed below the battery, if you forget).

To replace the back: Place the back in position 3/16 of an inch from the edge. The magnets will help you snap it back into place.

MTI100 Packing Parts List

1	Shipping Carton	03459400
2	Foam Top/Bottom Pad	03459500
1	Foam Accessory Mat	03459600
1	Foam Turntable/Platter	03459700
1	Foam Top Turntable	03459800

Re-packing the MTI100

When shipping the MTI100, it is highly recommended that the unit be packed as it was originally shipped to avoid damage. Failure to properly pack the unit will likely result in damage. If you need any of the packing material, you can contact McIntosh Customer Service.

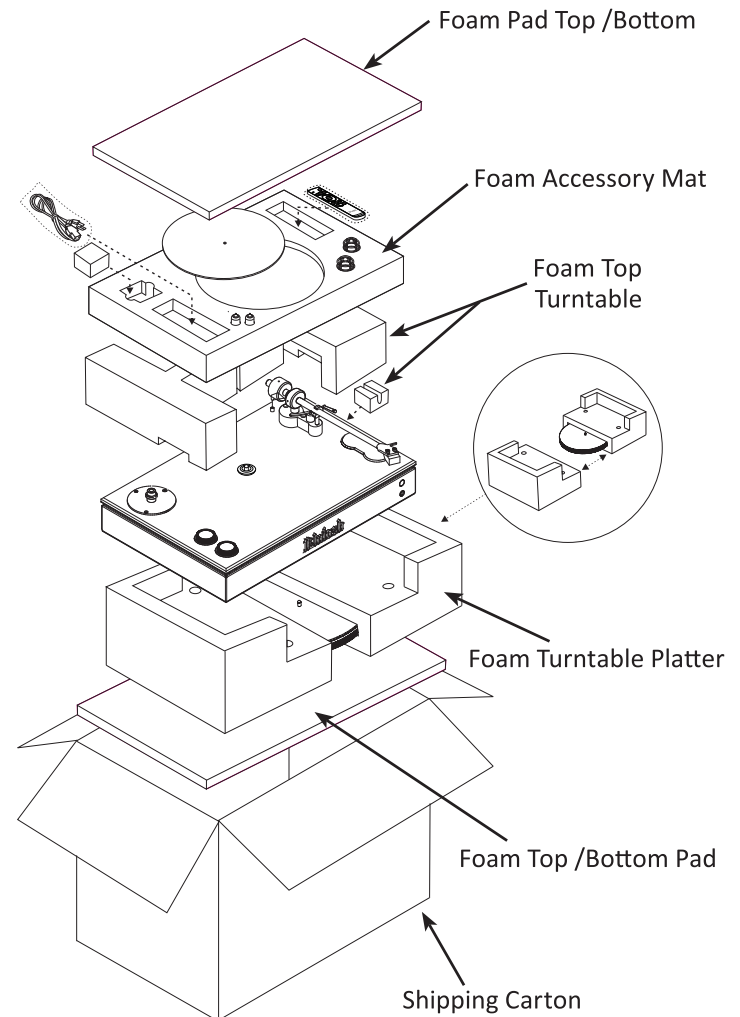



Technical Specifications

Amplifier

Power Output

50 watts into 8 ohm loads

80 watts into 4 ohm loads

Output Load Impedance

8 ohms or 4 ohms

Rated Power Band

20Hz to 20kHz

Total Harmonic Distortion

0.2% maximum harmonic distortion at any level from 250 milliwatts to one-half of rated power output, 20Hz to 20kHz

0.5% maximum harmonic distortion at any level from one-half to full rated power output, 20Hz to 20kHz

Dynamic Headroom

1dB 8 ohm load

1.3dB 4 ohm load

Frequency Response

+0, -0.7dB from 20Hz to 20kHz

Input Sensitivity (for rated output)

1.5V PWR Amplifier IN

A-Weighted Signal to Noise Ratio

93dB (110dB below rated output) PWR Amplifier IN

Intermodulation Distortion

0.1% maximum if instantaneous peak power output does not exceed the rated output for any combination of frequencies from 20Hz to 20kHz

Wide Damping Factor

Greater than 200, 8 ohm load

Greater than 100, 4 ohm load

Input Impedance

6.5K ohms

Voltage gain

22dB

Preamplifier

Frequency Response

+0, -0.7dB from 20Hz to 20,000Hz

Total Harmonic Distortion

0.2% from 20Hz to 20,000Hz

Rated Output (Main)

1.5V

Maximum Voltage Output

9V RMS

Sensitivity (for rated output)

High Level, 300mV AUX Input

Signal To Noise Ratio (A-Weighted)

High Level, 90dB

Phono, 75dB

Input Impedance

68K ohms AUX Input

Maximum Input Signal

4V AUX Input

Phono MM, 45mV

Voltage Gain

AUX Input to Main Output: 14dB

Phono MM Section: 40dB

Output Impedance

100 ohms

Headphone Load Impedance

100 ohms to 600 ohms

Digital Input Sample Rates

Optical: 16Bit, 24Bit - 32kHz to 192kHz

Coaxial: 16Bit, 24Bit - 32kHz to 192kHz

Bluetooth Profiles

A2DP, AVRCP, SBC, HD

TRIGGER OUTPUT

12VDC, 50mA maximum

Olympia Cartridge

Cartridge Type Moving Magnet (MM)

Frequency Response 12Hz-30kHz

Output Voltage/Channel 4mV @ 1kHz

Channel Separation 30dB @ 1kHz

Channel Balance 1.5dB/1kHz

Compliance 12x10⁻⁶ cm/dyn @ 100Hz

Stylus Size/Shape .3x.7/Elliptical

Load Impedance 47k Ohms

Tracking Force Range 1.8-2.2 grams

Recommended Force 2.0 grams

Cartridge Weight 6.5 grams

Tone Arm

Tone Arm Specifications:

Cardan bearing arrangement with ball bearings used for lateral and Sapphire/Tungsten for vertical bearing

Machined aluminum tube arm

Pivot to spindle 223mm

Effective length 240.7mm

Overhang 17.7mm

Offset angle 22.85°

Average RMS distortion 0.36%

The Table

3/8-inch Thick Glass anchored to custom 1/4-inch thick aluminum metal plate for stability

Aluminum Alloy Platter

Platter Specifications:

Weight: 7.5lbs (3.4Kg)

Material: Aluminum alloy

Bearing Specifications:

Inverted hardened steel shaft and axial ball arrangement with bronze bushing

Motor

600 RPM Direct Drive Permanent Magnet AC Synchronous Motor AC - 2 speed pulley

Turntable Speeds

33 $\frac{1}{3}$ RPM and 45 RPM

General

Power Requirements

Refer to the rear panel of the MTI100 for the correct voltage

The MTI100 is factory configured for one of the following AC Voltages

100 Volts, 50/60Hz at 50 watts

110 Volts, 50/60Hz at 50 watts

120 Volts, 50/60Hz at 50 watts

220 Volts, 50/60Hz at 50 watts

230 Volts, 50/60Hz at 50 watts

240 Volts, 50/60Hz at 50 watts

Standby Power, less than 0.5 watts

Field AC Voltage conversion of the MTI100 is not possible

Dimensions

Width 19-1/4 inches (48.9cm)

Height 6-3/4 inches (17.15cm) including feet

Depth 14 inches (35.6cm) including antenna

Weight

33.5 pounds (15.2 kg) net

40.5 pounds (18.4 kg) in shipping carton

Shipping Carton Dimensions

Width 24 inches (68.6cm)

Height is 16-1/2 inches (35.6cm)

Depth is 17-1/2 inches (63.5cm)

Trademark and License Information

The McIntosh MTI100 incorporates copyright protected technology that is protected by U.S. patents and other intellectual property rights. The MTI100 uses the following technologies:

Trademark Logo	License Information
 Bluetooth®	The Bluetooth® word mark and logos are registered trademarks owned by Bluetooth SIG, Inc. and any use of such marks by McIntosh Group, Inc. is under license. Other trademarks and trade names are those of their respective owners.



McIntosh Laboratory, Inc.
2 Chambers Street
Binghamton, NY 13903
www.mcintoshlabs.com

The continuous improvement of its products is the policy of McIntosh Laboratory Incorporated who reserve the right to improve design without notice.

Printed in the U.S.A.