



McIntosh Laboratory, Inc. 2 Chambers Street Binghamton, New York 13903-2699 Phone: 607-723-3512 www.mcintoshlabs.com

MA7900
Integrated Amplifier
Owner's Manual



The lightning flash with arrowhead, within an equilateral triangle, is intended to alert the user to the presence of uninsulated “dangerous voltage” within the product’s enclosure that may be of sufficient magnitude to constitute a risk of electric shock to persons.

WARNING - TO REDUCE RISK OF FIRE OR ELECTRICAL SHOCK, DO NOT EXPOSE THIS EQUIPMENT TO RAIN OR MOISTURE.



AVIS RISQUE DE CHOC ELECTRIQUE - NE PAS OUVRIR.

NO USER-SERVICEABLE PARTS INSIDE. REFER SERVICING TO QUALIFIED PERSONNEL.

The exclamation point within an equilateral triangle is intended to alert the user to the presence of important operating and maintenance (servicing) instructions in the literature accompanying the appliance.

To prevent the risk of electric shock, do not remove cover or back. No user-serviceable parts inside.

IMPORTANT SAFETY INSTRUCTIONS!

PLEASE READ THEM BEFORE OPERATING THIS EQUIPMENT.

1. Read these instructions.
2. Keep these instructions.
3. Heed all warnings.
4. Follow all instructions.
5. Do not use this apparatus near water.
6. Clean only with a dry cloth.
7. Do not block any ventilation openings. Install in accordance with the manufacturer’s instructions.
8. Do not install near any heat sources such as radiators, heat registers, stoves, or other apparatus (including amplifiers) that produce heat.
9. Do not defeat the safety purpose of the polarized or grounding-type plug. A polarized plug has two blades with one wider than the other. A grounding type plug has two blades and a

third grounding prong. The wide blade or the third prong are provided for your safety. If the provided plug does not fit into your outlet, consult an electrician for replacement of the obsolete outlet.

10. Protect the power cord from being walked on or pinched particularly at plugs, convenience receptacles, and the point where they exit from the apparatus.
11. Only use attachments/accessories specified by the manufacturer.
12. Use only with the cart, stand, tripod, bracket, or table specified by the manufacturer, or sold with the apparatus. When a cart is used, use caution when moving the cart/apparatus combination to avoid injury from tip-over.
13. Unplug this apparatus during lightning storms or when unused for long periods of time.
14. Refer all servicing to qualified service personnel. Servicing is required when the apparatus has been damaged in any way, such as power-



supply cord or plug is damaged, liquid has been spilled or objects have fallen into the apparatus, the apparatus has been exposed to rain or moisture, does not operate normally, or has been dropped.

15. Do not expose this equipment to dripping or splashing and ensure that no objects filled with liquids, such as vases, are placed on the equipment.
16. To completely disconnect this equipment from the a.c. mains, disconnect the power supply cord plug from the a.c. receptacle.
17. The mains plug of the power supply cord shall remain readily operable.
18. Do not expose batteries to excessive heat such as sunshine, fire or the like.
19. Connect mains power supply cord only to a mains socket outlet with a protective earthing connection.

Thank You

Your decision to own this McIntosh MA7900 Integrated Amplifier ranks you at the very top among discriminating music listeners. You now have the best. The McIntosh dedication to precision performance assures many years of musical enjoyment. Please take a short time to read the information in this manual. We want you to be as familiar as possible with all the features and functions of your new McIntosh.

Please Take A Moment

The serial number, purchase date and McIntosh Dealer name are important to you for possible insurance claim or future service. The spaces below have been provided for you to record that information:

Serial Number: _____

Purchase Date: _____

Dealer Name: _____

Technical Assistance

If at any time you have questions about your McIntosh product, contact your McIntosh Dealer who is familiar with your McIntosh equipment and any other brands that may be part of your system. If you or your Dealer wish additional help concerning a suspected problem, you can receive technical assistance for all McIntosh products at:

McIntosh Laboratory, Inc.
2 Chambers Street
Binghamton, New York 13903
Phone: 607-723-3512
Fax: 607-724-0549

Customer Service

If it is determined that your McIntosh product is in need of repair, you can return it to your Dealer. You can also return it to the McIntosh Laboratory Service Department. For assistance on factory repair return procedure, contact the McIntosh Service Department at:

McIntosh Laboratory, Inc.
2 Chambers Street
Binghamton, New York 13903
Phone: 607-723-3515
Fax: 607-723-1917

Table of Contents

Safety Instructions.....	2-3
Thank You and Please Take a Moment	3
Technical Assistance and Customer Service.....	3
Table of Contents	3
General Information	4
Connector and Cable Information.....	4
Introduction	5
Performance Features	5
Dimensions	6
Installation	7
Connections:	
Rear Panel Connections.....	8
(Separate Sheet)	Mc1A
Connecting Components	9
Connection Diagrams (Separate Sheet).....	Mc2A/2B
Passthru Connections	10
Connecting for Bi-Amplification	11
Connecting Loudspeakers	12-13
Remote Control and Front Panel:	
Remote Control Push-buttons	14
How to use the Remote Control.....	15
Front Panel Displays, Controls, Push-buttons and Jack	16

Setup Mode:

How to Operate the Setup Mode	17
Default Settings	17
Firmware Version	18
Source Input Reassignment	18
Source Input Renaming.....	19
Passthru	20
Power Control Triggers 1 and 2.....	20
Comm Port Baud Rate.....	21
Remote Control Codes	22
Power Mode.....	22

Operation:

How to Operate the MA7900	24
Power On/Off	24
Source Selection	24
Volume Control	24

Trim Functions:

Balance.....	24
Equalizer Mode.....	25
Trim Level.....	25
Mono/Stereo Mode and Phono Adjustments	26
Display Brightness.....	26
Digital Audio Display	27
Meter Backlight	27
Equalizer Bypass, Trim, Mute	27
Headphone Jack	27
Power Output Meters.....	28
Power Guard and How to Make a Recording.....	28
Using a Separate Power Amplifier.....	28
Using Output 2	28
Passthru and Equalizer Controls.....	29
Optical and Coaxial Digital Inputs	30
USB Input Operation with a Computer.....	30
Reset of Microprocessors	30
Resetting the MA7900 to default settings.....	30
Photos.....	31-32
Specifications.....	33-34
Packing Instructions	35

General Information

1. For additional connection information, refer to the owner's manual(s) for any component(s) connected to the MA7900.
2. Apply AC Power to the MA7900 and other McIntosh Component(s) only after all the system components are connected together. Failure to do so may cause a malfunction of system operations as the Microprocessor's Circuitry inside the components is active when AC Power is applied.
3. **The MA7900 includes an Auto Off Power Save Feature and the default setting is enabled.** For additional information including how to disable it, refer to page 22.
4. When Power Amplifier Protection Circuitry of the MA7900 has activated, the Front Panel Power Guard LEDs are illuminated continuously and the sound will be muted.
5. When the Power Transformer has overheated due to improper ventilation and/or high ambient operating temperature, AC Power is removed from the MA7900. Normal operation will resume when the operating temperature is in a safe range again.
6. For the best performance and safety, it is important to always match the impedance of the Loudspeaker to the Power Amplifier connections. Refer to pages 14 thru 16.

Note: The impedance of a Loudspeaker actually varies as the Loudspeaker reproduces different frequencies. As a result, the nominal impedance rating of the Loudspeaker (usually measured at a midrange frequency) might not always agree with the impedance of the Loudspeaker at low frequencies where the greatest amount of power is required. Contact the Loudspeaker Manufacturer for additional information about the actual impedance of the Loudspeaker before connecting it to the McIntosh MA7900.

7. The MA7900 Remote Control is capable of operating other components. For additional information go to www.mcintoshlabs.com.
8. The IR Input, with a 1/8 inch mini phone jack, is configured for non-McIntosh IR sensors such as a Xantech Model HL85BK Kit. Use a Connection Block such as a Xantech Model ZC21 when two or more IR sensors need to be connected to the MA7900. The signal from a connected External IR Sensor will have priority over the signal from the Front Panel IR Sensor.
9. When discarding the unit, comply with local rules or regulations. Batteries should never be thrown away or incinerated but disposed of in accordance with the local regulations concerning battery disposal. 
10. For additional information on the MA7900 and other McIntosh Products please visit the McIntosh Web Site at www.mcintoshlabs.com.

Connector and Cable Information

XLR Connectors

Below is the Pin configuration for the XLR Balanced Input Connectors on the MA7900. Refer to the diagram for connection:

- PIN 1: Shield/Ground
- PIN 2: + Output
- PIN 3: - Output

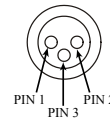

Power Control and Trigger Connectors

The Power Control Trigger Output Jacks send and Passthru Input Jack receives Power On/Off Signals (+12 volt/0 volt) when connected to other McIntosh Components. An additional connection is for controlling the illumination of the Power Output Meters

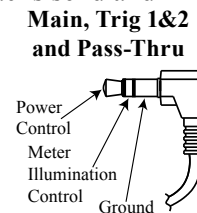

on McIntosh Power Amplifiers. A 3.5mm stereo mini phone plug is used for connection to the Power Control, Trigger and Passthru Outputs.

Data Port Connectors

The Data Out Ports send Remote Control Signals to Source Components. A 3.5mm stereo mini phone plug is used for connection.

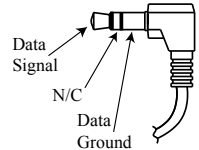

IR IN Port Connectors

The IR IN Port also uses a 3.5mm stereo mini phone plug and allows the connection of other brand IR Receivers to the MA7900.

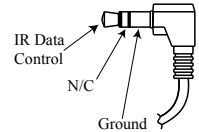

RS232-C Data Port Cable

The RS232 Data Cable is a 3.5mm stereo mini phone plug to a sub miniature DB 9 connector:

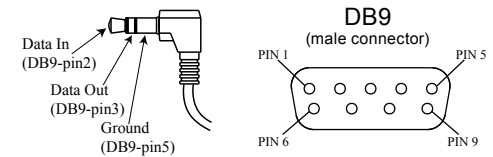

McIntosh Plug-In Jumper Connector

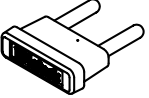
The MA7900 utilizes a phono style Plug-In Jumper to connect the Preamplifier Output to the Power Amplifier Input, one Jumper for each channel. 

Note: The Jumper Connector is available from the McIntosh Parts Department:

McIntosh Jumper Connector Part No. 117781

Introduction

Now you can take advantage of traditional McIntosh standards of excellence in the MA7900 Integrated Amplifier. The Power Amplifier section of the MA7900, with a power output of 200 watts per channel, will drive a pair of quality Loudspeakers to a high level of performance.

The flexible Preamplifier section provides connections for various input sources and may also be used to drive an external Power Amplifier(s).

The MA7900 reproduction is sonically transparent and absolutely accurate. The McIntosh Sound is “The Sound of the Music Itself.”

Performance Features

• Power Output with Patented Autoformer

The MA7900 consists of a 200 watts per channel stereo Power Amplifier with less than 0.005% distortion. The McIntosh designed and manufactured Autoformer allows connection of 2, 4 or 8 ohm Loudspeakers. The Power Amplifier uses ThermalTrak¹ Output Transistors for lower distortion and cool operation.

• Power Guard

The patented McIntosh Power Guard circuit prevents amplifier clipping and protects your valuable Loudspeakers.

• Sentry Monitor and Thermal Protection

McIntosh Sentry Monitor power output stage protection circuits ensure the MA7900 will have a long and trouble free operating life. Built-in Thermal Protection Circuits guard against overheating.

• Electronic Switching and Balanced Connections

The Preamplifier uses Logic Circuits controlling

Electromagnetic Switches on all inputs and operating functions for reliable, noiseless, distortion free switching. There is a Balanced Input for connection of a source component.

• Digital Audio Inputs

The MA7900 has Coaxial, Optical and USB Digital Inputs to decode PCM Signals from an external source. The MA7900 Up Samples the Digital Signal to 192kHz with 32Bit resolution before the Digital to Analog process begins.

• Moving Coil and Moving Magnet Phono Inputs

The MA7900 contains two different precision Phono Preamplifier Circuits. One for low output Moving Coil Phono Cartridges with selectable resistance loading, the other is for Moving Magnet Cartridges. Both circuits use the latest designs to provide the lowest possible noise and distortion. The RIAA Correction Circuitry utilizes close tolerance resistors and capacitors for an extremely flat frequency response.

• Five Band Equalizer

The Equalizer Controls provide 12dB of boost or cut at center frequencies of 30, 125, 500, 2,000 and 10,000Hz. There is also an Equalizer Bypass Mode to remove the Equalizer from the Signal Path of any selected input.

• Multifunction Fluorescent Display

The Front Panel Display indicates source selection, volume levels and setup functions.

• Illuminated Power Meters

The Illuminated Power Output Watt Meters on the MA7900 are peak responding, and indicate the power output of the amplifier.

• PassThru Mode

The Automatic PassThru Mode allows the MA7900 to become part of a Multichannel Sound System for DVD-Audio, SACD and Home Theater Movies.

• Power Control and Remote Control

The Power Control Output connection provides convenient Turn-On/Off of McIntosh Source Components. The Data Ports together with the supplied Remote Control provide control of McIntosh Source Components connected to the MA7900.

• Special Power Supply

The large Power Transformer, multiple filter capacitors with 120 Joules of Energy Storage and regulated Power Supply ensures stable noise free operation even though the power line varies.

• McIntosh Custom Binding Posts

McIntosh Patented gold plated output terminals deliver high current output. They accept large diameter wire and spade lugs. Banana plugs may also be used only in the United States and Canada.

• Fiber Optic Solid State Front Panel Illumination

The even Illumination of the Front Panel is accomplished by the combination of custom designed Fiber Optic Light Diffusers and extra long life Light Emitting Diodes (LEDs).

• Glass Front Panel and Super Mirror Chassis Finish

The famous McIntosh Illuminated Glass Front Panel and the Stainless Steel Chassis with Super Mirror Finish ensures the pristine beauty of the MA7900 will be retained for many years.

¹ ThermalTrak™ and ON Semiconductor are trademarks of Semiconductor Components Industries, LLC

Dimensions

The following dimensions can assist in determining the best location for your MA7900. There is additional information on the next page pertaining to installing the MA7900 into cabinets.

Front View of the MA7900

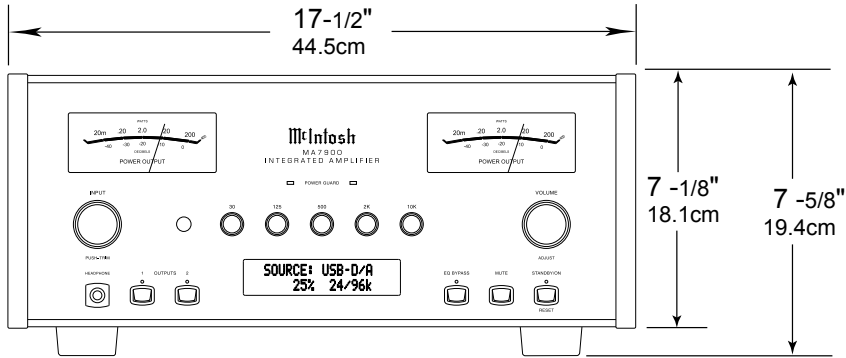

Rear View of the MA7900

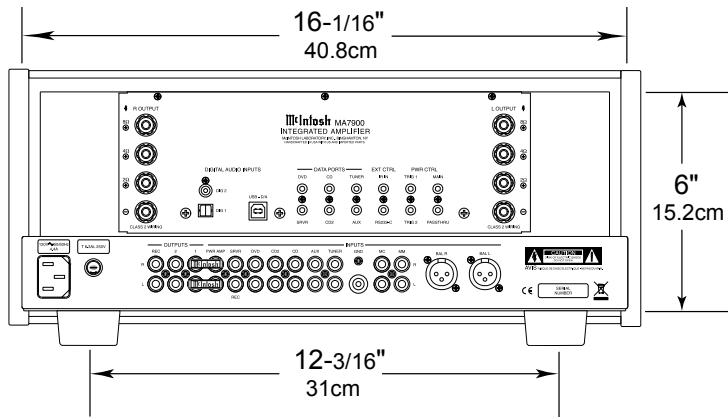

Side View of the MA7900

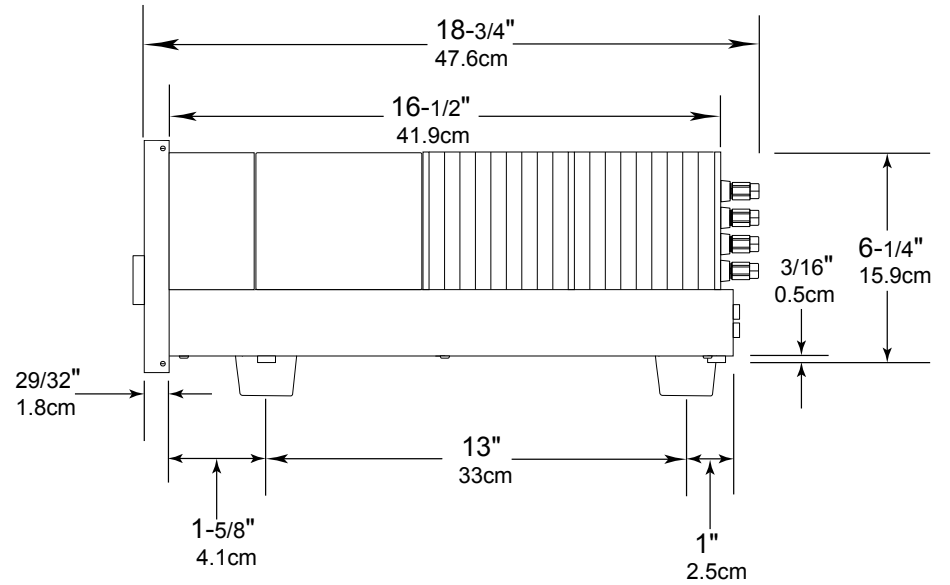

Installation

The MA7900 can be placed upright on a table or shelf, standing on its four feet. It also can be custom installed in a piece of furniture or cabinet of your choice. The four feet may be removed from the bottom of the MA7900 when it is custom installed as outlined below. The four feet together with the mounting screws should be retained for possible future use if the MA7900 is removed from the custom installation and used free standing. The required panel cutout, ventilation cutout and unit dimensions are shown.

Always provide adequate ventilation for your MA7900. Cool operation ensures the longest possible operating life for any electronic instrument. Do not install the MA7900 directly above a heat generating component such as a high powered amplifier. If all the components are installed in a single cabinet, a quiet running ventilation fan can be a definite asset in maintaining all the system components at the coolest possible operating temperature.

A custom cabinet installation should provide the following minimum spacing dimensions for cool operation.

Allow at least 6 inches (15.24cm) above the top, 2 inches (5.08cm) below the bottom and 2 inches (5.1cm) on each side of the Integrated Amplifier, so that air-flow is not obstructed. Allow 20 inches (50.8cm) depth behind the front panel. Allow 1-7/6 inch (3.66cm) in front of the mounting panel for knob clearance. Be sure to cut out a ventilation hole in the mounting shelf according to the dimensions in the drawing.

**MA7900 Front Panel
Custom Cabinet Cutout**

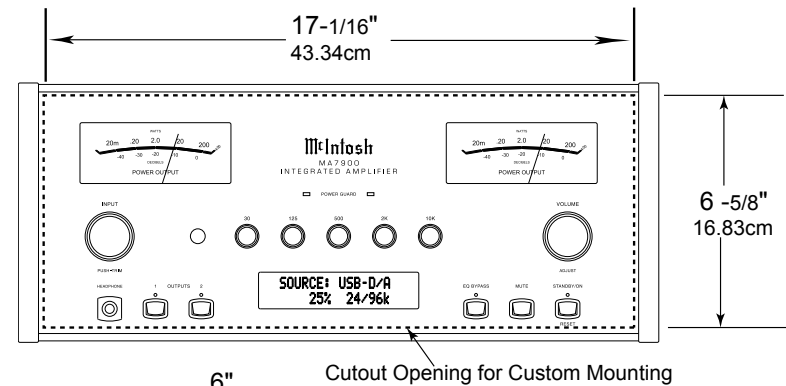

**MA7900 Side View
in Custom Cabinet**

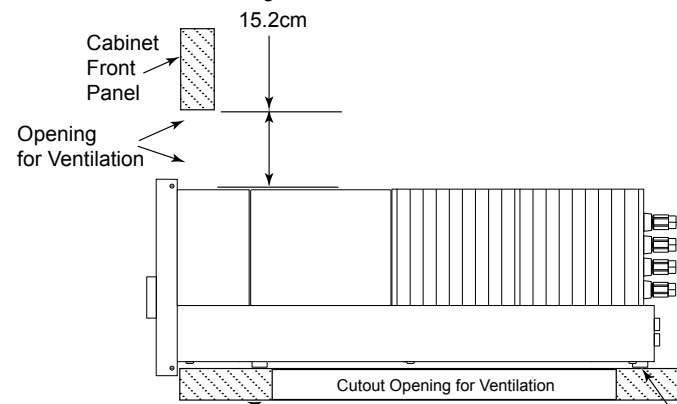

**MA7900 Bottom View
in Custom Cabinet**

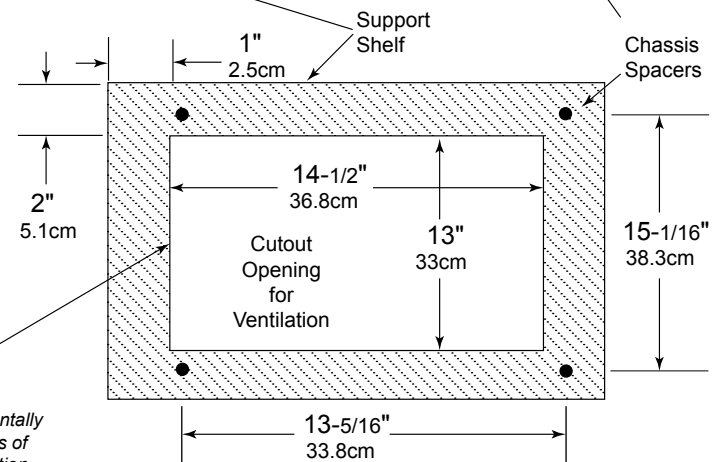

Note: Center the cutout Horizontally on the unit. For purposes of clarity, the above illustration is not drawn to scale.

Rear Panel Connections

The identification of Rear Panel Connections for the MA7900 Integrated Amplifier is located on a separate folded sheet contained in the Owner's Manual Packet. Refer to separate sheet "McIA" for the Rear Panel Connections.

MA7900 Integrated Amplifier

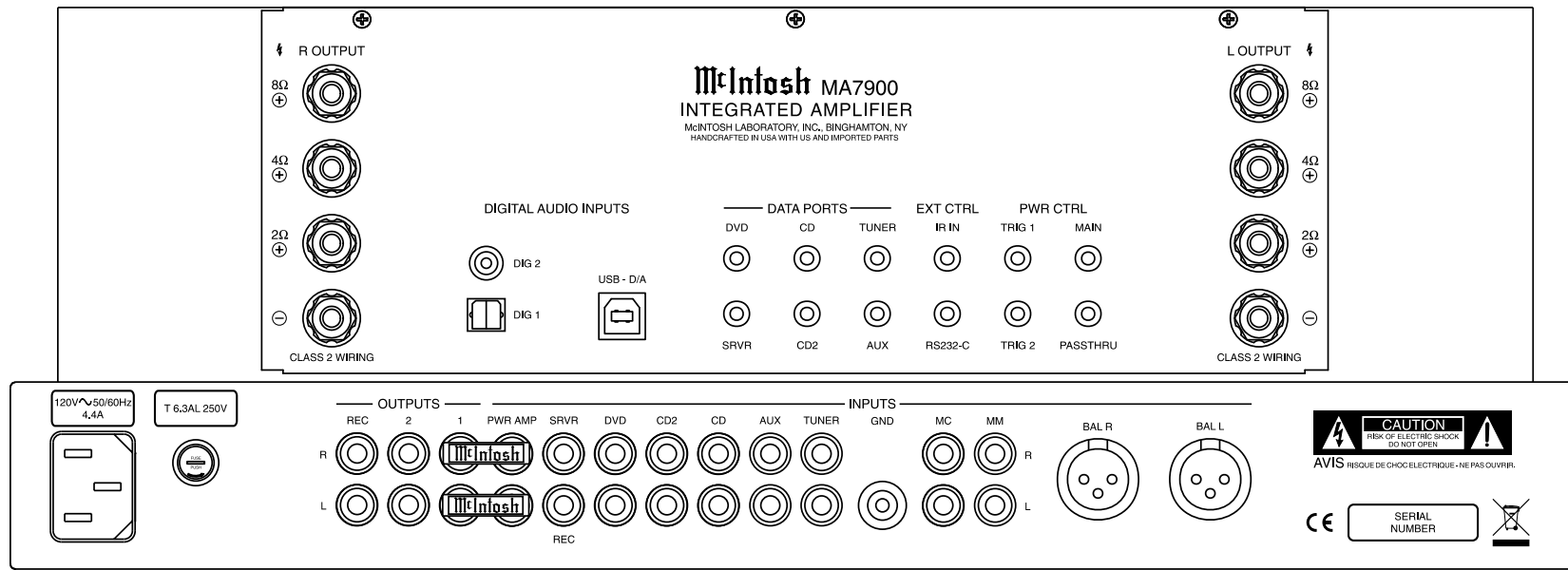

Connecting Components

The MA7900 has the ability to automatically switch power On/Off to McIntosh Source Components via the Power Control (Trigger) connections. The Data Port Connections allow for the remote operation of basic functions using the MA7900 Remote Control. With an external sensor connected to the MA7900, remote control operation of the system is possible from another room and/or when the MA7900 is located in a cabinet with the doors closed.

The connection instructions below, together with the MA7900 Input and Output Connection Diagrams located on the separate folded sheet “**Mc2A/2B**”, are an example of a typical audio system. Your system may vary from this, however the actual components would be connected in a similar manner. For additional information refer to “Connector and Cable Information” on page 5.

Note: Source components may be connected to the MA7900 Balanced Inputs or Digital Inputs instead of Unbalanced Inputs. Refer to Setup “Re-assigning Inputs” to activate them on page 18.

Power Control Connections:

1. Connect a Control Cable from the MA7900 PWR CTRL (Power Control) MAIN Jack to the Power Control In on the Turntable.
2. Connect a Control Cable from the McIntosh Turntable Power Control Out Jack to the Audio/Video Player Power Control In Jack.
3. Connect a Control Cable from the Audio/Video Player Power Control Out Jack to the AM/FM Tuner Power Control In Jack.
4. Connect a Control Cable from the AM/FM Tuner Power Control Out Jack to the SACD/CD Player Power Control In Jack.
5. Optionally connect a Control Cable from the MA7900 PWR CTRL (Power Control) TRIG

(Trigger) 2 Jack to the Power Amplifier (Secondary Room) Power Control In Jack.

Note: The default setting for the TRIG 2 Jack is “MAIN”. Refer to Setup “Power Control Triggers 1 and 2” on page 20 to change TRIG 2 setting to “OUTPUT 2”.

6. Connect any additional McIntosh Components in a similar manner, as outlined in steps 1 thru 4.

Data Control Connections:

7. Connect a Control Cable from the MA7900 CD DATA PORT Jack to the SACD/CD Player Data In Jack.
8. Connect a Control Cable from the MA7900 TUNER DATA PORT Jack to the AM/FM Tuner Data In Jack.
9. Connect a Control Cable from the MA7900 DVD DATA PORT Jack to the Audio/Video Player Data In Jack.
10. Connect any additional McIntosh Components in a similar manner, as outlined in steps 7 thru 9.

Sensor Connection:

11. Optionally, connect the cable with stereo mini plug coming from the compatible External Sensor to the EXT CTRL (External Control) IR IN Jack on the MA7900. Refer to page 4 “General Information, note 8” for additional information.

Audio Connections:

12. Connect Balanced Cables from the MA7900 BAL (Balanced) L & R Connectors to the SACD/CD Player Fixed Audio Output Balanced Connectors.
13. Connect Audio Cables from the MA7900 TUNER INPUT Jacks to the AM/FM Tuner Output Jacks.
14. Connect Audio Cables from the MA7900 DVD INPUT Jacks to the Audio/Video Player Output Jacks.

15. Connect the Audio Cables coming from the Turntable to the MA7900 MC (for a Moving Coil Cartridge) or MM (for a Moving Magnet Cartridge) INPUT Jacks.
16. Optionally, connect Audio Cables from the MA7900 OUTPUT 2 Jacks to the Power Amplifier (Secondary) Input Jacks.
17. Connect any additional Components in a similar manner, as outlined in steps 11 thru 14.

Optional Digital Audio Connections:

18. Connect a Coaxial Cable from the MA7900 DIG (Digital) 1 Digital Audio Input Jack to the Digital Out Coaxial Jack on the Audio/Video Player.
19. Connect an Optical Cable from the MA7900 DIG (Digital) 2 Digital Audio Input connector to the Digital Audio Out Optical Connector on the SACD/CD Player.

Optional USB Connection:

20. Connect a USB cable with (type A to type B) connectors from the MA7900 USB D/A Digital Audio Input to an available USB connector.

Ground Connections:

21. Connect the Ground Cable coming from the Turntable to the MA7900 GND Binding Post.

Notes: 1. If the MA7900 is part of a Home Theater System, proceed to “PassThru” connection on page 10.

2. When the MA7900 will used together with a separate Power Amplifier for Bi-Amplification of a Loudspeaker System, proceed page 11.

Passthru Connections

The MA7900 can be part of a Multichannel Sound System for SACD, DVD-Audio and Home Theater. The Right and Left Front Channels from an Audio/Video Control Center can “Passthru” the MA7900. In the following example the SRVR Input will become the “Passthru” input:

1. Connect Audio Cables from the A/V Control Center Front Left and Right Channel Outputs to the MA7900 SRVR Input Left and Right Jacks.
 2. Connect a Control Cable from the A/V Control Center ZA (Zone A) PC (Power Control) Output to the MA7900 PWR CTRL (Power Control) PASSTHRU Input Jack.
- Note: Refer to Setup “Passthru” on page 20 to assign the SRVR Input as the “Passthru” Input.*
3. Proceed to “Connecting Loudspeaker” on Page 12.

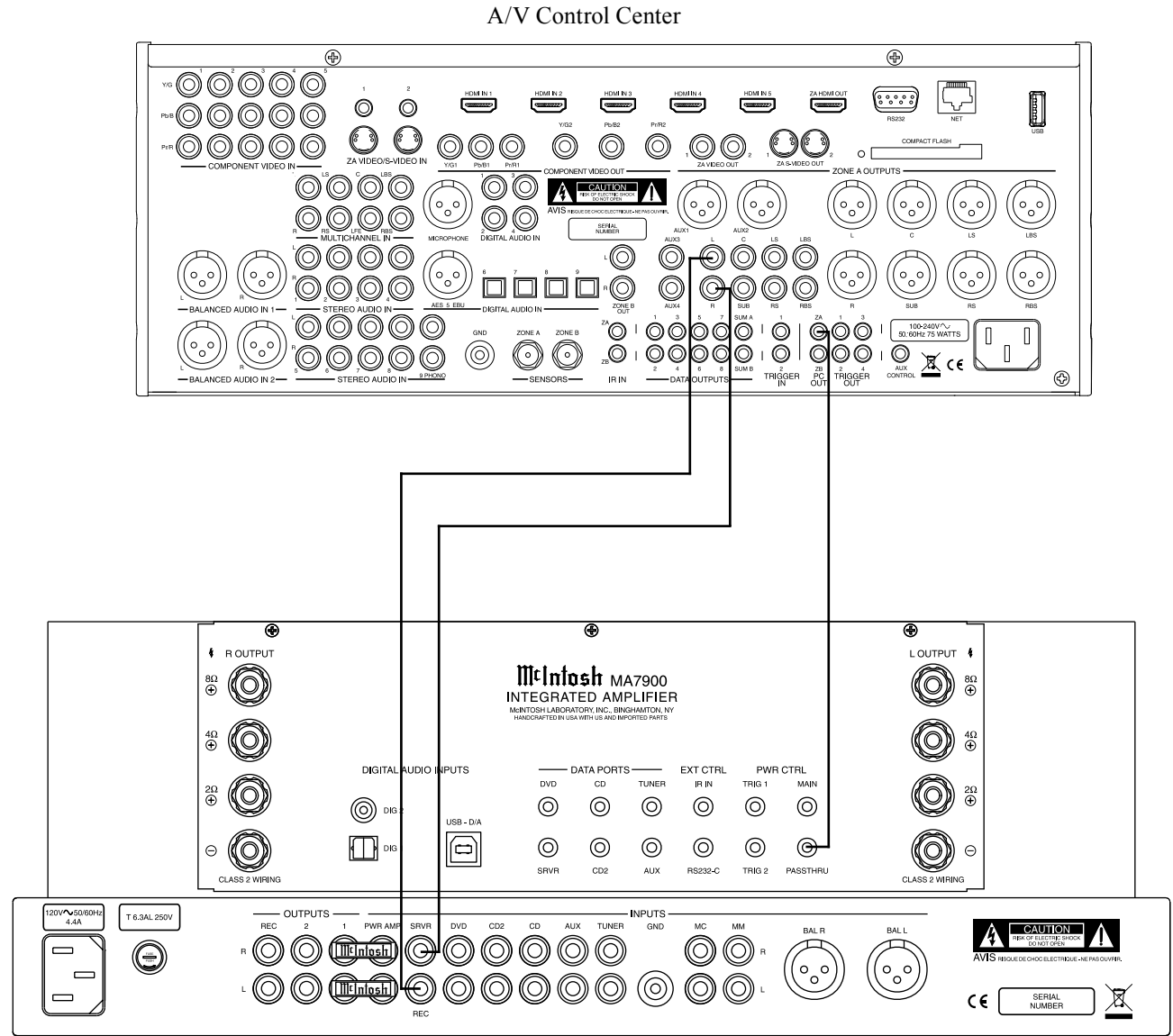

Connecting for Bi-Amplification

The MA7900's Power Amplifier, together with an additional separate Power Amplifier, may be used to Bi-Amplify a Loudspeaker System. In the illustration on this page the Power Amplifier of the MA7900 is connected to the Midrange/High Frequency Section of the Loudspeaker. The additional separate Power Amplifier is connected to the Low Frequency Section of the Loudspeaker System.

Warning: *The Loudspeaker System used for Bi-Amplification must have the jumpers removed from between the MID/HIGH and LOW Frequency Sections of the Loudspeaker System. Failure to remove them could result in damage to the MA7900 and/or the separate Power Amplifier.*

MA7900 Connections:

1. Remove the "McIntosh Jumpers" from between the OUTPUT 1 Jacks and the PWR AMP In Jacks located on the Rear Panel of the MA7900.

Note: Place the "McIntosh Jumper" in a safe place for possible future use.

2. Using a pair of shielded RCA Type Audio "Y" Adapters connect the OUTPUT 1 Jacks to the PWR AMP In Jacks, for both Left and Right Channels.
3. Connect the remaining unconnected part of the "Y" Adapters to the separate Power Amplifier.
4. Referring to the Loudspeaker Connection Instructions on page 12, and in the Owner's Manual supplied with the Power Amplifier and Loudspeaker, connect the MA7900 Output Terminals to the Loudspeaker MID/HIGH Input Terminals.

Note: The Loudspeaker Connection illustrations on this page are for the Left Channel. Connect the Right Channel Loudspeaker in the same manner.

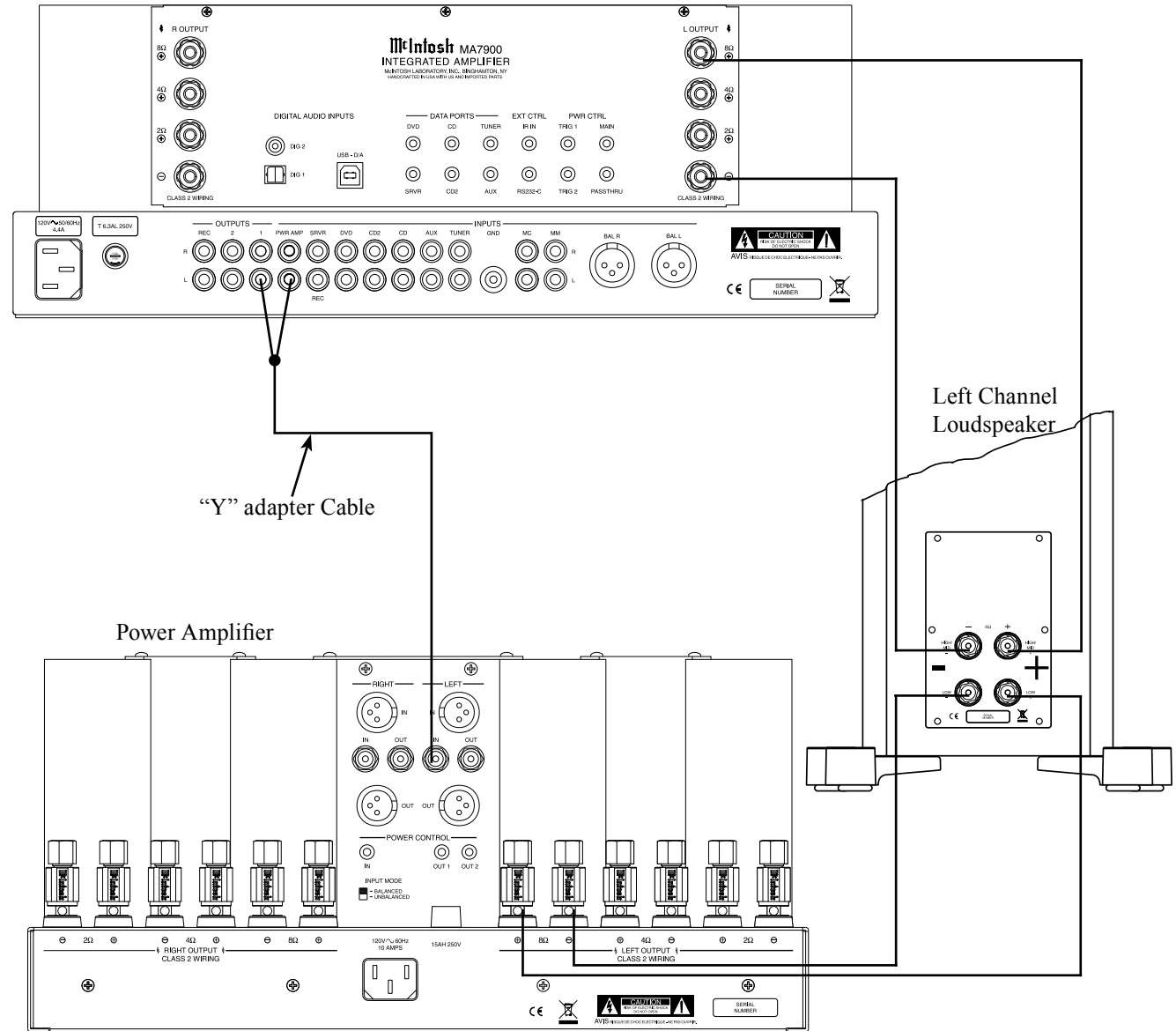

Output Terminals

When connecting the Loudspeaker Hookup Cables to the MA7900 Amplifier Output Terminals please follow the steps below:

1. Rotate the top of the Output Terminal Post counterclockwise until an opening appears. Refer to figures A and B.
2. Insert the Loudspeaker hookup cable into the Output Terminal Post opening or the cable spade lug around the center post of the Output Terminal. Refer to figure C.
3. Rotate the top of the Output Terminal Post clockwise until it is finger tight. Refer to figure D.
4. Place the supplied McIntosh Wrench over the top of the Output Terminal and rotate it one quarter of a turn (90°) to secure the Loudspeaker Cable Connection. **Do not over tighten.** Refer to figure E.

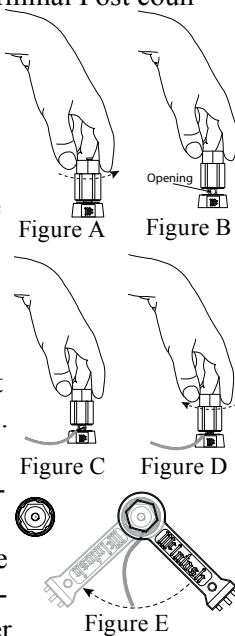

How to Connect Loudspeakers

Caution: Do not connect the AC Power Cord to the MA7900 Rear Panel until after the Loudspeaker Connections are made. Failure to observe this could result in Electric Shock.

The connection instructions below, together with the MA7900 Connection Diagram located on the separate folded sheet “Mc2B”, is an example of a typical audio system. Your system may vary from this, however the actual components would be connected in a similar manner. For additional information refer to “Connector and Cable Information” on page 4.

The McIntosh MA7900 Power Amplifier Circuitry is designed for Loudspeakers with an impedance of 2 ohms, 4 ohms or 8 ohms. Connect a single Loudspeaker only to the Right and Left Output Terminals.

When connecting Loudspeakers to the MA7900 it is very important to use cables of adequate size, so there is little to no power loss in the cables. The size is specified in Gauge Numbers or AWG (American Wire Gauge). The smaller the Gauge number, the larger the wire size:

Loudspeaker Cable Distance vs Wire Gauge Guide			
Loudspeaker Impedance	25 feet (7.62 meters) or less	50 feet (15.24 meters) or less	100 feet (30.48 meters) or less
2 Ohms	12AWG	10AWG	8AWG
4 Ohms	14AWG	12AWG	10AWG
8 Ohms	16AWG	14AWG	12AWG

1. Prepare the Loudspeaker Hookup Cable for attachment to the MA7900 Power Amplifier:

Bare wire cable ends:

Carefully remove sufficient insulation from the cable ends, refer to figures F, G & H. If the cable is stranded, carefully twist the strands together as tightly as possible.

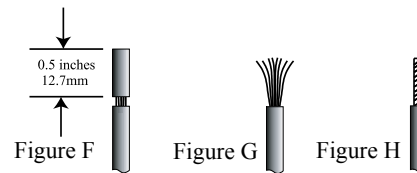

- Notes:
1. If desired, the twisted ends can be tinned with solder to keep the strands together.
 2. The prepared bare wire cable ends may be inserted into spade lug connectors.
 3. Banana plugs are for use in the United States and Canada only.

Banana Plugs are for use in the United States and Canada only:

2. Attach the previously prepared bare wire cable ends into the banana plugs and secure the connections. Refer to figure I.
3. Rotate the Output Terminal Post clockwise until it is finger tight. Refer to figure J. Then using the McIntosh Wrench, rotate the top of the Output Terminal one quarter of a turn (90°). **Do not over tighten.** Refer to figure E.
4. Referring to figure K, connect the Loudspeaker hookup cables with banana plugs into the hole at the top of the terminal to the MA7900 Negative Output Terminal and Positive Output Terminal identified as 2Ω (ohms), 4Ω (ohms) or 8Ω (ohms) connection to match the impedance of the Loudspeaker, being careful to observe the correct polarities.

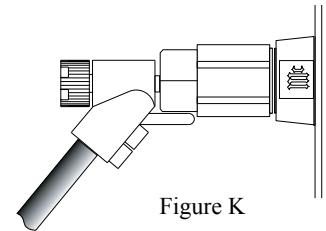
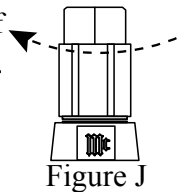
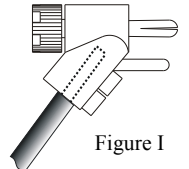

Note: The illustration located on the separate folded sheet “Mc2B” is for connection to an 8Ω (ohms) Loudspeaker.

If the Loudspeaker’s impedance is in-between the available connections, use the nearest lower impedance connection. Refer to “General Information” Note 6 on page 4 for additional information.

WARNING: Loudspeaker terminals are hazardous live and present a risk of electric shock. For additional instruction on making Loudspeaker Connections contact your McIntosh Dealer or McIntosh Technical Support.

5. Connect the MA7900 power cord to an active AC outlet.

Spade Lug or Wire Connections:

6. Connect the Loudspeaker hookup cables to the MA7900 Negative Output Terminal and Positive Output Terminal identified as 2Ω (ohms), 4Ω (ohms) or 8Ω (ohms) connection to match the impedance of the Loudspeaker, being careful to observe the correct polarities. Insert the spade lug connector or prepared section of the cable end into the terminal side access hole, and tighten the terminal cap until the cable is firmly clamped into the terminals so the lugs or wire cannot slip out. Refer to figures L and M.

Note: The illustration located on the separate folded sheet "Mc2B" is for connection to an 8Ω (ohms) Loudspeaker.

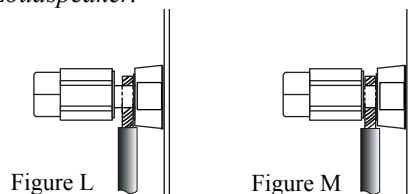

If the Loudspeaker's impedance is in-between the available connections, use the nearest lower impedance connection. Refer to "General Information" Note 6 on page 4 for additional information.

WARNING: Loudspeaker terminals are hazardous live and present a risk of electric shock. For additional instruction on making Loudspeaker Connections contact your McIntosh Dealer or McIntosh Technical Support.

7. Connect the MA7900 power cord to an active AC outlet.



LED illuminates during the time a remote command is sent to the MA7900

Switches the Trigger 1 and/or 2 Power Control Jack(s) On/Off, refer to "Setup, Power Control TRIG 1 and TRIG 2" on page 20 for additional information

Selects a Disc Player, Music Server or Recorder Function. Seek Stations Up or Down the AM/FM Dial. Select and/or enter AM/FM Station Presets and performs various functions on a variety of McIntosh Components

Displays On Screen Functions on the McIntosh Music Server and a variety of other McIntosh Components

Adjusts the volume level up or down

Activates the TRIM Stereo/Mono Mode

Mutes the audio

Selects AM Tuner Operating Functions and Disc Selection on certain McIntosh Disc Players

Selects Functions as a "shift" key when used with the AM or FM push-buttons to select Output 1 or 2

Scrolls through the available MA7900 Inputs

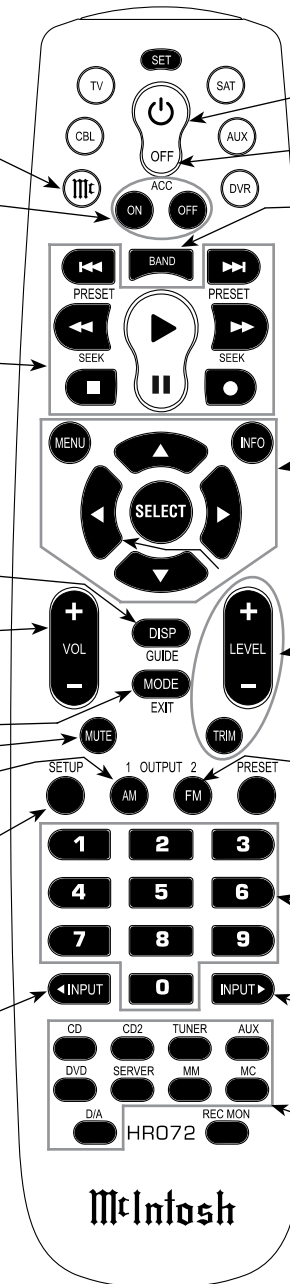

Press to Power the MA7900 ON

Press to Power the MA7900 OFF

Press to change broadcast bands on an external McIntosh Tuner connected. Select certain functions on a variety of McIntosh Components

Selects On Screen Functions on a variety of McIntosh Components

Press TRIM and then the LEVEL Push-buttons to select and adjust various functions

Selects FM Tuner Operating Functions and Track Selection on certain McIntosh CD Players

Use to select tuner presets, direct access an AM/FM Station Frequency, disc tracks or any numbered operation

Scrolls through the available MA7900 Inputs

Selects one of the eight available Audio Sources

Note: Push-buttons whose function is not identified above are for use with other McIntosh Products.

How to use the Remote Control

The supplied HR072 Remote Control is capable of directly controlling the functions of contemporary Source Components connected to the MA7900 via the Data Ports.

- Notes:*
1. If at any time the MA7900 seems unresponsive to HR072 Remote Control Commands press the  Push-button first.
 2. For additional information on using the HR072 Remote Control with the MA7900, please refer to the "How to Operate" section of this Owner's Manual starting on page 24.

Input Source Selection

Press the appropriate Source Push-button to select the desired program source.

Note: When the MA7900 is Off, pressing one of the Source Push-buttons will switch the MA7900 On and it will go to that Input.

Mute

Press the MUTE Push-button to mute the audio in all outputs except the REC OUTPUT. The word MUTE will appear on the Front Panel Display. To un-mute the audio, press the MUTE Push-button again.

Disc, Server and Recorder Functions

Use these push-buttons to operate a DVD Player, CD Player, CD Changer, Music Server or Recorder.





Numbered Push-buttons

Press Push-buttons 0 through 9 to access tuner station presets, tracks on discs or selections on a Music Server.



Disc and Track

Use the AM (disc) and FM (track) Push-buttons when a Disc Player or Music Server is being used.

Tuner Push-buttons

Press the AM or FM Push-button to select the desired broadcast band. Press and release the Seek Up  the band or Seek Down  the band Push-button to seek the next available station. Press and hold a Directional Up  or Down  Push-button to tune continuously from station to station.

Volume



Press the VOLUME Up  or Down  Push-button to raise or lower the listening volume level.

Note: The Record Signals present at REC OUTPUTS are not affected by volume changes.

Pause

Press the Pause  Push-button to perform various functions on a variety of McIntosh Components. It will also pause the playing of a disc or tape player.

Trim

Press the TRIM Push-button until the desired Trim function (Balance, Trim Level, etc.) appears on the Front Panel Display, then press the LEVEL Up  or Down  Push-button to adjust the Trim setting.

Note: Press the TRIM Push-button to recall the last Trim function selected. For additional information on the Trim Functions refer to page 24 thru 27.

Amplifier Selection

Press the BLUE (Setup) Push-button followed by the AM (Output 1) or FM (Output 2) Push-button, to control the rear panel Audio OUTPUTS 1, 2 (ON or OFF) and Power Control TRIG 1 / TRIG 2. These OUTPUTS provide signals to the MA7900 Power Amplifier and/or other accessory component.

Note: Refer to SETUP on page 20 "Power Control Triggers 1 and 2 to change the default setting of "MAIN" to "REMOTE".



INPUT Control allows the selection of various sources for listening and recording.

TRIM allows selection of various types of audio settings. It is also used in the setup mode for various functions

LED indicates when the Left Channel Amplifier POWER GUARD circuit activates

LED indicates when the Right Channel Amplifier POWER GUARD circuit activates

VOLUME Control allows adjustment of the listening level for both channels.

ADJUST is also used in the setup mode for various functions

Meter indicates the Left Channel Output of the amplifier

EQUALIZER Controls increase or decrease the volume levels at the Center Frequencies of 30Hz, 125Hz, 500Hz, 2,000Hz and 10,000Hz

Meter indicates the Right Channel Output of the amplifier

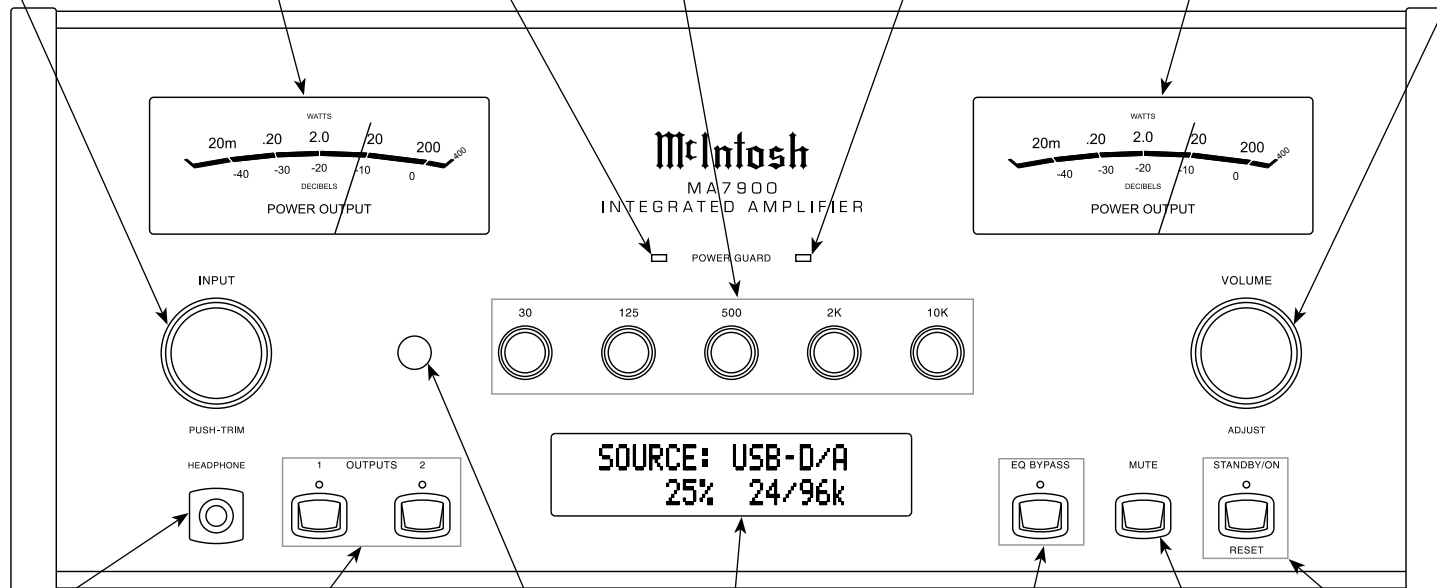

Connection for dynamic type headphones, for private listening

OUTPUT 1 and 2 Push-buttons with indicators, switch Pre-amplifier Output (Loudspeakers) 1 and 2 On or Off

IR Sensor receives commands from a Remote Control

INFORMATION DISPLAY indicates the Sources, Volume, other Audio Settings, Operational Functions and Setup Mode Settings

EQ BYPASS Push-button with indicator, when activated the audio signal bypasses the Equalizer Controls

MUTE Push-button mutes the audio from the Loudspeakers and Headphones

STANDBY/ON Push-button with indicator switches the MA7900 ON or OFF (Standby) and resets the microprocessors

How to Operate the Setup Mode

Your McIntosh MA7900 has been factory configured for default operating settings that will allow immediate enjoyment of superb audio without the need for further adjustments. If you wish to make changes to the factory default settings, a Setup Feature is provided to customize the operating settings using the Front Panel Display. Refer to the MA7900 Front Panel Illustration on the previous page while performing an introduction into operating the Setup Mode, follow the steps below.

Note: If the MA7900 is currently On, proceed to step 2.

1. Press the STANDBY/ON Push-button on the Front Panel or press the  (Power) Push-button on the Remote Control to switch On the MA7900. The MA7900 will go through a brief startup initialization with the Front Panel Display indicating the last used source and volume setting. This is followed by the volume setting indication starting at zero and then increasing to the last used volume setting. Refer to figure 1.



Figure 1

2. Press and hold the INPUT CONTROL until the Front Panel Display indicates “MA7900 V_._, S/N: _____”. The information indicated on the Front Panel Display includes the Model Number, Firmware Version and the Serial Number for this unit; see page 18 for additional information. Refer to figure 2.



Figure 2

3. Now rotate the INPUT CONTROL Clockwise until the Front Panel Display indicates “McIntosh USB Audio, V_._ Firmware”. Refer to figure 3 and to page 18 for additional information.



Figure 3

4. Next, rotate the INPUT CONTROL Clockwise again until the Front Panel Display indicates “SETUP: SOURCE INPUT, CD :RCA” Refer to figure 4.



Figure 4

5. To exit from the Setup Mode, press the INPUT CONTROL and the Front Panel Display will revert back to its normal display. Refer to figure 1.

Default Settings

The Default Settings Chart below indicates the Function Name, Default Setting and the Page Number for additional information.

Default Settings		
Function Name	Setting	Page No.
MA7900	V_._ S/N: _____	18
McIntosh USB Audio	V_._	18
SOURCE INPUT (Reassignment)	RCA	18
SOURCE NAME (Re-assign Input Names)	_____>> _____	19
PASSTHRU	OFF	20

Default Settings		
TRIG 1 Output (Action)	MAIN	20
TRIG 2 Output (Action)	MAIN	20
COMM PORT (Baud Rate)	115200	21
REMOTE (Codes)	NORM	22
POWER MODE (Auto Off)	ENABLED	22

Note: Setup Mode operations should be performed in the order they appear in the Setup Menu as they are interactive.



Firmware Version

The MA7900 functionality is controlled by internal software that is known as Firmware. The MA7900 has two different Firmwares, one is the “System Firmware” (responsible for the basic operation of the MA7900) and the other known as USB Audio Firmware (responsible for the “USB Connection and Conversion” of a Digital Audio Signal from the Computer). The Version of the Firmwares in the MA7900 can be identified at any time by utilizing the Setup Mode.

1. Press and hold the INPUT CONTROL until the Front Panel Display indicates “MA7900 V_._, S/N: _ _ _ _ _”. The number after the “V” is the firmware version and the number after the “S/N” is the serial number of the unit. Refer to figure 2.



Figure 2

2. The number after the character “V” is the Firmware number.
3. Rotate the INPUT CONTROL Clockwise until the Front Panel Display indicates “McIntosh USB AUDIO, V2.10 or higher USB Audio Firmware”. Refer to figure 3.



Figure 3

4. To exit from the Setup Mode, press the INPUT CONTROL and the Front Panel Display will revert back to its normal display.

Source Input Reassignment

The MA7900 provides the ability to reassign High Level Inputs (non-Phono) to either the Balanced Input or one of the two Digital Inputs.

In the first example, the CD Input will be reassigned from the unbalanced CD (RCA Jacks) to the BALANCED Connectors (XRL).

Notes: 1. Any one of the Default Inputs may be switched Off. If any input is switched Off its name will no longer appear on the Front Panel Display when using the INPUT Control, nor is it accessible with the Remote Control.

2. *The Phono MC (Moving Coil) and MM (Moving Magnet) Input are designed for connection of a turntable only and thus non-reassignable. However, the Phono Inputs may be switched Off.*
3. *Only one Input may be assigned at a time to the Balanced or Digital (1 or 2) Connectors. If an already assigned Balanced or Digital connector is to be reassigned to a different Input, the Input currently assigned to the connector first needs to be changed. It can be temporarily set to Off, RCA connector, available Balanced or available Digital connector.*

1. Press and hold the INPUT CONTROL until the Front Panel Display indicates the Setup Mode is active. Then rotate the INPUT CONTROL and select the Setup Menu item “SETUP: SOURCE INPUT, CD :RCA”. Refer to figure 4.



Figure 4

2. Rotate the VOLUME Control until “SETUP: SOURCE INPUT, CD :BALANCED” appears on the Front Panel Display. Refer to figure 5.



Figure 5

The second example will illustrate reassigning the CD2 Input (connected to a SACD/CD Player) from CD2 Input (RCA Jacks) to the DIGITAL 1 Optical Input.

3. Press the VOLUME Control and the CD Input will change to the CD2 INPUT. The Front Panel Display will now indicate “SETUP: SOURCE INPUT, CD2 :RCA”. Refer to figure 6.



Figure 6

4. Rotate the VOLUME Control until “SETUP: SOURCE INPUT, CD2 :DIGITAL 1” appears on the Front Panel Display. Refer to figure 7.



Figure 7

Record any changes made to the various inputs from the default settings in the “Input and Power Control Settings” chart for future reference.

5. To exit from the Setup Mode, press the INPUT CONTROL and the Front Panel Display will revert back to its normal display.

Input and Power Control Settings				
Input Name	Connection Type	New Level (Trim)	Triggers	
			1	2
TUNER				
CD				
CD2				
DVD				
AUX				
SRVR (Rec)				
PHONO MC				
PHONO MM				

Source Input Renaming

The MA7900 Default Input Names (CD, AUX, DVD, etc. as indicated on the Front Panel Display) can be customized with a different name up to nine characters long (My Phone, MCD1100, etc.). The available characters for renaming the input include the following: ! <> * , / - _ 0 1 2 3 4 5 6 7 8 9 A B C D E F G H I K L M N O P Q R S T U V W X Y Z .

In the following example, the AUX Input will be renamed to "MY-PHONE".

1. Press and hold the INPUT CONTROL until the Front Panel Display indicates the Setup Mode is active. Then rotate the INPUT CONTROL and select the Setup Menu item "SETUP: SOURCE NAME, AUX >> AUX". Refer to figure 8.



Figure 8

Note: If the AUX Input is not displayed, press the VOLUME Control repeatedly until it is displayed.

2. Press and hold the VOLUME Control until the character "A" of the name AUX starts flashing. Refer to figure 9.



Figure 9

3. Rotate the VOLUME Control until the character "M" appears. Refer to figure 10.



Figure 10

4. Press the the VOLUME Control until the character "U" starts flashing. Refer to figure 11.



Figure 11

5. Rotate the VOLUME Control until the character "Y" appears. Refer to figure 12.



Figure 12

6. Repeat steps 3 thru 5 until the new name of "MY-PHONE" is indicated on the Front Panel Display. Refer to figure 13.



Figure 13

7. To save the new Input Name press and hold the VOLUME Control until the word SAVED appears momentarily on the Front Panel Display. Refer to figure 14.



Figure 14

Note: When direct accessing the "MY-PHONE" Input using the Remote Control, press the AUX Pushbutton.

Record any changes made to the various default Input Names in the following chart for future reference.

8. To exit from the Setup Mode, press the INPUT CONTROL and the Front Panel Display will revert back to its normal display.

Source Input Renaming	
Default Input Name	New Input Name
TUNER	
CD	
CD2	
DVD	
AUX	
SRVR (Rec)	
PHONO MC	
PHONO MM	



Passthru

The MA7900 can be part of a Multichannel Sound System for SACD, DVD-Audio and Home Theater. The Right and Left Front Channels from an Audio/Video Control Center or Surround Decoder can “Passthru” the Preamplifier Circuitry of the MA7900, and then on to the Power Amplifier Circuitry of the MA7900. The Setup Mode allows the activation of the Passthru Mode and the selection of the specified MA7900 Input Source. In the example below, the Right and Left Front Channels from the Audio/Video Control Center will be connected to the SRVR (Server) Input Jacks on the MA7900. Refer to page 10 for additional connection information.

Notes: 1. The Phono Input Connectors and Digital Input Connectors are not assignable as a Passthru Input.

2. If the Balanced Input Connectors are already reassigned to a given Input, they will not appear in the list of available Inputs for the Passthru Mode.

3. When one of the RCA Inputs is selected as a Passthru Input, it is advisable to remove it from the list of available Inputs by switching it Off. Refer to “Source Inputs Reassignment” starting on page 18.

1. Press and hold the INPUT CONTROL until the Front Panel Display indicates the Setup Mode is active. Then rotate the INPUT CONTROL and select the Setup Menu item “SETUP: PASSTHRU, Source: OFF”. Refer to figure 15.



SETUP: PASSTHRU
Source: OFF

Figure 15

2. Rotate the VOLUME Control until “SETUP: PASSTHRU, Source: SRVR<RCA>” appears on the

Front Panel Alphanumeric Display. Refer to figure 16.



SETUP: PASSTHRU
Source: SRVR<RCA>

Figure 16

3. To exit from the Setup Mode, press the INPUT CONTROL and the Front Panel Display will revert back to its normal display.

Power Control Triggers 1 and 2

By default the Power Control TRIGGER 1 and TRIGGER 2 Outputs function the same as the MAIN Power Control Jack, switching On/Off with the MA7900. Trigger 1 and 2 are also reassignable to activate when the ACC ON/OFF Push-buttons on the Remote Control are used, when a given Input (or Inputs) is selected or when the Front Panel (or Remote Control) OUTPUT 1 or OUTPUT 2 Push-buttons are pressed.

EXAMPLE ONE:

The Power Control Trigger 1 Output will be set to function via the Remote Control ACC Push-buttons.

1. Press and hold the INPUT CONTROL until the Front Panel Display indicates the Setup Mode is active. Then rotate the INPUT CONTROL until the Setup Menu item “SETUP: TRIG1 OUTPUT, Action: MAIN” appears on the Front Panel Display. Refer to figure 17.



SETUP: TRIG1 OUTPUT
Action: MAIN

Figure 17

2. Rotate the VOLUME Control until “SETUP: TRIG1 OUTPUT, Action: REMOTE” appears. Refer to figure 18.



SETUP: TRIG1 OUTPUT
Action: REMOTE

Figure 18

3. To exit from the Setup Mode, press the INPUT CONTROL and the Front Panel Display will revert back to its normal display.

EXAMPLE TWO:

This example will use selection of the Tuner FM Input to switch the Trigger 1 Output On.

4. Press and hold the INPUT CONTROL until the Front Panel Display indicates the Setup Mode is active. Then rotate the INPUT CONTROL until the Setup Menu item “SETUP: TRIG1 OUTPUT, Action: MAIN” appears on the Front Panel Display. Refer to figure 17.
5. Rotate the VOLUME Control until “SETUP: TRIG1 OUTPUT, Action: SOURCE” appears. Refer to figure 20.



SETUP: TRIG1 OUTPUT
Action: SOURCE

Figure 20

6. Rotate the INPUT Control until the first Source Input Menu item “SETUP: TRIG1 OUTPUT, Source: _____ OFF” appears on the Front Panel Display. Refer to figure 21.



SETUP: TRIG1 OUTPUT
Source: AUX OFF

Figure 21

Notes: 1. By default all the Source Inputs are set to Off.

2. Any combination of Source Inputs from one to all may be assigned to either Trigger (1 or 2) or both Triggers.

7. Press the VOLUME Control repeatedly until the Source Input Menu item “SETUP: TRIG1 OUTPUT, Source: TUNER OFF” appears on the Front Panel Display. Refer to figure 22.

```

SETUP: TRIG1 OUTPUT
Source: Tuner OFF
  
```

Figure 22

8. Rotate the VOLUME Control until “SETUP: TRIG1 OUTPUT, Source: TUNER ON” appears. Refer to figure 23.

```

SETUP: TRIG1 OUTPUT
Source: Tuner ON
  
```

Figure 23

9. To exit from the Setup Mode, press the INPUT CONTROL and the Front Panel Display will revert back to its normal display.

EXAMPLE THREE:

The Trigger 1 and Trigger 2 Outputs will be assigned to the OUTPUT 1 or OUTPUT 2 Push-buttons.

10. Press and hold the INPUT CONTROL until the Front Panel Display indicates the Setup Mode is active. Then rotate the INPUT CONTROL until the Setup Menu item “SETUP: TRIG1 OUTPUT, Action: MAIN” appears on the Front Panel Display. Refer to figure 17.
11. Rotate the VOLUME Control until “SETUP: TRIG1 OUTPUT, Action: OUT 1” appears. Refer to figure 24.

```

SETUP: TRIG1 OUTPUT
Action: OUT 1
  
```

Figure 24

12. Rotate the INPUT CONTROL until the Setup Menu item “SETUP: TRIG2 OUTPUT, Action: MAIN” appears on the Front Panel Display. Refer to figure 25.

```

SETUP: TRIG2 OUTPUT
Action: MAIN
  
```

Figure 25

13. Rotate the VOLUME Control until “SETUP: TRIG2 OUTPUT, Action: OUT 2 ” appears. Refer to figure 26.

```

SETUP: TRIG2 OUTPUT
Action: OUT 2
  
```

Figure 26

Record any changes made to the various inputs from the default settings in the “Input and Power Control Settings” chart on page 19 for future reference.

14. To exit from the Setup Mode, press the INPUT CONTROL and the Front Panel Display will revert back to its normal display.

Comm Port Baud Rate

The MA7900 may be remotely controlled from other equipment connected to the Rear Panel RS232C Jack. The speed at which the MA7900 communicates (8 bit, no parity and 1 stop bit) with other equipment is adjustable from 9,600 bits per second to 115,200 bits per second. To change from the default speed of 115,200 bits per second, perform the following steps:

1. Press and hold the INPUT CONTROL until the Front Panel Display indicates the Setup Mode is active. Then rotate the INPUT CONTROL until the Setup Menu item “SETUP: COMM PORT, BAUD RATE: 115200” appears on the Front Panel Display. Refer to figure 27.

```

SETUP: COMM PORT
BAUD RATE: 115200
  
```

Figure 27

2. Rotate the VOLUME Control to select the desired speed.
3. To exit from the Setup Mode, press the INPUT CONTROL and the Front Panel Display will revert back to its normal display.



Remote Control Codes

The Remote Control included with the MA7900 utilizes the NORMal McIntosh Control Codes. The Second Set of Control Codes the MA7900 will respond to is referred to as the ALTErnate Codes. When the MA7900 is used in the same location as another McIntosh Preamplifier and/or A/V Control Center, the ALTErnate Codes are used. This will prevent the Remote Control from affecting the operation of both units at the same time. To activate the Remote Control ALTErnate Codes perform the following steps:

1. Press and hold the INPUT CONTROL until the Front Panel Display indicates the Setup Mode is active. Then rotate the INPUT CONTROL until the Setup Menu item “SETUP: REMOTE, CODES: NORM” appears on the Front Panel display. Refer to figure 27.

SETUP: REMOTE
CODES: NORM

Figure 27

2. Rotate the VOLUME Control to select “SETUP: REMOTE, CODES: ALT”. Refer to figure 28.

SETUP: REMOTE
CODES: ALT

Figure 28

3. To exit from the Setup Mode, press the INPUT CONTROL and the Front Panel Display will revert back to its normal display.
4. To change the MA7900 Remote Control to the Alternate Codes perform the following steps:
 - A. Press the “Mc” Push-button.
 - B. Press the SET Push-button until the “Mc” Push-button flashes twice.
 - C. Press the 3, 2, 4, 2 and 9 Push-buttons within 5 seconds.
 - D. The “Mc” Push-button flashes twice.

Note: To reset the Remote Control to normal codes perform steps A and B then enter 3, 2, 4, 2 and 8 for step C.

5. Press the VOLUME UP/DOWN Push-button on the Remote Control to verify proper operation.

Power Mode

The MA7900 incorporates an Auto Off Feature, which automatically places the preamplifier into the Power Saving Standby/Off Mode. This occurs approximately 30 minutes after there has been an absence of audible audio signals on the selected input (on either channel) or user activity (includes changes to any of the Operation Functions such as source selection, volume adjustment, etc). If it is desirable to disable the Auto Off Feature perform the following steps:

1. Press and hold the INPUT CONTROL until the Front Panel Display indicates the Setup Mode is active. Then rotate the INPUT CONTROL until the Setup Menu item “SETUP: POWER MODE, Auto Off: Enabled” appears on the Front Panel Display. Refer to figure 29.

SETUP: POWER MODE
Auto Off: Enabled

Figure 29

2. Rotate the VOLUME Control until “SETUP: POWER MODE, Auto Off: Disabled” appears on the Front Panel Display. Refer to figure 30.

SETUP: POWER MODE
Auto Off: Disabled

Figure 30

3. To exit from the Setup Mode, press the INPUT CONTROL and the Front Panel Display will revert back to its normal display.







How to Operate the MA7900

Power On and Off

The Red LED above the STANDBY/ON Push-button lights to indicate the MA7900 is in Standby mode. To switch ON the MA7900, Press the STANDBY/ON Push-button on the Front Panel or press the  (Power) Push-button on the Remote Control. The MA7900 will go through a brief startup initialization with the Front Panel Displays indicating Power Guard is active, last used source and volume setting. This is followed by the volume setting indication starting at zero and then increasing to the last used volume setting. Refer to figures 50, 51, 52 and 53. To switch OFF the MA7900, press the STANDBY/ON Push-button on the Front Panel or the OFF Push-button on the Remote Control.

Note: For an explanation of the Remote Control Push-button functions, refer to pages 14 and 15.



Figure 51

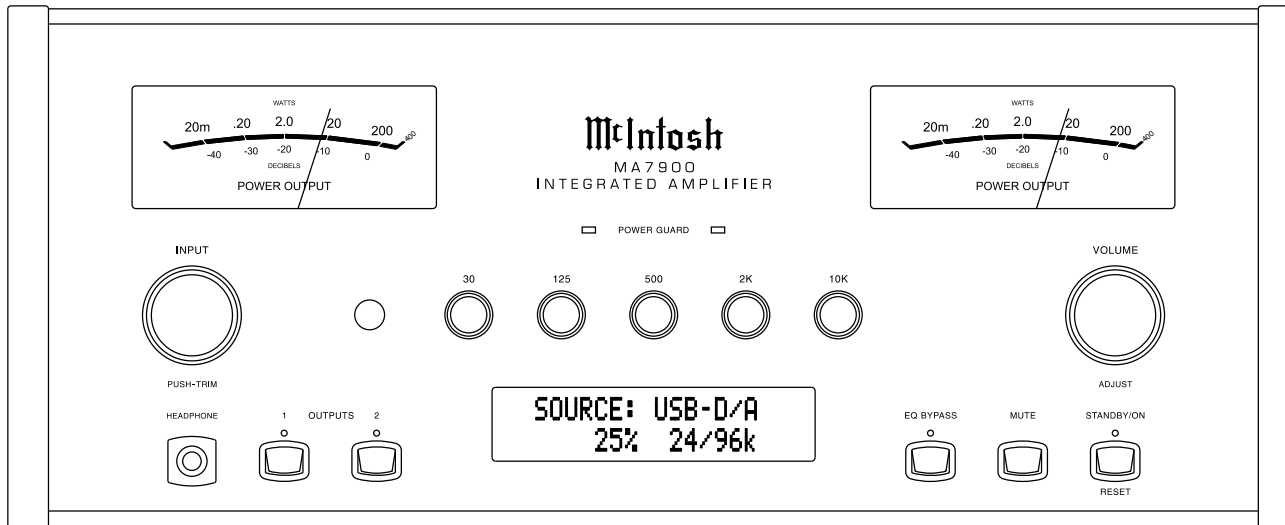

Figure 50



Figure 52

Source Selection

Rotate the INPUT Control to select the desired source or press the appropriate push-button on the Remote Control. Refer to figures 50 and 53.

Volume Control

Rotate the Front Panel VOLUME Control or use the VOLUME Up▲ or Down▼ Push-buttons on the Remote Control for the desired listening level. Refer to figures 50 and 53.

Trim Functions

The MA7900 has various Trim Selections with Adjustments. The Trim Functions include Balance, Trim level, Equalizer Mode, Mono/Stereo, Phono (MC), Display Brightness, Digital Audio and Meter Back-

light. The Trim Settings are stored in memory independently for each Input Source Selected, except the Meter Illumination and Digital Audio Display settings of On or Off, which are the same for all inputs.

The selection and adjustment of all Trim Functions may be performed by first pressing the Front Panel INPUT/TRIM Control. Then rotate the INPUT/TRIM Control to select the desired Trim Function. This is followed by rotating the VOLUME/ADJUST Control to make a change/adjustment in the Trim Setting.

The Remote Control TRIM Push-Button together with the LEVEL + / - Push-button may also be used. Refer to figures 50 and 53.

After approximately 5 seconds the Display returns to indicate the Source Selection and Volume Level.

BALANCE

Listening balance varies with different program sources, room acoustics and listening positions relative to the Loudspeakers. Use the Balance (Trim Function) as needed to achieve approximately equal listening vol-

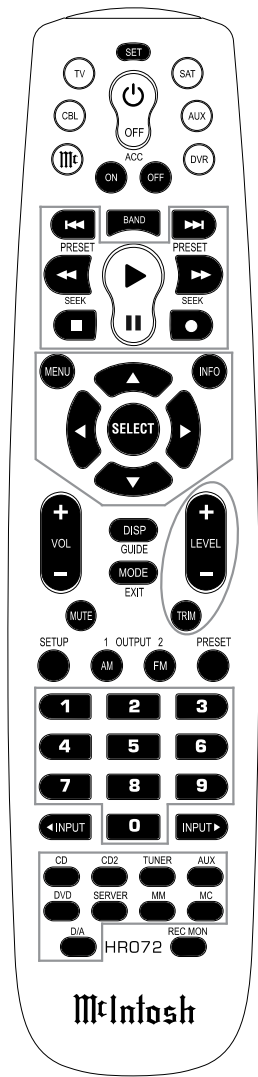

Figure 53

ume levels in each Loudspeaker. To adjust the Balance perform the following:

1. Press the TRIM Push-button repeatedly on the Remote Control until “BALANCE 0 dB” appears on the Front Panel Display. Refer to figure 54.



Figure 54

Note: The Front Panel INPUT/TRIM Control may also be used.

2. Rotate the VOLUME Control or press the LEVEL +/- Push-buttons on the Remote Control to emphasize the Right Channel (refer to figure 55) or the Left Channel (refer to figure 56).



Figure 55



Figure 56

The Front Panel Display indicates the Balance changes in steps from 0 to 50dB. After approximately 5 seconds, the Display returns to indicate the Source Selection and Volume Level. To verify the Balance setting without changing it, use the TRIM Push-button and select Balance.

EQUALIZER MODE

The built-in five band Frequency Equalizer provides more precise adjustment of sound than Bass and Treble Controls. By default the Equalizer is active for all Input Sources however, any Input Source may be assigned to bypass the Equalizer. To bypass the Equal-

izer for a given Input Source, perform the following steps:

Note: The audio signal present at the RECORD OUT Jacks is unaffected by the Equalizer settings.

1. Select the desired Input Source.
2. Select “EQUALIZER MODE, _____: Enable” as indicated on the Front Panel Information Display. Refer to figure 57.



Figure 57

3. Set the EQUALIZER MODE to be either enabled or bypassed. Refer to figure 58.



Figure 58

After approximately 5 seconds the Information Display returns to indicate the Source Selection and Volume Level.

TRIM LEVEL

Source Components can have slightly different volume levels resulting in the need to readjust the MA7900 Volume Control when switching between different sources. The MA7900 allows the adjustment of levels for each of the Source Inputs for the desired same relative volume. The CD and SERVER Inputs are used in the following example.

Note: The range of adjustment is ± 6dB. The signal Level present at the RECORD OUT Jacks is unaffected by any changes in the Setup Level adjustment. The level adjustments made are retained in permanent memory. They can be changed during operation of the MA7900 by performing a Trim Level Procedure.

1. Press the CD Push-button on the Remote Control and press the VOLUME Push-button +/- for the desired listening level.
2. Repeatedly press the TRIM Push-button on the Remote Control until “TRIM LEVEL: 0.0dB, Min Max” appears on the Front Panel Display. Refer to figure 59.

Note: The CD Input is serving as a reference level or choose another source frequently listened to. The Input Source should be set to a reference Level (Trim) of 0.0dB.



Figure 59

3. Press the SERVER Push-button on the Remote Control and note if the relative volume is louder or quieter than the volume level of the CD.
4. Repeatedly press the TRIM Push-button on the Remote Control until “TRIM LEVEL: 0.0dB, Min Max” appears on the Front Panel Display. Refer to figure 59.
5. Press the TRIM LEVEL +/- Push-button on the Remote Control to achieve the same relative volume as the CD Input. In our example the relative volume level of the Server Input is louder than the CD Input, so the trim level for the Server Input is reduced to -2.5 dB. Refer to figure 60.



Figure 60

6. Repeat steps 1 thru 4 until the relative volume is the same between the CD and SERVER Inputs.
7. Repeat the above steps for the remaining inputs with component sources connected until they



How to Operate the MA7900, con't

all have the same relative volume levels. Record any changes made to the various inputs from the default settings in the “Input and Power Control Settings” chart on page 19.

After approximately 5 seconds the Display returns to indicate the Source Selection and Volume Level.

MONO/STEREO MODE

By default the Stereo Mode is active for all Input Sources however, any Input Source may be assigned to Mono Mode. To change Stereo Mode to Mono for a given Input Source, perform the following steps:

1. Select the desired Input by using the direct access Input Push-button on the Remote Control.
2. Press the TRIM Push-button on the Remote Control until “MONO/STEREO MODE, _____ : Stereo” appears on the Front Panel Display. Refer to figure 61.

MONO / STEREO MODE
TUNER : Stereo

Figure 61

3. Press TRIM LEVEL + / - Push-button to select the MONO Mode. Refer to figure 62.

MONO / STEREO MODE
TUNER : Mono

Figure 62

After approximately 5 seconds the Display returns to indicate the Source Selection and Volume Level.

PHONO ADJUSTMENTS

When the Phono MC Input is selected, an additional TRIM SELECT FUNCTION becomes available for adjustment. Perform the following steps to make the Phono Trim Adjustments:

1. Select Phono MC Source Input.
2. Press the TRIM Push-button on the Remote Control until “PHONO CARTRIDGE, Moving Coil: 200 Ohm” appears on the Front Panel Display. Refer to figure 63.
3. Press TRIM LEVEL + / - Push-button to select the desired phono cartridge loading value (50, 100,

PHONO CARTRIDGE
Moving Coil: 200 Ohm

Figure 63

200, 400 or 1000) Ohms that comes closest to the Phono Cartridge makers recommended value. After approximately 5 seconds the Alphanumeric Display returns to indicate the Source Selection and Volume Level.

DISPLAY BRIGHTNESS

The Front Panel Display Brightness may be changed from the default setting. The MA7900 will remember two brightness preferences, one with the Meters Illuminated and one without Meter Illumination. For each preference there are four brightness settings for the Display. The Display Brightness setting may be varied 1 (Dim) to 4 (Bright). Follow the steps below for reducing the Display Brightness (with the Meter Illumination On):

1. Press the TRIM Push-button on the Remote Control until “DISPLAY, Brightness: 3” appears on the Front Panel Display. Refer to figure 64.

DISPLAY
Brightness: 3

Figure 64

2. Press TRIM LEVEL + / - Push-button to select the desired Brightness.

Note: To change the Display Brightness preference with Meter Illumination Off, first switch Off the Meter Illumination on the next page and then change the Display Brightness Setting.

After approximately 5 seconds the Display returns to indicate the Source Selection and Volume Level.

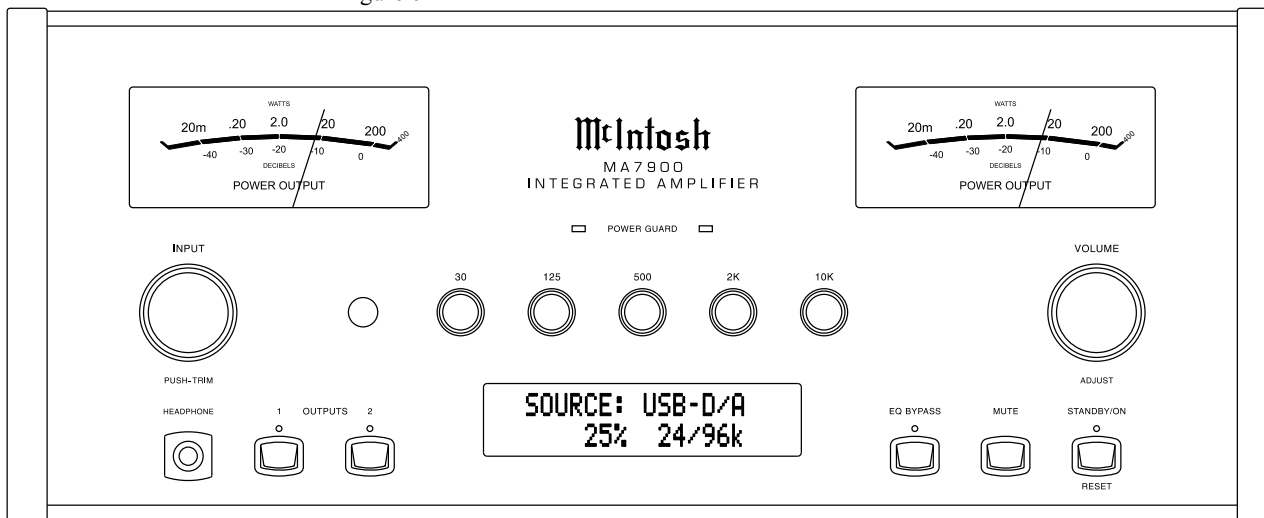

Figure 50

DIGITAL AUDIO DISPLAY

By default the Digital Audio Display is switched Off. To display information about the type of digital signal present when any one of the three digital inputs is selected, perform the following steps:

1. Select one of the Inputs assigned to an active digital source.

Note: The USB-D/A Input may also be selected when the MA7900 is connected to a computer.

2. Press the TRIM Push-button on the Remote Control until "DIGITAL AUDIO, Display Info: On" is indicated on the Front Panel Display. Refer to figure 65.



Figure 65

3. If it is not desirable to display the information use the TRIM LEVEL +/- Push-button to switch it Off. Refer to figure 66.



Figure 66

After approximately 5 seconds the Display will return to indicate the Source Selection and Volume Level.

METER BACKLIGHT

The MA7900 Front Panel Meter Illumination may be switched On or Off by performing the following:

1. Press the TRIM Push-button on the Remote Control until "METER BACKLIGHT, Lights: On" appears on the Front Panel Display. Refer to figure 67.



Figure 67

2. Press TRIM LEVEL +/- Push-button to switch Off the Meter Illumination. Refer to figure 68.



Figure 68

After approximately 5 seconds the Display returns to indicate the Source Selection and Volume Level.

- Notes:*
1. For information on how the Front Panel Display Brightness can change with the Meter Illumination On/Off Setting, refer to page 26 "Display Brightness".
 2. Meter Illumination of recent McIntosh Power Amplifiers will also switch On/Off when connected to the MA7900 via a power control cable.

Equalizer Bypass

Press the Front Panel EQ BYPASS Push-button to remove the MA7900 Equalizer Control Circuitry from the signal path for the currently selected Input Source. The LED above the EQ BYPASS Push-button will illuminate. Refer to figure 50. The MA7900 remembers for each selected Input whether the Equalizer Control Circuitry is deactivated. To reactivate the Equalizer Control Circuitry for the currently selected Input Source press the EQ BYPASS Push-button.

- Note:*
1. The audio signal present at the RECORD OUT Jacks is unaffected by the Tone Circuitry.
 2. The EQ BYPASS can also be accessed by the TRIM Function, refer to page 24.

Trim

Press the Front Panel INPUT/TRIM Control to activate the MA7900 Trim Functions. Rotate the Front Panel INPUT/TRIM Control to select the desired Trim Function and then rotate the VOLUME/ADJUST Control to vary or make changes. Refer to figure 50. The Remote Control TRIM and LEVEL +/- Push-buttons may also be used. Approximately 5 seconds after Trim Function Selection and/or adjustments have stopped the MA7900 will switch off the Trim Mode.

Mute

Press the MUTE Push-button to Mute the Audio in Output 1 (Loudspeakers), Output 2 and Headphones. The audio signals present at the REC OUTPUT jacks are not effected by activating the mute function. The Front Panel Display will indicate the Source Name and with the word MUTE in place of the actual volume setting. Refer to figure 69.



Figure 69

Pressing the Mute Push-button a second time or adjusting the volume control will un-mute the MA7900.

Headphones Jack

Connect a pair of dynamic headphones to the Headphones Jack for private listening. Press OUTPUT 1 and/or 2 Push-buttons to mute the Loudspeakers. Refer to figure 50.

Note: The Headphone Output is optimized for impedances ranging from 20 to 600 ohms.



How to Operate the MA7900, con't

Power Output Meters

The MA7900 Power Output Meters indicate the power delivered to the Loudspeakers. Refer to figure 70.

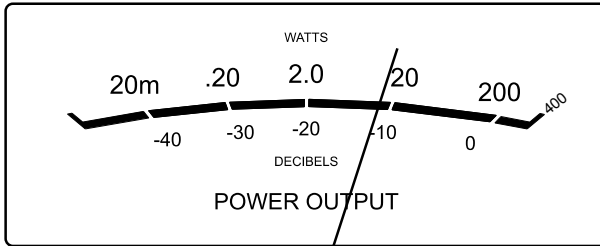

Figure 70

The meters respond to all the musical information being produced by the Amplifier. They indicate to an accuracy of at least 95% of the power output with only a single cycle of a 2,000Hz tone burst.

Power Guard

During normal operation, the Front Panel Power Guard Indicators will momentarily illuminate during peaks in the audio signals. In the event the MA7900

over heats, due to improper ventilation, high ambient temperature and/or impedance mismatch, the internal protection circuits will activate. The Front Panel Power Guard Indicators will continuously illuminate and the audio will be muted. When the MA7900 has returned to a safe operating temperature, normal operation will resume.

How To Make a Recording

1. Select the desired signal source you wish to record by using the Front Panel INPUT Control or the appropriate Source Push-button on the Remote Control.
2. Adjust the record level using the recorder volume control and proceed with the recording process.
3. To listen to the playback of the program source just recorded select the SERVER Input.

Note: The MA7900 REC OUTPUTS are not affected by the VOLUME, BALANCE or TONE Control Settings.

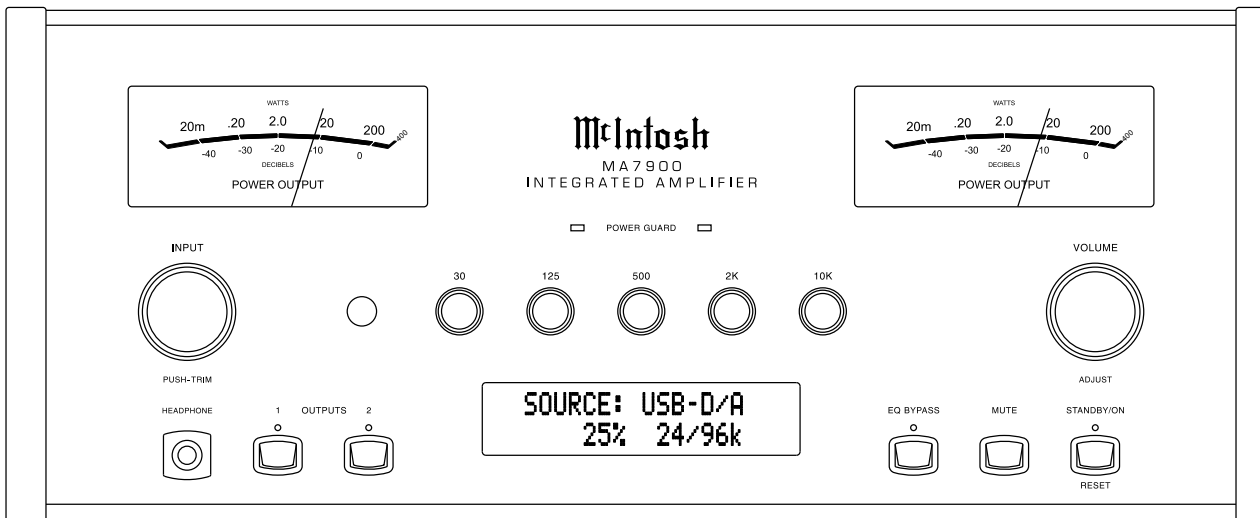

Figure 50

Using a Separate Power Amplifier

There are two different ways to use a separate power amplifier with a MA7900. The first way is to use the separate amplifier instead of the MA7900 built-in Power Amplifier. Connect the Loudspeakers to the separate power amplifier and remove the McIntosh Jumpers that are located between the OUTPUTS 1 Jacks and the PWR AMP INPUT Jacks. Refer to figure 71.

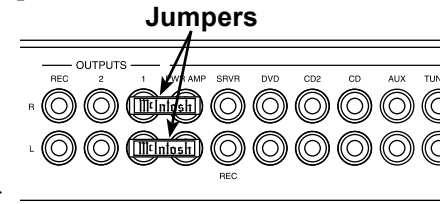

Figure 71

Note: The McIntosh Jumpers must be connected, between the above mentioned jacks, when the MA7900 Internal Power Amplifier is to be used.

The second way is to use both a separate power amplifier and the MA7900 built-in Power Amplifier. Connect one pair of Loudspeakers to the separate power amplifier and the second pair to the MA7900. Refer to the MA7900

Output Connection Diagrams located on the separate folded sheet "Mc2B" and figure 72.

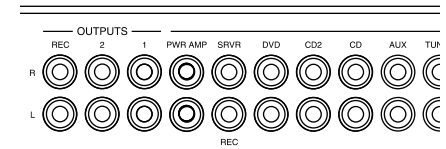

Figure 72

Note: The MA7900 VOLUME Control will affect the sound level of all the Loudspeakers.

Using Output 2

The MA7900 has provisions for connecting an external Power Amplifier (to drive Loudspeakers in another room) and an external sensor for remote operation of the MA7900 from that room. With an external Power Amplifier connected (as illustrated on the McIntosh Connection Diagram separate sheet "Mc2B"), press

the Front Panel OUTPUT 2 Push-button or press on the Remote Control the 2nd Push-button followed by pressing the OUTPUT 2 Push-button to switch On or Off the external Power Amplifier.

Passthru

When the MA7900 is connected together with a Mc-Intosh Multichannel A/V Control Center or Surround Decoder and has the PASSTHRU Mode activated, it will automatically turn-on when the A/V Control Center or Surround Decoder is turned On. It will indicate on the Front Panel Display "PASSTHRU". Refer to figure 73.



Figure 73

The MA7900 OUTPUT 1 / OUTPUT 2 Front Panel Push-buttons are active when in the Passthru Mode. The other Front Panel Controls and Push-buttons are deactivated as long as the Passthru Mode is active.

Equalizer Controls

The MA7900 Equalizer has five Frequency Controls which will raise or lower by 12dB, the amplitude of the band of frequencies centered at the frequency marked above the controls. The center frequencies of these controls are at 30Hz, 125Hz, 500Hz, 2,000Hz and 10,000Hz. Both Left and Right Channels are affected. At the center detent or flat position of the controls, the tone circuit components are removed from the signal path.

The illustration to the right shows the fundamental frequency range of acoustical musical instruments and the human voice. It also shows the range of adjustment of frequencies for each of the Equalizer Controls of the MA7900 at the +6dB and -6dB points.

Fundamental Frequencies of Acoustical Musical Instruments and the Human Voice

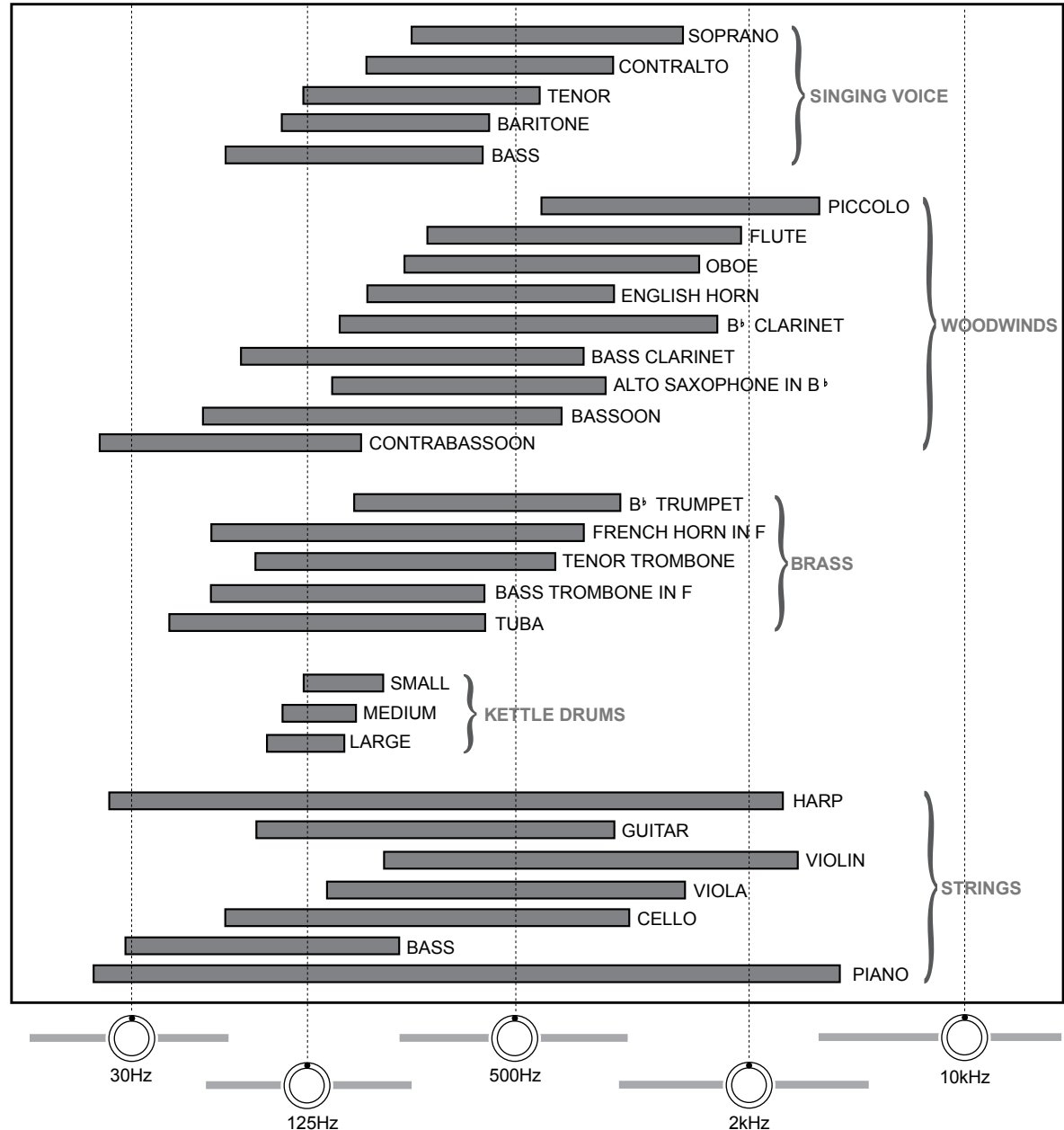



How to Operate the MA7900, con't

Optical and Coaxial Digital Inputs

When a Digital Input (Optical or Coaxial Connection) on the MA7900 is selected the Front Panel Display will indicate when a signal is present “2CH PCM”. Refer to figure 74. During the time there is no Digital



Figure 74

Signal present the display will indicate “SILENT”. Refer to figure 75.



Figure 75

USB Input Operation with a Computer

The MA7900 USB-D/A Input provides the capability to playback music from a computer, when the computer is connected to the rear panel USB D/A connector. The MA7900 USB Input is compatible with both PC Computers using Microsoft® Windows® (XP with Service Pack 3, Vista with Service Pack 1 and Windows 7) and the Apple® Macintosh® Computers using OS-10.6 with the latest update.

When using a PC Computer with Windows, a special McIntosh USB Audio Software Driver needs to be installed on the PC Computer. The driver needs to be installed before connecting the MA7900 USB Input to an USB Port on the computer.

Note: If an Apple Macintosh computer is used with the MA7900, no additional driver is required.

The McIntosh USB Audio Windows Driver and Installation and Operation Guide are available for download from the McIntosh Web Site:

<http://www.mcintosh-labs.com/us/support/Pages/Manuals.aspx>

Under “Product Category” select Preamplifiers and under “Model Number” select MA7900, then click on “Select”. When the MA7900 information appears, download the “McIntosh Audio Windows Driver Installation and Operation Guide” and “McIntosh USB Audio Windows Driver V_ . _”. Follow the instructions in the Guide and after the USB Driver is installed, connect the MA7900 to the PC Computer.

Note: When computer application programs and various computer hardware components conform to the Microsoft® Windows® and Apple® Macintosh® standards, they should also work well when used in conjunction with the MA7900 USB Input. If you are experiencing difficulty with a specific computer hardware component or computer application program, contact the manufacturer of the product.

The MA7900 Front Panel Display will indicate the Bit and Sampling Rate of the incoming digital signal. Refer to figure 76.



Figure 76

Reset of Microprocessors

In the unlikely event the controls of the MA7900 stop functioning, the microprocessors can be reset by performing the following:

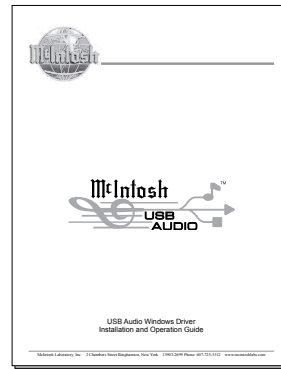

1. Press the STANDBY/ON Push-button until the STANDBY/ON Indicator switches Off.
2. When the MA7900 cycles On then Off, release the STANDBY/ON Push-button.
3. When the STANDBY/ON LED is illuminated press the STANDBY/ON Push-button, the MA7900 will resume normal operation.

Note: This can be performed with the MA7900 On or in the Standby Mode.

Resetting the MA7900 to default settings

If it becomes desirable to reset all the adjustable settings (Setup and Trim Settings) to the factory default values, perform the following:

1. Press in and hold the INPUT/TRIM Control and the VOLUMES/ADJUST Control. The Front Panel Display will indicate “FACTORY RESET”. Refer to figure 77.



Figure 77

2. When the Front Panel Display indicates “FACTORY RESET, COMPLETE” release the two controls. Refer to figure 78.



Figure 78

3. Press the STANDBY/ON Push-button and the MA7900 will resume operation.





Amplifier Specifications

Power Output

200 watts is the minimum sine wave continuous average power output per channel, both channels operating

Output Load Impedance

2, 4 or 8 ohms

Rated Power Band

20Hz to 20,000Hz

Total Harmonic Distortion

0.005% maximum with both channels operating from 250 milliwatts to rated power, 20Hz to 20,000Hz

Dynamic Headroom

2.0dB

Frequency Response

+0, -0.5dB from 20Hz to 20,000Hz
 +0, -3dB from 10Hz to 100,000Hz

Preamplifier Output 1 and 2 (for rated input)

1.4V unbalanced (8V Maximun)

Sensitivity (for rated output)

High Level, 250mV unbalanced, 500mV balanced
 Phono MM, 2.5mV
 Phono MC, 0.25mV
 Power Amp In, 1.4V

Signal To Noise Ratio (A-Weighted)

High Level, 95dB below rated output
 Phono MM, 84dB below 5mV input
 Phono MC, 82dB below 0.5mV input
 Power Amplifier, 113dB below rated output

Intermodulation Distortion

0.005% maximum, if the instantaneous peak power is 400 watts or less per channel with both channels operating for any combination of frequencies from 20Hz to 20,000Hz

Wide Band Damping Factor

Greater than 40

Input Impedance

High Level, 20K ohms
 Phono MM, 47K ohms; 50pF
 Phono MC, 50, 100, 200, 400 or 1,000 ohms; 100pF
 Power Amp In, 10K ohms

Maximum Input Signal

High Level, 8V unbalanced, 16V balanced
 Phono MM, 80mV
 Phono MC, 8mV
 Power Amplifier In, 16V

Preamplifier Output Impedance

220 ohms

Headphone Impedance

20 to 600 ohms

Power Guard

Less than 2% THD with up to 16dB overdrive at 1,000Hz

Voltage Gain

High Level to Rec Output: 0dB
 High Level to Output 1 and 2: 15dB
 Phono MM to Rec Output: 40dB
 Phono MC to Rec Output: 60dB

Voltage Gain, con't

Phono MM to Output 1 and 2: 55dB
 Phono MC to Output 1 and 2: 75dB
 Power Amplifier: 29dB

Equalizer Controls

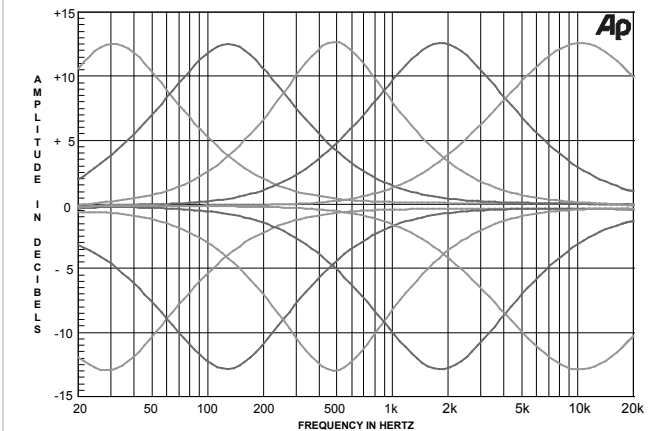

Digital Input Sample Rates

Optical: 16Bit, 24Bit - 32kHz to 96kHz
 Coaxial: 16Bit, 24Bit - 32kHz to 96kHz
 USB: 16Bit, 24Bit, 32Bit - 32kHz to 192kHz

Power Control and Trigger Output

12VDC, 25mA



General Specifications

Power Requirements

Field AC Voltage conversion of the MA7900 is not possible. The MA7900 is factory configured for one of the following AC Voltages:

- 100 Volts, 50/60Hz at 5.2 amps
- 110 Volts, 50/60Hz at 4.4 amps
- 120 Volts, 50/60Hz at 4.4 amps
- 220 Volts, 50/60Hz at 2.45 amps
- 230 Volts, 50/60Hz at 2.35 amps
- 240 Volts, 50/60Hz at 2.25 amps
- Standby: Less than 0.25 watt

Note: Refer to the rear panel of the MA7900 for the correct voltage.

Overall Dimensions

- Width is 17-1/2 inches (44.45cm)
- Height is 7-5/8 inches (19.37cm) including feet
- Depth is 22 inches (55.88cm) including the Front Panel, Knobs and Cables

Weight

75 pounds (34.1 kg) net, 93 pounds (42.3 kg) in shipping carton

Shipping Carton Dimensions

- Width is 29-1/2 inches (74.93cm)
- Depth is 29 inches (73.66cm)
- Height is 17 inches (43.18cm)



Packing Instructions

In the event it is necessary to repack the equipment for shipment, the equipment must be packed exactly as shown below. It is very important that the four plastic feet are attached to the bottom of the equipment. Two #10 x 2-1/2 inch screws and washers must be used to fasten the unit securely to the bottom pad and wood skid. This will ensure the proper equipment location on the bottom pad. Failure to do this will result in shipping damage.

Use the original shipping carton and interior parts only if they are all in good serviceable condition. If a shipping carton or any of the interior part(s) are needed, please call or write Customer Service Department of McIntosh Laboratory. Refer to page 3. Please see the Part List for the correct part numbers.

MA7900 Packing Material List

Quantity	Part Number	Description
1	033888	Shipping carton
4	033887	End Cap
1	033697	Inner carton
1	033725	Top pad
1	034301	Bottom pad
1	034480	Wood skid
2	017218	Plastic foot (spacer)
2	401204	#10 x 2-1/2 inch wood screw
2	404033	#10 flat washer 1-3/4 inch
4	017937	Plastic foot
4	400159	#10-32 x 3/4 machine screw
4	404080	#10 flat washer

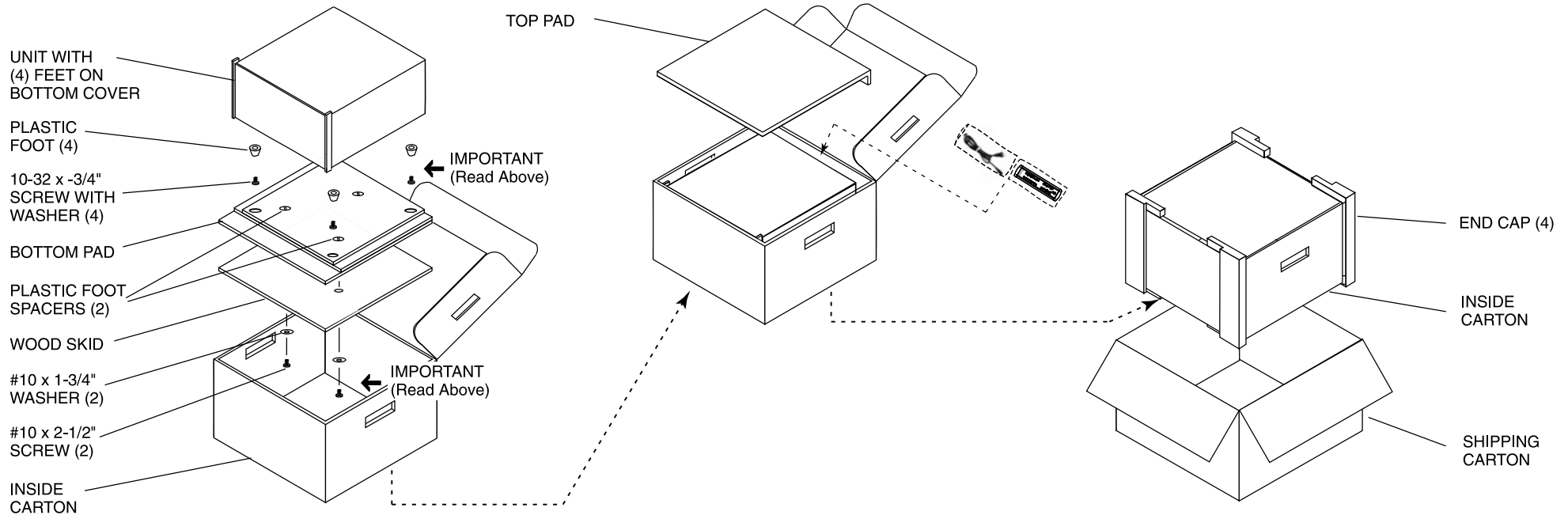



McIntosh Laboratory, Inc.
2 Chambers Street
Binghamton, NY 13903
www.mcintoshlabs.com

The continuous improvement of its products is the policy of McIntosh Laboratory Incorporated who reserve the right to improve design without notice.
Printed in the U.S.A.