

2-FRONT

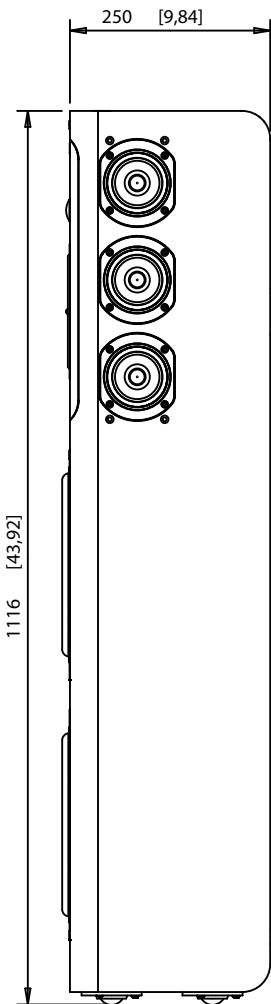

3-RIGHT

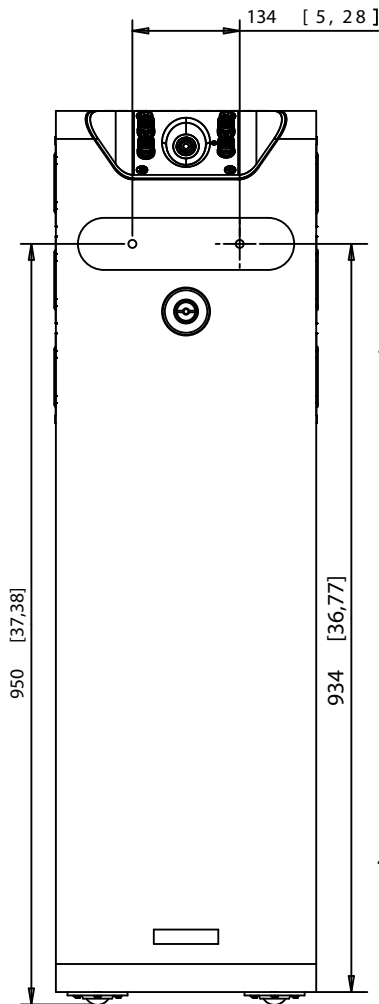

6-BACK

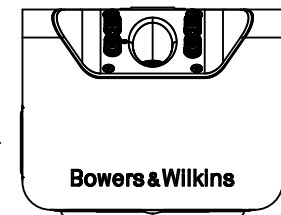

5-TOP

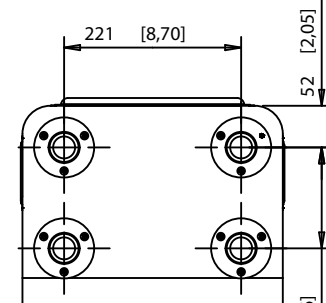

4-BOTTOM

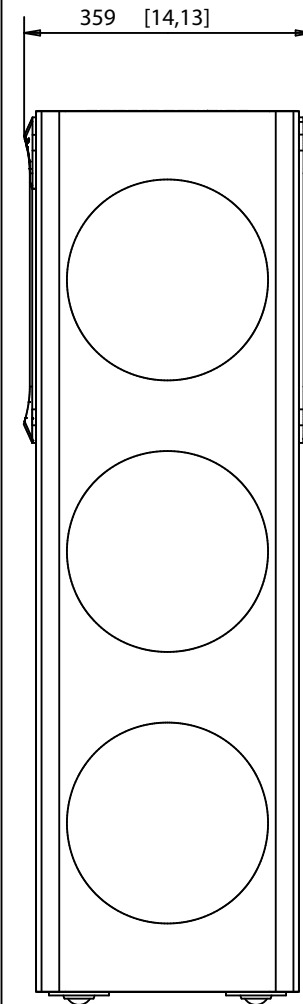

7-FRONT

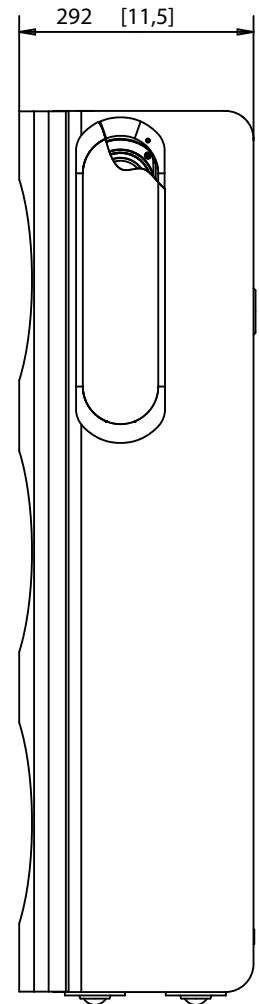

8-RIGHT

GRILLE OFF

GRILLE ON

DIMS IN [BRACKETS] ARE INCHES

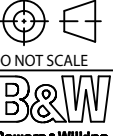
| | | | | | |
|---|--|--|--|--|--|
|  <p>DO NOT SCALE</p> | <p>DIMENSIONS IN mm</p> <p>TOLERANCES</p> <p>0. ± 0.5</p> <p>0.0 ± 0.3</p> <p>0.00 ± 0.1</p> <p>ANGLES ± 0.5°</p> <p>UNLESS OTHERWISE STATED</p> | <p>MATERIAL</p> <p>N/A</p> | <p>4 DIMENSIONS IN INCHES ADDED</p> <p>15.11.05 MG</p> | <p>COPYRIGHT © 2004</p> | <p>PART NO.</p> <p>FP22519</p> |
| | <p>FINISH</p> <p>N/A</p> | <p>3 GRILLE ON VIEWS ADDED</p> <p>20.4.05 MG</p> | <p>ISS</p> <p>AMENDMENT</p> <p>ECN NO.</p> <p>DATE</p> <p>APPROVAL</p> | <p>DRAWN</p> <p>KW</p> <p>DATE</p> <p>28.06.04</p> <p>CHECKED / APPROVED</p> | <p>SCALE</p> <p>NTS</p> <p>FULL DRG SIZE</p> <p>A3</p> |
| <p>TITLE</p> <p>CT8 DS LINE DRAWING</p> | | | <p>ISS</p> <p>4</p> | | |